

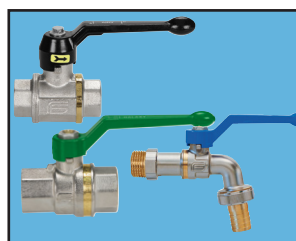

HANDBÓK 2024

Vatnslagnir, fittings ofl.

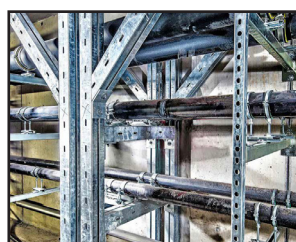

LOFT & RAFTÆKI
loft.is



Vatnsocka
vatnsocka.is



Hjallabrekka 1 - Dalbrekkumegin | 200 Kópavogur | S: 564 3000



Sjó- og krapalagnir

KRYOCLIM





Rör - 4 m.

Vörunúmer	Gerð	Ø stærð
TUBF20	DN15°	20
TUBF25	DN20 max 12,5 bar	25
TUBF32	DN25	32
TUBF40	DN32 max 12,5 bar	40
TUBF50	DN40	50
TUBF63	DN50	63
TUBF75	DN65	75
TUBF90	DN80	90
TUBF110	DN100	110
TUBF160		160
TUBF200		200



Hné 90°

Vörunúmer	Gerð	Ø stærð
F4M20	-30 til 40 °c	20
F4M25	-30 til 40 °c	25
F4M32	-30 til 40 °c	32
F4M40	-30 til 40 °c	40
F4M50	-30 til 40 °c	50
F4M63	-30 til 40 °c	63
F4M75	-30 til 40 °c	75
F4M90	-30 til 40 °c	90
F4M110	-30 til 40 °c	110
F4M160	-30 til 40 °c	160
F4M200	-30 til 40 °c	200



Hné 45°

Vörunúmer	Gerð	Ø stærð
F8M20	-30 til 40 °c	20
F8M25	-30 til 40 °c	25
F8M32	-30 til 40 °c	32
F8M40	-30 til 40 °c	40
F8M50	-30 til 40 °c	50
F8M63	-30 til 40 °c	63
F8M75	-30 til 40 °c	75
F8M90	-30 til 40 °c	90
F8M110	-30 til 40 °c	110
F8M160	-30 til 40 °c	160
F8M200	-30 til 40 °c	200



Té tengi

Vörunúmer	Gerð	Ø stærð
FTE20	Té tengi -30 til 40 °c	20
FTE25	Té tengi -30 til 40 °c	25
FTE32	Té tengi -30 til 40 °c	32
FTE40	Té tengi -30 til 40 °c	40
FTE50	Té tengi -30 til 40 °c	50
FTE63	Té tengi -30 til 40 °c	63
FTE75	Té tengi -30 til 40 °c	75
FTE90	Té tengi -30 til 40 °c	90
FTE110	Té tengi -30 til 40 °c	110
FTE160	Té tengi -30 til 40 °c	160
FTE200	Té tengi -30 til 40 °c	200



Té tengi - minnkandi

Vörunúmer	Gerð	Ø stærð
FTR2520	Té tengi	Ø25/20
FTR3220	Té tengi	Ø32/20
FTR3225	Té tengi	Ø32/25
FTR4020	Té tengi	Ø40/20
FTR4025	Té tengi	Ø40/25
FTR4032	Té tengi	Ø40/32
FTR5020	Té tengi	Ø50/20
FTR5025	Té tengi	Ø50/25
FTR5032	Té tengi	Ø50/32
FTR5040	Té tengi	Ø50/40
FTR6320	Té tengi	Ø63/20
FTR6325	Té tengi	Ø63/25
FTR6332	Té tengi	Ø63/32
FTR6340	Té tengi	Ø63/40
FTR6350	Té tengi	Ø63/50
FTR7525	Té tengi	Ø75/25
FTR7532	Té tengi	Ø75/32
FTR9050	Té tengi	Ø90/50
FTR1132	Té tengi	Ø110/32
FTR1190	Té tengi	Ø110/90



Samtengi

Vörunúmer	Gerð	Ø stærð
FMA20	-30 til 40 °c	25
FMA25	-30 til 40 °c	25
FMA32	-30 til 40 °c	32
FMA40	-30 til 40 °c	40
FMA50	-30 til 40 °c	50
FMA63	-30 til 40 °c	63
FMA75	-30 til 40 °c	75
FMA90	-30 til 40 °c	90
FMA110	-30 til 40 °c	110
FMA160	-30 til 40 °c	160
FMA200	-30 til 40 °c	200



Minnkun

Vörunúmer	Gerð	Ø stærð
FRD3220	Minnkun	Ø32/20
FRD4020	Minnkun	Ø40/20
FRD4025	Minnkun	Ø40/25
FRD5032	Minnkun	Ø50/32
FRD6325	Minnkun	Ø63/25
FRD6332	Minnkun	Ø63/32
FRD6340	Minnkun	Ø63/40
FRD7540	Minnkun	Ø75/40
FRD7550	Minnkun	Ø75/50
FRD9040	Minnkun	Ø90/40
FRD9050	Minnkun	Ø90/50
FRD9063	Minnkun	Ø90/63
FRD1150	Minnkun	Ø110/50
FRD1163	Minnkun	Ø110/63
FRD1175	Minnkun	Ø110/75
FRD1675	Minnkun	Ø160/75
FRD1690	Minnkun	Ø160/90
FRD1611	Minnkun	Ø160/110



Té tengi m/gengju 1/2"

Vörunúmer	Gerð	Ø stærð
FTGRL3212	m/gengju 1/2"	32 x 1/2"
FTGRL4012	m/gengju 1/2"	40 x 1/2"
FTGRL5012	m/gengju 1/2"	50 x 1/2"
FTGRL6312	m/gengju 1/2"	63 x 1/2"



Tengi fyrir flans

Vörunúmer	Gerð	Ø stærð
FCS50	Tengi fyrir flans	50
FCS63	Tengi fyrir flans	63
FCS75	Tengi fyrir flans	75
FCS90	Tengi fyrir flans	90
FCS110	Tengi fyrir flans	110
FCS160	Tengi fyrir flans	160
FCS200	Tengi fyrir flans	200



Lok

Vörunúmer	Gerð	Ø stærð
FBO20	Lok	20
FBO25	Lok	25
FBO32	Lok	32
FBO40	Lok	40
FBO50	Lok	50
FBO63	Lok	63
FBO75	Lok	75
FBO90	Lok	90
FBO110	Lok	110
FBO160	Lok	160



Minnkun

Vörunúmer	Gerð	Ø stærð
FRS25	Minnkun	25/20
FRS32	Minnkun	32/25
FRS40	Minnkun	40/32
FRS50	Minnkun	50/40
FRS63	Minnkun	63/50
FRS75	Minnkun	75/63
FRS90	Minnkun	90/75
FRS110	Minnkun	110/90
FRS200	Minnkun	200/160



Union

Vörunúmer	Gerð	Ø stærð
F3P20	Union	20
F3P25	Union	25
F3P32	Union	32
F3P40	Union	40
F3P50	Union	50
F3P63	Union	63



Nippiltengi

Vörunúmer	Gerð	Ø stærð
FEAL20	20/25 x 1/2"	20
FEAL25	25/32 x 3/4"	25
FEAL32	32/40 x 1"	32
FEAL40	40/50 x 1 1/4"	40
FEAL50	50/63 x 1 1/2"	50
FEAL63	63/75 x 2"	63
FEAL75	75/90 x 2 1/2"	75
FEAL90	90/110 x 3"	90



Múffutengi

Vörunúmer	Gerð	Ø stærð
FMML20	20/25 x 1/2"	20
FMML25	25/32 x 3/4"	25
FMML32	32/40 x 1"	32
FMML40	40/50 x 1 1/4"	40
FMML50	50/63 x 1 1/2"	50
FMML63	63/75 x 2"	63
FMML75	75/90 x 2 1/2"	75
FMML90	90/110 x 3"	90



Union - einf.minkun

Vörunúmer	Gerð	Ø stærð
F3G/L20	20 x 1/2"	20
F3G/L25	25 x 3/4"	25
F3G/L32	32 x 1"	32
F3G/L40	40 x 1 1/4"	40
F3G/L50	50 x 1 1/2"	50
F3G/L63	63 x 2"	63



Union

Vörunúmer	Gerð	Ø stærð
F3F/L20	20 x 1/2"	20
F3F/L25	25 x 3/4"	25
F3F/L32	32 x 1"	32
F3F/L40	40 x 1 1/4"	40
F3F/L50	50 x 1 1/2"	50
F3F/L63	63 x 2"	63



Loki

Vörunúmer	Gerð	Ø stærð
VFFEP75	Loki	75
VFFEP90	Loki	90
VFFEP110	Loki	110



Loki

Vörunúmer	Gerð	Ø stærð
VFCEP20	Loki	20
VFCEP25	Loki	25
VFCEP32	Loki	32
VFCEP40	Loki	40
VFCEP50	Loki	50
VFCEP63	Loki	63



Samtengi m/gengju 3/4"

Vörunúmer	Gerð	Ø stærð
FMIL110/34	m/gengju 3/4"	110
FMIL160/34	m/gengju 3/4"	160



Hné m/gengju 1/2"

Vörunúmer	Gerð	Ø stærð
F4MI5012	Hné m/gengju 1/2"	50
F4MI6312	Hné m/gengju 1/2"	63



Hné - langt

Vörunúmer	Gerð	Ø stærð
F4C50	Stórt hné	50
F4C63	Stórt hné	63



Straum té

Vörunúmer	Gerð	Ø stærð
FYT50	Straum té	50
FYT63	Straum té	63



Samtengi m/gengju 1/2"

Vörunúmer	Gerð	Ø stærð
FMIL110/12	m/gengju 1/2"	110
FMIL160/12	m/gengju 1/2"	160



Flange tengi

Vörunúmer	Gerð	Ø stærð
BPA40	Flange tengi	50 x 40
BPA50	Flange tengi	63 x 50
BPA60	Flange tengi	63 x 60
BPA65	Flange tengi	75 x 60
BPA80	Flange tengi	90 x 80
BPA100	Flange tengi	110 x 100
BPA125	Flange tengi	125 x 125
BPA140	Flange tengi	140 x 125





























Lím

Vörunúmer	Gerð	Ø stærð
HPFIX	p	250 ml.
HPFIX	b	1 l.



Primer - Hreinsir

Vörunúmer	Gerð	Ø stærð
CLEANER+	Hreinsir	1 L.

Vöruheiti	Vörunúmer	Ø 20	Ø 25	Ø 32	Ø 40	Ø 50	Ø 63	Ø 75	Ø 90	Ø 110	Ø 160	Ø 200
 Rör - 4 m.	TUBF	20	25	32	40	50	63	75	90	110	160	200
 Hné 90° -30 til 40 °c	F4M	20	25	32	40	50	63	75	90	110	160	200
 Hné 45° -30 til 40 °c	F8M	20	25	32	40	50	63	75	90	110	160	200
 Samtengi -30 til 40 °c	FMA	20	25	32	40	50	63	75	90	110	160	200
 Té tengi -30 til 40 °c	FTE	20	25	32	40	50	63	75	90	110	160	200
 Té tengi -30+40°	FTR		20	20	20	20	20	20	25	25		
				25	25	25	25	25	32	32		
					32	32	32	32	40	40		
						40	40	40	50	50		
							50	50	63	63		
								63	75	75		
										90		
 Lok din	FBO	20	25	32	40	50	63	75	90	110	160	200
 Rörbútur	FMC	20	25									
 Tengir fyrir flans	FCS					50	63	75	90	110	160	200
 Té tengi - 1/2"	FTFRL			32	40	50	63					
 Té tengi - 3/4"	FTFRL			32	40	50	63					
 Té tengi m/gengju - 1/2"	FTGRL			32	40	50	63					
 Einf.minkun	FRS			32	40	50	63	75	90	110		160
 Minkun	FRD			20	20	32	25	40	40	50	75	
					25		32	50	50	63	90	
							40		63	75	110	
 Union -30 til 40 °c	F3P	20	25	32	40	50						
 Union kopar út -30-40°c	F3F/L	1/2"	3/4"	1"	1 1/4"	1 1/2"	2"					
 Union kopar -30 til 40 °c	F3G/L	1/2"	3/4"	1"	1 1/4"	1 1/2"	2"					
 Múffutengi - beint tengi - inn	FMML	20	25	32	40	50	63	75	90	110	160	200
 Nippiltengi - beint tengi - út	FEAL	20	25	32	40	50	63	75	90	110	160	200
 Hné m/gengju 1/2"	F4MI					50	63					
 Samtengi m/gengju - 1/2"	FMIL									110	160	
 Samtengi m/gengju - 3/4"	FMIL									110	160	
 Hné - langt	F4C					50	63					
 Streum té	FYT					50	63					
 Kúluloki	VFCEP	20	25	32	40	50	63					
 Kúluloki	VFFEP							75	90	110		
 Lím	HPTIX	250 ml.	1 l.									



Neysluvatnslagnir

HTA®



LÁMARKAR
BAKTERÍUMYNDUN Í
NEYSLUVATNSLÖGNUM



Rör - 3 og 4 m.

Vörunúmer	Gerð	Ø stærð
TUHTAF16	3 m - fyrir kalt vatn	16
TUHTAF20	3 m - fyrir kalt vatn	20
TUHTAF25	3 m - fyrir kalt vatn	25
TUHTAF32	3 m - fyrir kalt vatn	32
TUHTAF40	3 m - fyrir kalt vatn	40
TUHTAF50	3 m - fyrir kalt vatn	50
TUHTAF63	4 m - fyrir kalt vatn	63
TUHTAF75	4 m - fyrir kalt vatn	75
TUHTAF90	4 m - fyrir kalt vatn	90
TUHTAF110	4 m - fyrir kalt vatn	110
TUHTAF125	4 m - fyrir kalt vatn	125
TUHTAF160	4 m - fyrir kalt vatn	160

Rör - 3-4 m.

Vörunúmer	Gerð	Ø stærð
TUBHT63	4 m - fyrir 16 bör þrýsting	63
TUBHT75	4 m - fyrir 16 bör þrýsting	75
TUBHT90	4 m - fyrir 16 bör þrýsting	90
TUBHT110	4 m - fyrir 16 bör þrýsting	110
TUBHT125	4 m - fyrir 16 bör þrýsting	125
TUBHT160	4 m - fyrir 16 bör þrýsting	160
THT2516	3 m - fyrir 16 bör þrýsting	25
THT3216	3 m - fyrir 16 bör þrýsting	32
THT4016	3 m - fyrir 16 bör þrýsting	40
THT5016	3 m - fyrir 16 bör þrýsting	50

Rör - 3-4 m.

Vörunúmer	Gerð	Ø stærð
TUBHT163	3 m - fyrir 25 bör þrýsting	16
TUBHT203	3 m - fyrir 25 bör þrýsting	20
TUBHT253	3 m - fyrir 25 bör þrýsting	25
TUBHT323	3 m - fyrir 25 bör þrýsting	32
TUBHT403	3 m - fyrir 25 bör þrýsting	40
TUBHT503	3 m - fyrir 25 bör þrýsting	50
THT6325	4 m - fyrir 25 bör þrýsting	63

Rörbútur

Vörunúmer	Gerð	Ø
HMC16	16 x 33 mm	16
HMC20	20 x 37 mm	20
HMC25	25 x 42 mm	25
HMC32	32 x 49 mm	32
HMC40	40 x 57 mm	40
HMC50	50 x 67 mm	50
HMC63	63 x 80 mm	63
HMC75	75 x 92 mm	75
TUBHT901M	90 x 1000 mm	90
TUBHT1101M	110 x 1000 mm	110
TUBHT1251M	125 x 1000 mm	125
TUBHT1601M	160 x 1000 mm	160

Hné 90°

Vörunúmer	Gerð	Ø stærð
H4M16	Hné 90°	16
H4M20	Hné 90°	20
H4M25	Hné 90°	25
H4M32	Hné 90°	32
H4M40	Hné 90°	40
H4M50	Hné 90°	50
H4M63	Hné 90°	63
H4M75	Hné 90°	75
H4M90	Hné 90°	90
H4M110	Hné 90°	110
H4M125	Hné 90°	125
H4M160	Hné 90°	160

Hálfhné 45°

Vörunúmer	Gerð	Ø stærð
H8M16	Hálfhné 45°	16
H8M20	Hálfhné 45°	20
H8M25	Hálfhné 45°	25
H8M32	Hálfhné 45°	32
H8M40	Hálfhné 45°	40
H8M50	Hálfhné 45°	50
H8M63	Hálfhné 45°	63
H8M75	Hálfhné 45°	75
H8M90	Hálfhné 45°	90
H8M110	Hálfhné 45°	110
H8M125	Hálfhné 45°	125
H8M160	Hálfhné 45°	160

Samtengi

Vörunúmer	Gerð	Ø stærð
HMA16	Samtengi	16
HMA20	Samtengi	20
HMA25	Samtengi	25
HMA32	Samtengi	32
HMA40	Samtengi	40
HMA50	Samtengi	50
HMA63	Samtengi	63
HMA75	Samtengi	75
HMA90	Samtengi	90
HMA110	Samtengi	110
HMA125	Samtengi	125
HMA160	Samtengi	160

Minnkun

Vörunúmer	Gerð	Ø stærð
HRD25/16	Minnkun	Ø 25/16
HRD32/16	Minnkun	Ø 32/16
HRD32/20	Minnkun	Ø 32/20
HRD40/16	Minnkun	Ø 40/16
HRD40/20	Minnkun	Ø 40/20
HRD40/25	Minnkun	Ø 40/25
HRD50/20	Minnkun	Ø 50/20
HRD50/25	Minnkun	Ø 50/25
HRD50/32	Minnkun	Ø 50/32
HRD63/20	Minnkun	Ø 63/20
HRD63/25	Minnkun	Ø 63/25
HRD63/32	Minnkun	Ø 63/32
HRD63/40	Minnkun	Ø 63/40
HRD75/20	Minnkun	Ø 75/20
HRD75/25	Minnkun	Ø 75/25
HRD75/32	Minnkun	Ø 75/32
HRD75/40	Minnkun	Ø 75/40
HRD75/50	Minnkun	Ø 75/50
HRD90/25	Minnkun	Ø 90/25
HRD90/32	Minnkun	Ø 90/32
HRD90/40	Minnkun	Ø 90/40
HRD90/50	Minnkun	Ø 90/50
HRD90/63	Minnkun	Ø 90/63
HRD11/50	Minnkun	Ø 110/50
HRD11/63	Minnkun	Ø 110/63
HRD11/75	Minnkun	Ø 110/75
HRD12/90	Minnkun	Ø 125/90
HRD16/75	Minnkun	Ø 160/75
HRD16/90	Minnkun	Ø 160/90
HRD16/11	Minnkun	Ø 160/110
HRD16/12	Minnkun	Ø 160/125

Minnkun

Vörunúmer	Gerð	Ø stærð
HRS20	20/16	20
HRS25	25/20	25
HRS32	32/25	32
HRS40	40/32	40
HRS50	50/40	50
HRS63	63/50	63
HRS75	75/63	75
HRS90	90/75	90
HRS110	110/90	110
HRS125	125/110	125

Minnkun

Vörunúmer	Gerð	Ø stærð
HRDC1263	125/63	63
HRDC1275	125/75	75
HRDC1611	160/110	110
HRDC1612	160/125	125

Lok

Vörunúmer	Gerð	Ø stærð
HBO16	Lok	16
HBO20	Lok	20
HBO25	Lok	25
HBO32	Lok	32
HBO40	Lok	40
HBO50	Lok	50
HBO63	Lok	63
HBO75	Lok	75
HBO90	Lok	90
HBO110	Lok	110
HBO125	Lok	125
HBO160	Lok	160

Vegghné

Vörunúmer	Gerð	Ø stærð
H4GP16	16 x 1/2"	16
H4GP20	20 x 1/2"	20
H4GP25	25 x 3/4"	25

Hné - langt

Vörunúmer	Gerð	Ø stærð
H4C16	Hné - langt	16
H4C20	Hné - langt	20
H4C25	Hné - langt	25
H4C32	Hné - langt	32
H4C40	Hné - langt	40
H4C50	Hné - langt	50
H4C63	Hné - langt	63

Múffa

Vörunúmer	Gerð	Ø stærð
HFT25	25 x 1/2"	25
HFT32	32 x 3/4"	32



Múffutengi

Vörunúmer	Gerð	Ø stærð
HMML16	16/20 x 3/8"	16
HMML20	20/25 x 1/2"	20
HMML25	25/32 x 3/4"	25
HMML32	32/40 x 1"	32
HMML40	40/50 x 1 1/4"	40
HMML50	50/63 x 1 1/2"	50
HMML63	63/75 x 2"	63
HMML75	75/90 x 2 1/2"	75
HMML90	90/110 x 3"	90



Múffutengi

Vörunúmer	Gerð	Ø stærð
HMMS20	20/25 x 1/2"	20
HMMS25	25/32 x 3/4"	25
HMMS323	32/40 x 1"	32



Múffutengi

Vörunúmer	Gerð	Ø stærð
HMM20	20/25 x 1/2"	20
HMM25	25/32 x 3/4"	25
HMM32	32/40 x 1"	32
HMM40	40/50 x 1 1/4"	40
HMM50	50/63 x 1 1/2"	50
HMM63	63/75 x 2"	63



Múffuhné

Vörunúmer	Gerð	Ø stærð
H4GL16	16 x 1/2"	16
H4GL20	20 x 1/2"	20
H4GL25	25 x 3/4"	25



Té - minkandi í miðstút

Vörunúmer	Gerð	Ø stærð
HTR20/16	Té tengi	20/16
HTR25/16	Té tengi	25/16
HTR25/20	Té tengi	25/20
HTR32/16	Té tengi	32/16
HTR32/20	Té tengi	32/20
HTR32/25	Té tengi	32/25
HTR40/20	Té tengi	40/20
HTR40/25	Té tengi	40/25
HTR40/32	Té tengi	40/32
HTR50/20	Té tengi	50/20
HTR50/25	Té tengi	50/25
HTR50/32	Té tengi	50/32
HTR50/40	Té tengi	50/40
HTR63/20	Té tengi	63/20
HTR63/25	Té tengi	63/25
HTR63/32	Té tengi	63/32
HTR63/40	Té tengi	63/40
HTR63/50	Té tengi	63/50
HTR75/20	Té tengi	75/20
HTR75/25	Té tengi	75/25
HTR75/32	Té tengi	75/32
HTR75/40	Té tengi	75/40
HTR75/50	Té tengi	75/50
HTR75/63	Té tengi	75/63
HTR90/32	Té tengi	90/32
HTR90/40	Té tengi	90/40
HTR90/50	Té tengi	90/50
HTR90/63	Té tengi	90/63
HTR90/75	Té tengi	90/75
HTR11/40	Té tengi	110/40
HTR11/50	Té tengi	110/50
HTR11/63	Té tengi	110/63
HTR11/75	Té tengi	110/75
HTR11/90	Té tengi	110/90



Nippiltengi

Vörunúmer	Gerð	Ø stærð
HEAS20	20/25 x 1/2"	20
HEAS25	25/32 x 3/4"	25
HEAS32	32/40 x 1"	32



Nippiltengi

Vörunúmer	Gerð	Ø stærð
HEA20	20 x 1/2"	20
HEA25	25 x 3/4"	25
HEA32	32 x 1"	32
HEA40	40 x 1 1/4"	40
HEA50	50 x 1 1/2"	50
HEA63	63 x 2"	63



Té tengi

Vörunúmer	Gerð	Ø stærð
HTE16	Té tengi	16
HTE20	Té tengi	20
HTE25	Té tengi	25
HTE32	Té tengi	32
HTE40	Té tengi	40
HTE50	Té tengi	50
HTE63	Té tengi	63
HTE75	Té tengi	75
HTE90	Té tengi	90
HTE110	Té tengi	110
HTE125	Té tengi	125
HTE160	Té tengi	160



Nippiltengi

Vörunúmer	Gerð	Ø stærð
HEBL16	16/20 x 1/2"	16
HEBL20	20/25 x 3/4"	20
HEBL25	25/32 x 1"	25



Nippiltengi

Vörunúmer	Gerð	Ø stærð
HEB16	16 x 1/2"	16
HEB20	20 x 3/4"	25
HEB25	25 x 1"	25
HEB32	32 x 1 1/4"	32
HEB40	40 x 1 1/2"	40
HEB50	50 x 2"	50



Té tengi

Vörunúmer	Gerð	Ø stærð
HTGRL3212	32 x 1/2"	32
HTGRL4012	40 x 1/2"	40
HTGRL5012	50 x 1/2"	50
HTGRL6312	63 x 1/2"	63



Té tengi

Vörunúmer	Gerð	Ø stærð
HTG16	16 x 1/2"	16
HTG20	20 x 1/2"	20
HTG25	25 x 3/4"	25



Nippiltengi

Vörunúmer	Gerð	Ø stærð
HEAL16	16/20 x 3/8"	16
HEAL20	20/25 x 1/2"	20
HEAL25	25/32 x 3/4"	25
HEAL32	32/40 x 1"	32
HEAL40	40/50 x 1 1/4"	40
HEAL50	50/63 x 1 1/2"	50
HEAL63	63/75 x 2"	63
HEAL75	75/90 x 2 1/2"	75
HEAL90	90/110 x 3"	90



Té tengi

Vörunúmer	Gerð	Ø stærð
HTGRL3234	32 x 3/4"	32
HTGRL4034	40 x 3/4"	40
HTGRL5034	50 x 3/4"	50
HTGRL6334	63 x 3/4"	63



Té tengi

Vörunúmer	Gerð	Ø stærð
HTGR4034	40 x 3/4"	40
HTGR5034	50 x 3/4"	50
HTGR6334	63 x 3/4"	63

Union

Vörunúmer	Gerð	Ø stærð
H3P16	Union	16
H3P20	Union	20
H3P25	Union	25
H3P32	Union	32
H3P40	Union	40
H3P50	Union	50
H3P63	Union	63

Union m/pakkningu

Vörunúmer	Gerð	Ø stærð
HDR16	16 x 1/2"	16
HDR20	20 x 3/4"	20
HDR25	25 x 1"	25
HDR32	32 x 1 1/4"	32
HDR40	40 x 1 1/2"	40
HDR50	50 x 2"	50

Union-Nippill

Vörunúmer	Gerð	Ø stærð
H3F/L16	16 x 3/8"	16
H3F/L20	20 x 1/2"	20
H3F/L25	25 x 3/4"	25
H3F/L32	32 x 1"	32
H3F/L40	40 x 1 1/4"	40
H3F/L50	50 x 1 1/2"	50
H3F/L63	63 x 2"	63

Union-Múffa

Vörunúmer	Gerð	Ø stærð
H3G/L16	16 x 3/8"	16
H3G/L20	20 x 1/2"	20
H3G/L25	25 x 3/4"	25
H3G/L32	32 x 1"	32
H3G/L40	40 x 1 1/4"	40
H3G/L50	50 x 1 1/2"	50
H3G/L63	63 x 2"	63

Union-Nippill

Vörunúmer	Gerð	Ø stærð
H3F/PB16	16 x 1/2"	16
H3F/P20	20 x 1/2"	20
H3F/PB20	20 x 3/4"	20
H3F/P25	25 x 3/4"	25
H3F/PB25	25 x 1"	25

Slöngustútur

Vörunúmer	Gerð	Ø stærð
HDC16	Slöngustútur	16
HDC20	Slöngustútur	20
HDC25	Slöngustútur	25
HDC32	Slöngustútur	32
HDC40	Slöngustútur	40
HDC50	Slöngustútur	50

Kúluloki

Vörunúmer	Gerð	Ø stærð
VHCEP16	Kúluloki	16
VHCEP20	Kúluloki	20
VHCEP25	Kúluloki	25
VHCEP32	Kúluloki	32
VHCEP40	Kúluloki	40
VHCEP50	Kúluloki	50
VHCEP63	Kúluloki	63

Kúluloki

Vörunúmer	Gerð	Ø stærð
VHFEP75	Kúluloki	75
VHFEP90	Kúluloki	90
VHFEP110	Kúluloki	110

Einstefnuloki

Vörunúmer	Gerð	Ø stærð
HCB3P20	Einstefnuloki	20
HCB3P25	Einstefnuloki	25
HCB3P32	Einstefnuloki	32
HCB3P40	Einstefnuloki	40

Pennslumuffa

Vörunúmer	Gerð	Ø stærð
HCOMP32	Pennslumuffa	32
HCOMP40	Pennslumuffa	40
HCOMP50	Pennslumuffa	50
HCOMP63	Pennslumuffa	63

Flanse

Vörunúmer	Gerð	Ø stærð
HCS25	Flanse	25
HCS32	Flanse	32
HCS40	Flanse	50
HCS63	Flanse	63
HCS75	Flanse	75
HCS90	Flanse	90
HCS110	Flanse	110
HCS125	Flanse	125
HCS160	Flanse	160

Lím







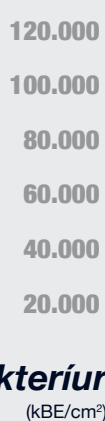

















Vörunúmer	Gerð
HTAFUSIONP	250 ml.
HTAFUSIONB	1 l.





















Primer - Hreinsir

Vörunúmer	Gerð
CLEANER+	1 l.

Rannsókn um bakteríuvöxt í vatnslögnum*

* <https://www.lubrizol.com/CPVC/Sustainability/Live-Better>

Vöruheiti	Vörunúmer	Ø 16	Ø 20	Ø 25	Ø 32	Ø 40	Ø 50	Ø 63	Ø 75	Ø 90	Ø 110	Ø 125	Ø 160
 Rör - 3 m. fyrir kalt vatn	TUHTAF	16	20	25	32	40	50	63	75	90	110	125	160
 Rör - 4 m. fyrir kalt vatn	TUHTAF							63	75	90	110	125	160
 Rör - 4 m. fyri 16 bör þrýsting	THT			25	32	40	50	63	75	90	110	125	160
 Rör - 3 m. fyri 25 bör þrýsting	TUBHT	16	20	25	32	40	50						
 Rör - 4 m. fyri 25 bör þrýsting	THT6325							63					
 Rörbútur	HMC	33 mm	37 mm	42 mm	49 mm	57 mm	67 mm	80 mm	92 mm	1000 mm	1000 mm	1000 mm	1000 mm
 Hné 90°	H4M	16	20	25	32	40	50	63	75	90	100	125	160
 Hálfhné 45°	H8M	16	20	25	32	40	50	63	75	90	100	125	160
 Samtengi	HMA	16	20	25	32	40	50	63	75	90	100	125	160
 Minnkun	HRD			16	16	16	20	20	20	25	50	90	75
					20	20	25	25	25	32	63		110
						25		32	32	40	75		125
								40	40	50			
									50	63			
 Minnkun	HRS		16	20	25	32	40	50	63	75	90	110	
 Minnkun	HRDC							125	125		160	160	
 Lok	HBO	16	20	25	32	40	50	63	75	90	100	125	160
 Vegghné	H4GP	1/2"	1/2"	1/2"									
 Hné - langt	HMA	16	20	25	32	40	50	63					
 Múffa	GARD			1/2"	3/4"								
 Múffutengi - beint tengi - inn	HMML	20x3/8"	25x1/2"	32x3/4"	40x1"	50x1 1/4"	63x1 1/2"	75 x 2"	90x2 1/2"	110 x 3"			
 Múffutengi - ryðfritt - inn	HMMS		25x1/2"	32x3/4"	40x1"								
 Múffutengi	HMM		25x1/2"	32x3/4"	40x1"	50x1 1/4"	63x1 1/2"	75 x 2"					
 Múffuhné	H4GL	1/2"	1/2"	3/4"									
 Nippiltengi - ryðfritt - út	HEAS		25x1/2"	32x3/4"	40x1"								
 Nippiltengi - beint tengi - út	HEBL	20x1/2"	25x3/4"	32x1"									
 Nippiltengi - beint tengi - út	HEAL	20x3/8"	25x1/2"	32x3/4"	40x1"	50x1 1/4"	63x1 1/2"	75x2"	90x2 1/2"	110x3"			
 Nippiltengi	HEA		1/2"	3/4"	1"	1 1/4"	1 1/2"	2"					
 Nippiltengi	HEB	1/2"		1"	1 1/4"	1 1/2"	2"						

Vörueiti	Vörunúmer	Ø 16	Ø 20	Ø 25	Ø 32	Ø 40	Ø 50	Ø 63	Ø 75	Ø 90	Ø 110	Ø 125	Ø 160
 Té tengi	HTE	16	20	25	32	40	50	63	75	90	110	125	160
 Té tengi - minkandi i miðstút	HRD		16	16	16	20	20	20	20	32	40		
				16	20	25	25	25	25	40	50		
				20	25	32	32	32	32	50	63		
							40	40	40	63	75		
								50	50	75	90		
									63				
 Té tengi - 1/2"	HTGRL				1/2"	1/2"	1/2"	1/2"					
 Té tengi - 3/4"	HTGRL				3/4"	3/4"	3/4"	3/4"					
 Té tengi	HTG	1/2"	1/2"	1/2"									
 Té tengi m/gengjum	HTGR					3/4"	3/4"	3/4"					
 Union	H3P	16	20	25	32	40	50	63					
 Union-Nippill	H3F/PB	1/2"	1/2"	3/4"									
			3/4"	1"									
 Union	HDR	1/2"	3/4"	1"	1 1/4"	1 1/2"	2"						
 Union-Nippill	H3F/L	3/8"	1/2"	3/4"	1"	1 1/4"	1 1/2"	2"					
 Union-Múffa	H3G/L	3/8"	1/2"	3/4"	1"	1 1/4"	1 1/2"	2"					
 Kúluloki	VHCEP	16	20	25	32	40	50	63					
 Kúluloki	VHFEP								75	90	110	125	160
 Slöngustútur	HDC	16	20	25	32	40	50						
 Flanse	HCS			25	32	40	50	63	75	90	110	125	160
 Flange tengi	HKITCOMP					40	50	63	75	90	110	125	160
 Þennslumuffa	HCOMP				32	40	50	63					
 Einstefnuloki	HCBS		20	25	32	40							
 Veggfestingar	HCKE	16/8"	20/8"	25/8"	32/8"	40/8"	50/8"	63/8"	75/8"	90/8"	110/8"	125/8"	160/8"
 Lim	HTAFUSION	250 ml.		1 l.									



Frárennslislagnir

FRIAPHON



Frárennsliðir

Vörunúmer	Gerð	Lengd / mm	Ø stærð
GPIPE52	Rör	2000	52
GPIPE78	Rör	3000	78
GPIPE110	Rör	3000	110

Hljóðdempanði hné

Vörunúmer	Gerð	Ø stærð
S4PC110	Hné	110

Hné 15°

Vörunúmer	Gerð	Ø stærð
S24M52	Hné 30°	52
S24M78	Hné 30°	78
S24M110	Hné 30°	110

Hné 30°

Vörunúmer	Gerð	Ø stærð
S12M52	Hné 30°	52
S12M78	Hné 30°	78
S12M110	Hné 30°	110

Hné 45°

Vörunúmer	Gerð	Ø stærð
S8M52	Hné 45°	52
S8M78	Hné 45°	78
S8M110	Hné 45°	110

Hné 67°

Vörunúmer	Gerð	Ø stærð
S6M52	Hné 67°	52
S6M78	Hné 67°	78
S6M110	Hné 67°	110

Hné 87°

Vörunúmer	Gerð	Ø stærð
S4M52	Hné 67°	52
S4M78	Hné 67°	78
S4M110	Hné 67°	110

Lok

Vörunúmer	Gerð	Ø stærð
SBO52	Lok	52
SBO78	Lok	78
SBO110	Lok	110

Rörtengi

Vörunúmer	Gerð	Lengd / mm	Ø stærð
SMMF52150	Tengi	150	52
SMMF52250	Tengi	250	52
SMMF78	Tengi	250	78
SMMF110	Tengi	250	110

Tengi með hljóðeinangrun

Vörunúmer	Gerð	Lengd / mm	Ø stærð
SMA52	Tengi	46	52
SMA78	Tengi	54	78
SMA110	Tengi	61,5	110

Minnkun

Vörunúmer	Gerð	mm	Ø stærð
SR7852	Minnkun	70/50	78/52
SR11052	Minnkun	100/50	78/52
SR11078	Minnkun	110/70	110/52

Tengi með stút

Vörunúmer	Gerð	mm	Ø stærð
STA110	Tengi 45°		110
STA11045	Tengi 87°		110

Grein 45°

Vörunúmer	Gerð	mm	Ø stærð
SCS5252	Grein 45°	52/52	52/52
SCS7852	Grein 45°	110/78	78/78
SCS7878	Grein 45°	78/78	78/78
SCS11052	Grein 45°	110/52	110/52
SCS11078	Grein 45°	110/78	110/78
SCS11011	Grein 45°	110/110	110/110

Grein 67°

Vörunúmer	Gerð	mm	Ø stærð
STS11011	Grein 67°	110/110	110/110

Grein 87°

Vörunúmer	Gerð	mm	Ø stærð
STE5252	Grein 87°	52/52	52/52
STE7852	Grein 87°	78/52	78/52
STE7878	Grein 87°	78/78	78/78
STE11052	Grein 87°	110/52	110/52
STE11078	Grein 87°	110/78	110/78
STE11011	Grein 87°	110/110	110/110

Tvöföld grein 67°

Vörunúmer	Gerð	mm	Ø stærð
SCD11045	2 x grein 67°	110/110	110



Millistykki - PVC /PP-HT

Vörunúmer	Gerð	mm	Ø stærð
SAF52	Breytistykki	52/50	52
SAF78	Breytistykki	78/75	78



Millistykki - PVC /PP-HT

Vörunúmer	Gerð	Ø stærð
SJT52	Millistykki	52
SJT78	Millistykki	78



Millistykki - steypujárn

Vörunúmer	Gerð	Ø stærð
SJFF110	Millistykki	110



Þéttingahringur - EPDM

Vörunúmer	Gerð	Ø stærð
JALS52G	Þétting	50,5
JALS78G	Þétting	76
JALS110G	Þétting	108



Rörfestingar - Hljóðdempanði

Vörunúmer	Gerð	mm	Ø stærð
SCA52	Festing - einföld	M8	52
SCA78	Festing - tvöföld	M10	78
SCA110	Festing - tvöföld	M10	110



Rörfestingar - Titringsvörn

Vörunúmer	Gerð	Ø stærð
SCB78	Festing tvöföld (B)	78
SCB110	Festing tvöföld (B)	110



























Rörafesting

Vörunúmer	Gerð	mm	Ø stærð
PH052/8	Rörafesting	M8	52
PH078/8	Rörafesting	M8	78
PH0110/8	Rörafesting	M8	78



Rörafeiti

Vörunúmer	Gerð	magn
SLUB125	Rörafeiti	125 ml

Vöruheiti	Vörunúmer	Ø 52	Ø 78	Ø 90	Ø 110	Ø 135	Ø 160
 Frárennslisör	GEIPE	52	78	90	110	135	160
 Hljóðdempanði hné	S4PC			110			
 Hné 15°	S24M	52	78		110		
 Hné 30°	S12M	52	78		110		
 Hné 45°	S8M	52	78		110		
 Hné 67°	S6M	52	78		110		
 Hné 87°	S4M	52	78		110		
 Lok	SBO	52	78		110		
 Rörtengi	SMMF	52 150 mm 250 mm	78		110 78		
 Tengi með hljóðeinangrun	SMA	52	78	110			
 Minnkun	SR	52 78 110	78 110				
 Tengi með stút - 45° - 87°	STA			110 110			
 Grein 45°	SCS	52 52 110	78	52 78	110		
 Grein 67°	STS			110			
 Grein 87°	SCS	52 52 110	78	52 78	110		
 Tvöföld grein 67°	SDC			110			
 Breytistykki - PVC /PP-HT	SAF	52	78				
 Millistykki - PVC /PP-HT	SJT	52	78				
 Millistykki - steypujárn	SJFF			110			
 Þéttingahringur - EPDM	JALS / G	52	78		110		
 Rörfestingar - Hljóðdempanði	SCA	52	78		110		
 Rörfestingar - Titringsvörn	SCB	52			110		
 Rörafesting	PHO / 8	52	78		110		
 Rörafeiti	SLUB125	125 ml					



Rörafestingar

Vörunúmer	Gerð	Ø stærð
HCKC25/8	25/8	25
HCKC32/8	32/8	32
HCKC40/8	40/8	40
HCKC50/8	50/8	50
HCKC63/8	63/8	63
HCKC75/8	75/8	75
HCKC90/8	90/8	90
HCKC110/8	110/8	110
HCKC125/8	125/8	125
HCKC160/8	160/8	160



Rörafestingar

Vörunúmer	Gerð	Ø stærð
HCKCP25/5	25/5	25



Rörafestingar

Vörunúmer	Gerð	Ø stærð
HCK16/8	16/8 - M8	16
HCK 20/8	20/8 - M8	20



Rörafestingar

Vörunúmer	Gerð	Ø stærð
HCKP16/5	16/5	16
HCKP 20/5	20/5	20



Flange tengi

Vörunúmer	Gerð	Ø stærð
BPA40	50 x 40	40
BPA50	63 x 50	50
BPA60	63 x 60	60
BPA65	75 x 60	65
BPA80	90 x 80	80
BPA100	110 x 100	100
BPA125	125 x 125	125
BPA140	140 x 125	140



Flans í loka HTA®

Vörunúmer	Gerð	Ø stærð
COLVHCEP16		16
COLVHCEP20		20
COLVHCEP25		25
COLVHCEP32		32
COLVHCEP40		40
COLVHCEP50		50
COLVHCEP63		63



Flans í loka GIRAIR®

Vörunúmer	Gerð	Ø stærð
COLGA2MBE16		16
COLGA2MBE20		20
COLGA2MBE25		25
COLGA2MBE32		32
COLGA2MBE40		40
COLGA2MBE50		50
COLGA2MBE63		63



Flans í loka KRYOCLIM®

Vörunúmer	Gerð	Ø stærð
COLVFCEP20		20
COLVFCEP25		25
COLVFCEP32		32
COLVFCEP40		40
COLVFCEP50		50
COLVFCEP63		63



Ró fyrir loka HTA®

Vörunúmer	Gerð	Ø stærð
ECVHCEP1620		16
ECVHCEP1620		20
ECRVHCEP25		25
ECRVHCEP32		32
ECRVHCEP40		40
ECRVHCEP50		50
ECRVHCEP63		63



Ró fyrir loka GIRAIR®

Vörunúmer	Gerð	Ø stærð
ECGA2MBE1620		16
ECGA2MBE1620		20
ECRGA2MBE25		25
ECRGA2MBE32		32
ECRGA2MBE40		40
ECRGA2MBE50		50
ECRGA2MBE63		63



Ró fyrir loka KRYOCLIM®

Vörunúmer	Gerð	Ø stærð
ECRVFCEP20		20
ECRVFCEP25		25
ECRVFCEP32		32
ECRVFCEP40		40
ECRVFCEP50		50
ECRVFCEP63		63



Flange tengi

Vörunúmer	Gerð	Ø stærð
BVR25	32 x 25	25
BVR32B	40 x 32	32
BVR40B	50 x 40	40



Hækkun

Vörunúmer	Ø stærð
CALE2563	25-63



Hækkun

Vörunúmer	Ø stærð
CALE75110	75-110

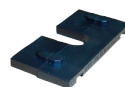

Hækkun

Vörunúmer	Ø stærð
CALE2563	25-63



Hækkun

Vörunúmer	Ø stærð
CALE1220	16-20



Röraskeri

Vörunúmer	Gerð	Ø stærð
CT1240R	Röraskeri	12 til 40 mm
CT1263R	Röraskeri	16 til 63 mm



MÜPRO röraskeri

Vörunúmer	Gerð	Ø stærð
115164	Röraskeri	6 til 67 mm



Yddari

Vörunúmer	Gerð	Ø stærð
CONE50U	Yddari	allt að 50 mm



MGF yddari

Vörunúmer	Gerð	Ø stærð
922983	Yddari	25 til 168 mm
922982	Hníflíðð fyrir yddara	

KALDSUÐA einfalt og fljótlegt

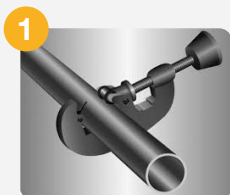

1 Skera

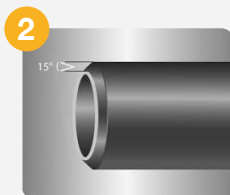

2 Ydda



3 Hreinsa



4 Bera lím á báða fleti



5 Prýst saman

PRÝSTITAFLA

	HTA® Ø 16 to Ø 63 PN 25 Series 4	HTA® Ø 32 to Ø 160 PN 16 Series 6.3	HTA®-F Ø 16 to Ø 160 PN 16
Temperature °C	Working pressure bar	Working pressure bar	Working pressure bar
5	25	16	16
20	25	16	16
40	20	12	
60	13	8	
80	6	4	
90	4	2	
70°C peak for 30 minutes			6

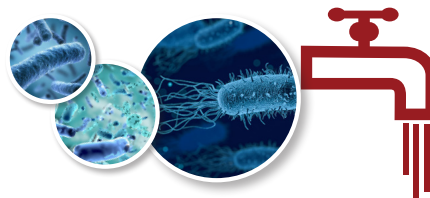

FRÁBÆRT LAGNAEFNI TIL AÐ LÁGMARKA BAKTERÍUMYNDUN Í NEYSLUVATNSLÖGNUM

Margar prófarnir hafa verið framkvæmdar í Evrópu til traustastofum til að meta áhrif sýklaskán á mismunandi tegundir efna.

Rannsóknir sýna að C-PVC (sem HTA samanstendur af) er eitt þeirra efna sem stuðla minnst að lífrænni filmumyndun. Bakteríumyndun er mun minni en í öðrum sambærilegum lagnaefnum.



RYÐFRÍR PRESSFITTINGS

<A> Press Inox press (316)



Conex | Bänninger



90° Street Elbow
Nippil 90° hné

Vörunúmer	Stærð	L	L1	Z
PS26001 0150000	15	45	52	25
PS26001 0180000	18	50	57	30
PS26001 0220000	22	57	70	36
PS26001 0280000	28	68.5	76	45.5
PS26001 0350000	35	73.5	90	47.5
PS26001 0420000	42	85	100	55
PS26001 0540000	54	104	121	69



90° Elbow
Hné 90°

Vörunúmer	Stærð	L	Z
PS26002 0150000	15	45	25
PS26002 0180000	18	50	30
PS26002 0220000	22	57	36
PS26002 0280000	28	68.5	45.5
PS26002 0350000	35	73.5	47.5
PS26002 0420000	42	85	55
PS26002 0540000	54	104	69



CxFi 90° Swivel Connector
Hné 90° með hlauþró

Vörunúmer	Stærð	L	L1	Z	S
PS26002G0150400	15 x 1/2"	45	38	25	24
PS26002G0180400	18 x 1/2"	50	43	30	24
PS26002G0220600	22 x 3/4"	57	47	36	30
PS26002G0280800	28 x 1"	68	58.5	45	37
PS26002G0351000	35 x 1 1/4"	73.5	65	47.5	46
PS26002G0421200	42 x 1 1/2"	85.5	83	55.5	52.5
PS26002G0541600	54 x 2"	116	106	81	64



45° Obtuse Street Elbow
Hálf-hné 45°

Vörunúmer	Stærð	L	L1	Z
PS26040 0150000	15	39	48	19
PS26040 0180000	18	39	48	19
PS26040 0220000	22	45	56	24
PS26040 0280000	28	52	60	29
PS26040 0350000	35	58	68	32
PS26040 0420000	42	70	78	40
PS26040 0540000	54	83	92	48

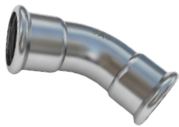

45° Obtuse Elbow
Nippil - hálfhné 45°

Vörunúmer	Stærð	L	Z
PS26041 0150000	15	36	16
PS26041 0180000	18	36	16
PS26041 0220000	22	42	21
PS26041 0280000	28	52	29
PS26041 0350000	35	58	32
PS26041 0420000	42	70	40
PS26041 0540000	54	75	40



Full Crossover Coupler
Yfirbeygja

Vörunúmer	Stærð	L	Z	H
PS26085 0150000	15	167	127	12.5
PS26085 0180000	18	186	146	14
PS26085 0220000	22	203	161	16
PS26085 0280000	28	227.5	181.5	20.5

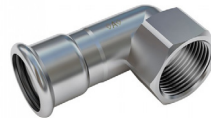

CxFi 90° Elbow ISO - 7
Hné-Múffa - 90°

Vörunúmer	Stærð	L	L1	Z	Z1	S
PS26090G-						
-0150400	15 x 1/2"	53.5	26.5	33.5	15.5	26
-0180400	18 x 1/2"	53.7	25.7	33.7	15.5	26
-0220400	22 x 1/2"	53.7	25.7	32.7	15.5	26
-0220600	22 x 3/4"	61	31	40	16.5	32
-0280800	28 x 1"	69.5	35	46.5	20	38
-0351000	35 x 1 1/4"	77.5	40	51.5	21.5	48



CxMi 90° Elbow ISO - 7
Hné-Nippill - 90°

Vörunúmer	Stærð	L	L1	Z	Z1	S
PS26092G-						
-0150400	15 x 1/2"	59	37	39	21	24.5
-0180400	18 x 1/2"	61	37	41	21	24.5
-0220600	22 x 3/4"	62.5	46	41.5	29.5	28
-0280800	28 x 1"	71	54	48	35	34
-0351000	35 x 1 1/4"	78	55	52	33	44
-0421200	42 x 1 1/2"	84	60	54	35	50
-0541600	54 x 2"	97.5	65	62.5	38	62



Equal Tee
Té

Vörunúmer	Stærð	L	L1	Z	Z1
PS26130 0151515	15	68	39	14	9.5
PS26130 0181818	18	68	42	14	10.5
PS26130 0222222	22	74	45	16	13.5
PS26130 0282828	28	84	52	19	17
PS26130 0353535	35	103	57	25	19.5
PS26130 0424242	42	116	62	28	23
PS26130 0545454	54	140	77	35	29.5



Reduced Branch Tee
Té - minkun

Vörunúmer	Stærð	L	L1	Z	Z2
PS26130 -					
-0181518	18 x 15 x 1 8	68	41.5	14	21.5
-0221522	22 x 15 x 22	74	43	16	23
-0221822	22 x 18 x 22	74	45	16	25
-0281528	28 x 15 x 28	84	46.5	19	26.5
-0281828	28 x 18 x 28	84	48.5	19	28.5
-0282228	28 x 22 x 28	84	48.5	19	27.5
-0351535	35 x 15 x 35	102.5	49	25	29
-0351835	35 x 18 x 35	102.5	51	25	31
-0352235	35 x 22 x 35	102.5	51	25	30
-0352835	35 x 28 x 35	102.5	54.5	25	31.5
-0421542	42 x 15 x 42	116	52.5	28	32.5
-0422242	42 x 22 x 42	116	54.5	28	33.5
-0422842	42 x 28 x 42	116	58	28	35
-0423542	42 x 35 x 42	116	60.5	28	34.5
-0541554	54 x 15 x 54	140	59	35	39
-0542254	54 x 22 x 54	140	61	35	40
-0542854	54 x 28 x 54	140	64.5	35	41.5
-0543554	54 x 35 x 54	140	67	35	41
-0544254	54 x 42 x 54	140	68.5	35	38.5



CxCxFi Branch Tee ISO - 7
Té múffa

Vörunúmer	Stærð	L	L1	Z	S
PS26130G -					
-0150415	15 x 1/2" x 15	34	39.5	14	26
-0180418	18 x 1/2" x 18	34	41	14	26
-0180618	18 x 3/4" x 18	34	42	14	31
-0220422	22 x 1/2" x 22	37	43	16	26
-0220622	22 x 3/4" x 22	37	44	16	31
-0280428	28 x 1/2" x 28	42	46	19	26
-0280628	28 x 3/4" x 28	42	47	19	31
-0280828	28 x 1" x 28	42	51	19	39
-0350435	35 x 1/2" x 35	51	49	25	26
-0350635	35 x 3/4" x 35	51	50	25	31
-0350835	35 x 1" x 35	51	55.5	25	39
-0351035	35 x 1 1/4" x 35	51	55.5	25	48
-0420442	42 x 1/2" x 42	58	52	28	26
-0420642	42 x 3/4" x 42	58	53	28	31
-0420842	42 x 1" x 42	58	57	28	39
-0421242	42 x 1 1/2" x 42	58	61	28	55
-0540454	54 x 1/2" x 54	70	58	35	26
-0540654	54 x 3/4" x 54	70	59	35	31
-0540854	54 x 1" x 54	70	63	35	39
-0541654	54 x 2" x 54	70	73	35	67



CxCxMi Branch Tee ISO - 7
Té nippill

Vörunúmer	Stærð	L	L1	Z	S
PS26133G -					
-0150315	15 x 3/8" x 15	34	34.5	14	19
-0150415	15 x 1/2" x 15	34	40	14	24
-0220622	22 x 3/4" x 22	37	48	16	28
-0280828	28 x 1" x 28	42	52	19	34
-0351035	35 x 1 1/4" x 35	51.2	60	25	44

** The above descriptions reads end, branch, end.



Flange Adaptor PN16
Flans

Vörunúmer	Stærð	L	L1	Z	D	k	d	n
PS26230B -								
- 0150000	15	43	12	23	95	65	14	4
- 0180000	18	43	14	23	95	65	14	4
- 0220000	22	48	14	27	105	75	14	4
- 0280000	28	56	14	33	115	85	14	4
- 0350000	35	60.5	16	34.5	140	100	18	4
- 0420000	42	73	16	43	140	100	18	4
- 0540000	54	89	17	54	165	125	18	4



CxFi Con Flat Seal Face
Hálf-union

Vörunúmer	Stærð	L	Z	S
PS26355 0150400				
15 x 1/2"	52.5	32.5	24	
PS26355 0180600				
18 x 3/4"	52.5	32.5	24	
PS26355 0220600				
22 x 3/4"	54.5	34.5	30	
PS26355 0220800				
22 x 1"	54.5	34.5	24	
PS26355 0280800				
28 x 1"	52.5	32.5	30	
PS26355 0351000				
35 x 1 1/4"	53.5	32.5	30	
PS26355 0421200				
42 x 1 1/2"	60	39	36	
PS26355 0541600				
54 x 2"	83	48	64	



Fitting Reducer
Minkun

Vörunúmer	Stærð	D	L	L1	Z
PS26243 -					
- 0181500	18 x 15	18	66	35.5	46
- 0221500	22 x 15	22	67	32	45
- 0221800	22 x 18	22	66	33	46
- 0281500	28 x 15	28	92	45	68
- 0281800	28 x 18	28	88.5	49	68.5
- 0282200	28 x 22	28	73	40	52
- 0351500	35 x 15	35	90	53	70
- 0351800	35 x 18	35	92.5	53	72.5
- 0352200	35 x 22	35	95	53	74
- 0352800	35 x 28	35	85	58	75
- 0421500	42 x 15	42	92	53	72
- 0422200	42 x 22	42	94	54	73
- 0422800	42 x 28	42	96	52	73
- 0423500	42 x 35	42	93	45	67
- 0541500	54 x 15	54	99	60	79
- 0542200	54 x 22	54	99	60	78
- 0542800	54 x 28	54	102	60	79
- 0543500	54 x 35	54	104	59	78
- 0544200	54 x 42	54	102	50	72



Plug End
Lok

Vörunúmer	Stærð	L	L1
PS26292 0150000			
15	47	42	
PS26292 0220000			
22	53	47.5	
PS26292 0280000			
28	54	49	
PS26292 0350000			
35	59	54	
PS26292 0420000			
42	59	54	
PS26292 0540000			
54	65	60	



CxMi Coupler ISO - 7
Nippiltengi

Vörunúmer	Stærð	D	L	L1	Z
PS26243G -					
- 0150300	15 x 3/8"	54	10.5	34	19
- 0150400	15 x 1/2"	59.5	15	39.5	24
- 0150600	15 x 3/4"	65.5	15.5	45.5	28
- 0180400	18 x 1/2"	61.5	15	41.5	24
- 0180600	18 x 3/4"	65.5	15.5	45.5	28
- 0220400	22 x 1/2"	62.5	15	44.5	24
- 0220600	22 x 3/4"	65.5	15.5	44.5	28
- 0220800	22 x 1"	71	18	50	34
- 0280600	28 x 3/4"	85.1	5.5	62	28
- 0280800	28 x 1"	71	18	48	34
- 0281000	28 x 1 1/4"	81	21	58	44
- 0350800	35 x 1"	71.5	18	45.5	35
- 0351000	35 x 1 1/4"	78.5	21	52.5	44
- 0351200	35 x 1 1/2"	91	23.5	65	50
- 0421000	42 x 1 1/4"	96	21	66	44
- 0421200	42 x 1 1/2"	81	23.5	51	50
- 0541200	54 x 1 1/2"	105.5	23.5	69.5	50
- 0541600	54 x 2"	96.5	25.8	61.5	62



Coupler
Samtengi

Vörunúmer	Stærð	L	Z
PS26270 0150000			
15	48	8	
PS26270 0180000			
18	48	8	
PS26270 0220000			
22	50	8	
PS26270 0280000			
28	56	10	
PS26270 0350000			
35	65	13	
PS26270 0420000			
42	74	14	
PS26270 0540000			
54	86	16	



CxFi Coupler ISO - 7
Müffutengi

Vörunúmer	Stærð	L	L1	Z	S
PS26270G -					
- 0150300	15 x 3/8"	54	13.5	20	19
- 0150400	15 x 1/2"	58.5	15	22.5	26
- 0150600	15 x 3/4"	61.5	16.3	24.5	31
- 0180400	18 x 1/2"	60.5	15	24.5	26
- 0180600	18 x 3/4"	61.5	16.3	24.5	31
- 0220400	22 x 1/2"	60.5	15	23.5	26
- 0220600	22 x 3/4"	62	16.3	24	31
- 0220800	22 x 1"	69.1	9.1	28	39
- 0280600	28 x 3/4"	65	16.3	25	31
- 0280800	28 x 1"	69	19.1	26	39
- 0281000	28 x 1 1/4"	75.5	21.4	30.5	48
- 0350800	35 x 1"	87.5	19.1	41.5	39
- 0351000	35 x 1 1/4"	73.5	21.4	24.5	48
- 0351200	35 x 1 1/2"	86	21.4	38	55
- 0421000	42 x 1 1/4"	92	21.4	39	48
- 0421200	42 x 1 1/2"	77	21.4	24	55
- 0541200	54 x 1 1/2"	102.5	21.4	44	55
- 0541600	54 x 2"	91.5	25.7	29	67



Slip Coupler
Samtengi langt (Skotmúffa)

Vörunúmer	Stærð	L
PS26275 0150000		
15	74	
PS26275 0180000		
18	78	
PS26275 0220000		
22	83	
PS26275 0280000		
28	92	
PS26275 0350000		
35	101	
PS26275 0420000		
42	118	
PS26275 0540000		
54	142	



Cap End
Lok

Vörunúmer	Stærð	L	L1
PS26301 0150000	15	41	20
PS26301 0180000	18	43	20
PS26301 0220000	22	44	21
PS26301 0280000	28	47.5	23
PS26301 0350000	35	51	26
PS26301 0420000	42	52.5	30
PS26301 0540000	54	62	35



3-pcs female thread union
Union-partur - múffa

Vörunúmer	Stærð	L	Z	S1	S2
PS26340G0150400	15 x 1/2"	85.5	47.5	24	26
PS26340G0150600	15 x 3/4"	89.5	52.5	30	31
PS26340G0180400	18 x 1/2"	87.5	49.5	24	26
PS26340G0220600	22 x 3/4"	88.5	51.5	30	31
PS26340G0220800	22 x 1"	95.5	54.5	36	39
PS26340G0280800	28 x 1"	99	56	36	39
PS26340G0281000	28 x 1 1/4"	101	57	46	48
PS26340G0351000	35 x 1 1/4"	105	56	46	48
PS26340G0421200	42 x 1 1/2"	120	68	52.5	55
PS26340G0541600	54 x 2"	136.5	74.5	64	67



3-pcs male thread union
Union-partur - nippill

Vörunúmer	Stærð	L	Z	S1	S2
PS26341G0150400	15 x 1/2"	91.5	71.5	24	21.5
PS26341G0150600	15 x 3/4"	94.5	74.5	30	27
PS26341G0180400	18 x 1/2"	93.5	73.5	24	21.5
PS26341G0220600	22 x 3/4"	94.5	73.5	30	27
PS26341G0220800	22 x 1"	101	80	36	34
PS26341G0280800	28 x 1"	104.5	81.5	36	34
PS26341G0281000	28 x 1 1/4"	109	86	46	43
PS26341G0351000	35 x 1 1/4"	111.5	85.5	46	43
PS26341G0421200	42 x 1 1/2"	125	95	52.5	50
PS26341G0541600	54 x 2"	141	106	64	62



Wallplate Elbow ISO -7
Vegghné

Vörunúmer	Stærð	L	L1	Z	Z1	ød	S
PS26471G -							
-0150400	15 x 1/2"	48.5	27	28.5	12	45	26
-0180400	18 x 1/2"	50.5	27	30.5	12	45	26
-0220600	22 x 3/4"	58	35	37	18	50	31



Smurefni fyrir O-hring

Vörunúmer	Magn
MPABPSOIL100ML	100 ml



Rör - ryðfrí

Vörunúmer	Gerð	Lengd	Gerð
PSTUBE-316-15 15x1.0x6M	316L	6 m	>B<
PSTUBE-316-18 18x1.0x6M	316L	6 m	>B<
PSTUBE-316-22 22x1.2x6M	316L	6 m	>B<
PSTUBE-316-28 28x1.2x6M	316L	6 m	>B<
PSTUBE-316-35 35x1.5x6M	316L	6 m	>B<
PSTUBE-316-42 42x1.5x6M	316L	6 m	>B<
PSTUBE-316-54 54x1.5x6M	316L	6 m	>B<

Leiðbeiningar fyrir uppsetning um pressfittings

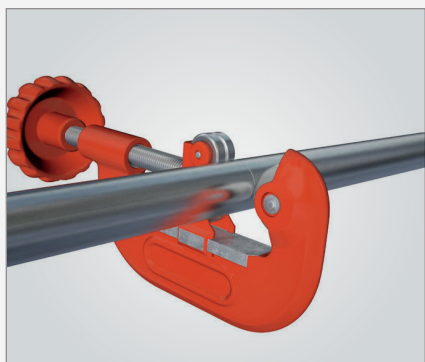

1. Skerið rörið í lengd

- Notaðu rörskera.
- Gakktu úr skugga um að rörið sé skorið rétt (90°).
- Athugaðu að rörið hafi haldið lögun sinni og ekki skemmt.

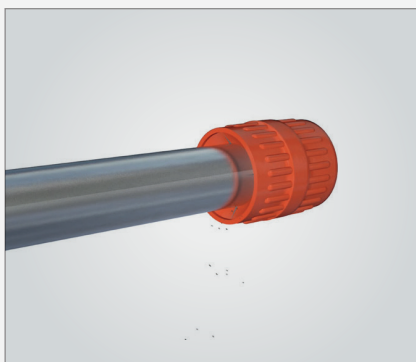

2. Ydda enda

- Yddaðu rörið bæði ytra og innra.
- Þar sem hægt er hallaðu rörinu niður til að koma í veg fyrir að kusk berist inn í rörið.
- Gakktu úr skugga um að innra og ytra yfirborð rörenda séu slétt og laus við rispur og skarpar brúnir.

Athuga:

Gakktu úr skugga um að yfirborð rörsins sé laust við djúp högg eða rispur.

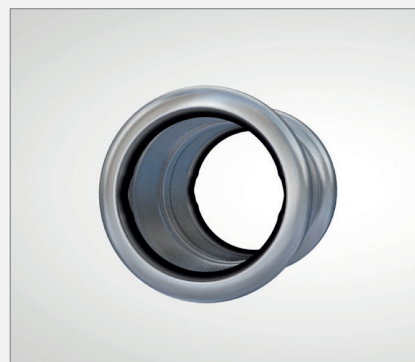

3. Skoðaðu fittingsins

- Athugaðu að fittingsin séu í réttri stærð fyrir rörið.
- Athugaðu að O-hringirnir sé á staðar réttu sæti.
- Gott er að bæta við litlu magni af Conex Bänninger pressfitting smurefni til O-hringirnir til að auðvelda samsetningu.



4. Settu saman og merktu dýptina

- Passið að rörið og fittingin verður að vera á réttum stað.
- Til að draga úr hættu á að O-hringurinn losni, snúðu rörinu (ef mögulegt er) á meðan þú setur fittingsin saman.
- Merktu dýptina á rörið.
- Áður en pressar skaltu ganga úr skugga um að rörið réttum á réttum stað.

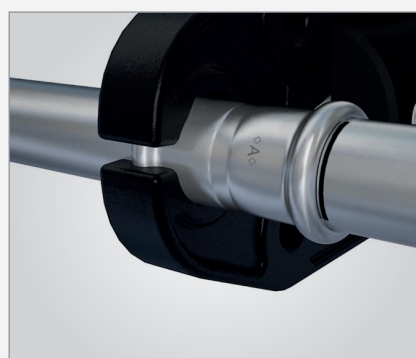

5. Klemmdu samskeytin með réttu pressutöngina.

- Athugaðu að fittingsin er rétt stilltur áður en þið pressið saman.
- Gakktu úr skugga um það ert með réttan kjálka í tönginni.
- Kjálkarnir verða að vera réttur staðsetja grópinni í miðjunni.
- Fittingsnum ætti að passa inn í miðjuna í raufinni á kjálkanum.
- Haltu inni starthnappinum á ýttu á tönginni til að ljúka pressunna.
- Pressun er lokið þegar kjálkarnir eru að lokaðir.

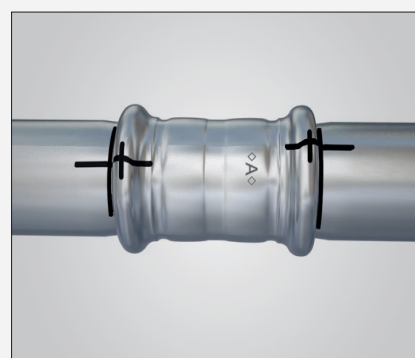

6. Klemman klár

- Merktu við samskeyti eftir pressunna
- Það verður auðveldlegara að skoða samskeyti eftir prófun.



Taktu mynd af QR kóðanum og skoðaðu nánar um leiðbeiningarnar um pressfittings í símanum.



Sjá nánar á https://loft.is/pdf/flip/L&R_Handbok_2022.pdf

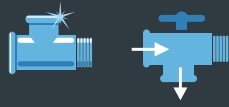

Kopar- og króm fittings

FITTINGS - LOKAR





N-Union – vinkill

Vörunúmer	Gerð	Ø stærð
6401404	N-Union – vinkill	1/2"
6401405	N-Union – vinkill	3/4"
6401406	N-Union – vinkill	1"



N-Union

Vörunúmer	Gerð	Ø stærð
6401503	N-Union	3/8"
6401504	N-Union	1/2"
6401505	N-Union	3/4"
6401506	N-Union	1"
6401507	N-Union	1 1/4"
6401508	N-Union	1 1/2"
6401509	N-Union	2"



Hné

Vörunúmer	Gerð	Ø stærð
6409003	Hné	3/8"
6409004	Hné	1/2"
6409005	Hné	3/4"
6409006	Hné	1"
6409007	Hné	1 1/4"
6409008	Hné	1 1/2"
6409009	Hné	2"



N-Hné

Vörunúmer	Gerð	Ø stærð
6409203	N-Hné	3/8"
6409204	N-Hné	1/2"
6409205	N-Hné	3/4"
6409206	N-Hné	1"
6409207	N-Hné	1 1/4"
6409208	N-Hné	1 1/2"
6409209	N-Hné	2"



Té

Vörunúmer	Gerð	Ø stærð
6413004	Té	1/2"
6413005	Té	3/4"
6413006	Té	1"
6413007	Té	1 1/4"
6413008	Té	1 1/2"
6413009	Té	2"
6413102	Té	3/4"x1/2"x3/4"
6413103	Té	1"x1/2"x1"
6413104	Té	1"x3/4"x1"



Formúffa

Vörunúmer	Gerð	Ø stærð
6420304	Formúffa	1/2"x 3/8"
6420305	Formúffa	3/4"x 3/8"
6420306	Formúffa	1"x 3/8"
6420504	Formúffa	3/4"x 1/2"
6420604	Formúffa	1"x 1/2"
6420605	Formúffa	1"x 3/4"
6420705	Formúffa	1 1/4"x 3/4"
6420706	Formúffa	1 1/4"x 1"
6420806	Formúffa	1 1/2"x 1"
6420807	Formúffa	1 1/2"x 1 1/4"
6420907	Formúffa	2"x 1 1/4"
6420908	Formúffa	2"x 1 1/2"



N-Hólkur

Vörunúmer	Gerð	Ø stærð
6430302	N-Hólkur	3/8"x 1/4"
6430402	N-Hólkur	1/2"x 1/4"
6430403	N-Hólkur	1/2"x 3/8"
6430503	N-Hólkur	3/4"x 3/8"
6430504	N-Hólkur	3/4"x 1/2"
6430603	N-Hólkur	1"x 3/8"
6430604	N-Hólkur	1"x 1/2"
6430605	N-Hólkur	1"x 3/4"
6430704	N-Hólkur	1 1/4"x 1/2"
6430705	N-Hólkur	1 1/4"x 3/4"
6430706	N-Hólkur	1 1/4"x 1"
6430804	N-Hólkur	1 1/2"x 1/2"
6430805	N-Hólkur	1 1/2"x 3/4"
6430806	N-Hólkur	1 1/2"x 1"
6430807	N-Hólkur	1 1/2"x 1 1/4"
6430904	N-Hólkur	2"x 1/2"
6430905	N-Hólkur	2"x 3/4"
6430906	N-Hólkur	2"x 1"
6430907	N-Hólkur	2"x 1 1/4"
6430908	N-Hólkur	2"x 1 1/2"
6431008	N-Hólkur	2 1/2"x 1 1/2"
6431009	N-Hólkur	2 1/2"x 2"



Brjóstnippill

Vörunúmer	Gerð	Ø stærð
6440403	Brjóstnippill	1/2"x 3/8"
6440503	Brjóstnippill	3/4"x 3/8"
6440504	Brjóstnippill	3/4"x 1/2"
6440604	Brjóstnippill	1"x 1/2"
6440605	Brjóstnippill	1"x 3/4"
6440704	Brjóstnippill	1 1/4"x 1/2"
6440705	Brjóstnippill	1 1/4"x 3/4"
6440706	Brjóstnippill	1 1/4"x 1"
6440805	Brjóstnippill	1 1/2"x 3/4"
6440806	Brjóstnippill	1 1/2"x 1"
6440807	Brjóstnippill	1 1/2"x 1 1/4"
6440906	Brjóstnippill	2"x 1"
6440907	Brjóstnippill	2"x 1 1/4"
6440908	Brjóstnippill	2"x 1 1/2"
6441009	Brjóstnippill	2 1/2"x 2"



Múffa

Vörunúmer	Gerð	Ø stærð
6457004	Múffa	1/2"
6457005	Múffa	3/4"
6457006	Múffa	1"
6457007	Múffa	1 1/4"
6457008	Múffa	1 1/2"
6457009	Múffa	2"



Frömlenging

Vörunúmer	Gerð	Ø stærð
6463010	Frömlenging	2 1/2"
6470203	Frömlenging	3/8" x 1cm
6470204	Frömlenging	1/2" x 1cm
6470206	Frömlenging	1" x 1cm
6470304	Frömlenging	1/2" x 1,5cm
6470306	Frömlenging	1" x 1,5cm
6470403	Frömlenging	3/8" x 2cm
6470404	Frömlenging	1/2" x 2cm
6470406	Frömlenging	1" x 2cm
6470503	Frömlenging	3/8" x 2,5cm
6470504	Frömlenging	1/2" x 2,5cm
6470506	Frömlenging	1" x 2,5cm
6470604	Frömlenging	1/2" x 3cm
6470606	Frömlenging	1" x 3cm
6470703	Frömlenging	3/8" x 4cm
6470704	Frömlenging	1/2" x 4cm
6470803	Frömlenging	3/8" x 5cm
6470804	Frömlenging	1/2" x 5cm
6470904	Frömlenging	1/2" x 6,5cm
6471003	Frömlenging	3/8" x 8cm
6471004	Frömlenging	1/2" x 8cm
6471103	Frömlenging	3/8" x 10cm
6471104	Frömlenging	1/2" x 10cm



N-Formúffa

Vörunúmer	Gerð	Ø stærð
6480304	N-Formúffa	1/2"x3/8"
6480403	N-Formúffa	3/8"x 1/2"
6480405	N-Formúffa	3/4"x 1/2"
6480503	N-Formúffa	3/8"x 3/4"
6480506	N-Formúffa	3/4"x 1"
6480604	N-Formúffa	1/2"x 1"
6480605	N-Formúffa	1"x 3/4"
6480705	N-Formúffa	3/4"x 1 1/4"
6480706	N-Formúffa	1"x 1 1/4"
6680504	N-Formúffa	1/2"x 3/4"



Botnlok

Vörunúmer	Gerð	Ø stærð
6463004	Botnlok	1/2"
6463005	Botnlok	3/4"
6463006	Botnlok	1"
6463007	Botnlok	1 1/4"
6463008	Botnlok	1 1/2"
6463009	Botnlok	2"



Brjóstnippill

Vörunúmer	Gerð	Ø stærð
6458003	Brjóstnippill	3/8"
6458004	Brjóstnippill	1/2"
6458005	Brjóstnippill	3/4"
6458006	Brjóstnippill	1"
6458007	Brjóstnippill	1 1/4"
6458008	Brjóstnippill	1 1/2"
6458009	Brjóstnippill	2"
6458010	Brjóstnippill	2 1/2"



Tappi

Vörunúmer	Gerð	Ø stærð
6459003	Tappi	3/8"
6459004	Tappi	1/2"
6459005	Tappi	3/4"
6459006	Tappi	1"
6459007	Tappi	1 1/4"
6459008	Tappi	1 1/2"
6459009	Tappi	2"



Rörbútur 70

Vörunúmer	Lengd	Ø stærð
6510401	4 cm	1/2"
6510402	5 cm	1/2"
6510403	6 cm	1/2"
6510404	8 cm	1/2"
6510405	10 cm	1/2"
6510407	15 cm	1/2"
6510408	20 cm	1/2"
6510501	4 cm	3/4"
6510502	5 cm	3/4"
6510503	6 cm	3/4"
6510504	8 cm	3/4"
6510505	10 cm	3/4"
6510506	12 cm	3/4"
6510603	6 cm	1"
6510604	8 cm	1"
6510605	10 cm	1"
6510606	12 cm	1"
6510703	6 cm	1 1/4"
6510704	8 cm	1 1/4"
6510705	10 cm	1 1/4"
6510805	10 cm	1 1/2"
6510807	15 cm	1 1/2"
6510905	10 cm	2"



Unionpartur

Vörunúmer	Gerð	Ø stær
6520405	Unionpartur	3/4" x 1/2"
6520506	Unionpartur	1" x 3/4"
6520708	Unionpartur	1 1/2" x 1 1/4"
6620607	Unionpartur	1 1/4" x 1"



N-Té

Vörunúmer	Gerð	Ø stærð
6813404	NMM	1/2"
6813405	NMM	3/4"
6813604	NNM	1/2"
6813605	NNM	3/4"
6813704	MNM	1/2"
6813705	MNM	3/4"



Einstreymisloki – HEXA

Vörunúmer	Gerð	Ø strö
2301G403	PN25	3/8"
2301G404	PN25	1/2"
2301G405	PN25	3/4"
2301G406	PN25	1"
2301G407	PN18	1 1/4"
2301G408	PN18	1 1/2"
2301G409	PN18	2"



Vegghné 133

Vörunúmer	Gerð	Ø stærð
6491004	Vegghné	1/2"

HRAÐTENGI



Samtengi - Hraðtengi

Vörunúmer	Gerð	stærð mm
01010005	F/PE Rör - N-tengi	25x3/4"



M-tengi - Hraðtengi

Vörunúmer	Gerð	stærð
01020005P	F/PE Rör - M-tengi	25x3/4"



Hné - Hraðtengi

Vörunúmer	Gerð	stærð mm
01080005P	F/PE Rör - Hné	25 mm



Samtengi - Hraðtengi

Vörunúmer	Gerð	stærð mm
01030005	F/PE Rör - Samtengi	25 mm



Té - Hraðtengi

Vörunúmer	Gerð	stærð mm
01050005	F/PE Rör - Té	25 mm



Loki - Hraðtengi

Vörunúmer	Gerð	stærð
4E02N965P	Loki m/hraðtengi f/PEH	25 mm



Innsert - Hraðtengi

Vörunúmer	Gerð	stærð mm
09120005	Innsert í rör	25 mm

KRÓM



Veggné - Króm

Vörunúmer	Gerð	Ø stærð
06491004C	Veggné	1/2"



Hné - Króm

Vörunúmer	Gerð	Ø stærð
06409003C	Hné	3/8"
06409004C	Hné	1/2"



N-Hné - Króm

Vörunúmer	Gerð	Ø stærð
06409203C	N-Hné	3/8"
06409204C	N-Hné	1/2"



Té - Króm

Vörunúmer	Gerð	Ø stærð
06413003C	Té	3/8"
06413004C	Té	1/2"

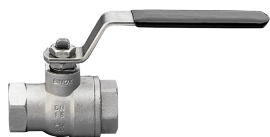

**Kúluloki –
ALBA AISI 316**

Vörunúmer	Gerð	Ø stærð
2601X204	A316 PN64	1/2"
2601X204	A316 PN64	1/2"
2601X205	A316 PN64	3/4"
2601X206	A316 PN64	1"
2601X207	A316 PN40	1 1/4"
2601X208	A316 PN40	1 1/2"
2601X209	A316 PN40	2"



**Kúluloki –
GEMINI**

Vörunúmer	Gerð	Ø stærð
2841X204	T bor 3áttir A316	1/2"
2841X205	T bor 3áttir A316	3/4"
2841X206	T bor 3áttir A316	1"
2841X207	T bor 3áttir A316	1 1/4"
2841X208	T bor 3áttir A316	1 1/2"



**Kúluloki –
DELTA**

Vörunúmer	Gerð	Ø stærð
1150N205	3áttir PN10	3/4"
1150N206	3áttir PN10	1"



**Kúluloki –
AIRY**

Vörunúmer	Gerð	Ø stærð
2351N202	MM PN12	1/4"
2351N203	MM PN12	3/8"
2351N204	MM PN12	1/2"
2351N205	MM PN12	3/4"
2351N206	MM PN12	1"
2351N207	MM PN12	1 1/4"
2351N208	MM PN12	1 1/2"
2351N209	MM PN12	2"



Kúluloki – GALAXI

Vörunúmer	Gerð	Ø strö
0504V204	MM PN50	1/2"
0504V205	MM PN50	3/4"
0504V206	MM PN40	1"
0504V207	MM PN40	1 1/4"
0504V208	MM PN40	1 1/2"
0504V209	MM PN40	2"
0505V263	MN PN50	3/8"
0505V264	MN PN50	1/2"
0505V265	MN PN50	3/4"
0505V266	MN PN40	1"
0505V267	MN PN40	1 1/4"
0505V268	MN PN40	1 1/2"
0505V269	MN PN40	2"
0524V203	MM PN50 T-hand	3/8"
0524V204	MM PN50 T-hand	1/2"
0524V205	MM PN50 T-hand	3/4"
0524V206	MN PN40 T-handf kop	1"
0525V264	MN PN50 T-hand	1/2"
0525V265	MN PN50 T-hand	3/4"



Kúluloki – ASTER

Vörunúmer	Gerð	Ø strö
0812R410	MN PN40	2 1/2"
0814R404	MM PN40	1/2"
0814R405	MM PN40	3/4"
0814R406	MM PN40	1"
0814R407	MM PN40	1 1/4"
0814R408	MM PN40	1 1/2"
0814R409	MM PN40	2"
0814R410	MM PN40	2 1/2"
0814R411	MM PN40	3"
0814R412	MM PN40	4"
0815R404	MN PN40	1/2"
0815R405	MN PN40	3/4"
0815R406	MN PN40	1"
0815R407	MN PN40	1 1/4"
0815R408	MN PN40	1 1/2"
0815R409	MN PN40	2"
0824R402	MM PN40 T-hand	1/4"
0824R403	MM PN40 T-hand	3/8"
0824R404	MM PN40 T-hand kop	1/2"
0824R405	MM PN40 T-hand	3/4"
0824R406	MM PN40 T-handf kop	1"
0825R402	MN PN40 T-hand	1/4"
0825R403	MN PN40 T-hand	3/8"
0825R404	MN PN40 T-hand kop	1/2"
0825R405	MN PN40 T-hand	3/4"
0825R406	MN PN40 T-handf	1"



Kúluloki – VEGA

Vörunúmer	Gerð	Ø strö
V4605210	A316 PN 140	2 1/2"
V4605211	A316 PN 140	3"
V4606207	A316 PN 100	1 1/4"
V4606208	A316 PN 100	1 1/2"
V4606209	A316 PN 100	2"
V4608204	A316 PN 140	1/2"



Kúluloki – LYBRA

Vörunúmer	Gerð	Ø strö
1801N204	PN 40	1/2"
1801N205	PN 40	3/4"
1801N206	PN 40	1"
1801N207	PN 40	1 1/4"
1801N208	PN 40	1 1/2"
1801N209	PN 40	2"



Kúluloki – Mini

Vörunúmer	Gerð	Ø strö
1501C401	MM PN10	1/8"
1501C402	MM PN10	1/4"
1501C403	MM PN10	3/8"
1501C404	MM PN10	1/2"
1502C401	MN PN10	1/8"
1502C402	MN PN10	1/4"
1502C403	MN PN10	3/8"
1502C404	MN PN10	1/2"

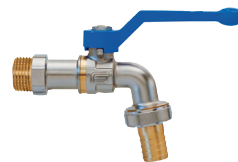

Slöngukrani – VIVA

Vörunúmer	Gerð	Ø strö
1730B404	PN10	1/2"
1730B405	PN10	3/4"



LOKAR

HITASTÝRINGU - BLÖNDUNARLOKAR - STJÓRNLOKAR



MIKILL ORKUSPARNAÐUR - Þegar blanda þarf vökva og fá út rétt hitastig er lausnin



Hitastýring - úti og inni hitastig

Sería CRD100

Viraður hiastillir - nemi fyrir framrás

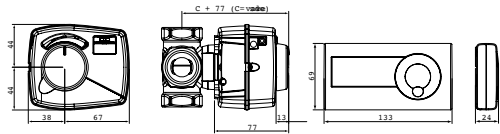

Númer	Tivísun	Spenna [V AC]	Tog [Nm]	Mælir í herbergi	Þyngd [kg]
12682200	CRD122	230	6	Þráðlaust	1,2



Hitastýring - inni

Sería CRB100

Þráðlaust hitastillir - nemi fyrir framrás

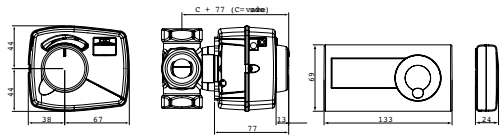

Númer	Tivísun	Spenna [V AC]	Tog [Nm]	Mælir í herbergi	Athugun	Kemur í staðinn
12662200	CRB122	230	6	Þráðlaust		12662100



Hitastýring með veðurstöð fyrir ofnakerfi/gólfhita

Sería CRC110

Útinemi - nemi fyrir framrás

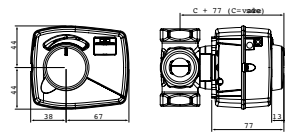

Númer	Tivísun	Spenna [V AC]	Tog [Nm]	Athugun
12820100	CRC111	230	6	



Hitastýring

Sería CRS130

Stöðugt hitastig fyrir neysluvatn

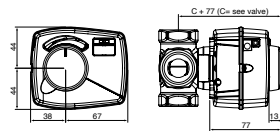

Númer	Tivísun	Spenna [V AC]	Hitastig	Tog [Nm]	Tenging A	Þyngd [kg]
12723100	CRS131	230	5-95°C	6	R 1/2"	0,7

ÁREIÐANLEGT OG AUÐVELT Í MEÐHÖNDLUN

VRG130 kerfið eru þríhlíða lokar sem henta til að blanda eða beina notkun. Lokarnir eru gerðir úr sterkum kopar sem gerir kleift að nota í upphitunar- og kælikerfi. VRG kerfið er fánlegt í DN15-50 og því fylgja mismunandi gerðir tenginga sem henta flestum rörum.

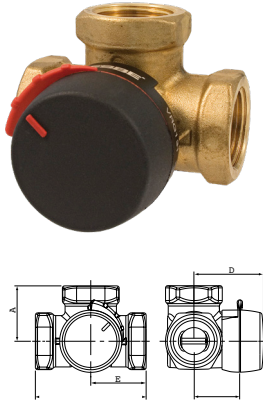

Blöndunarlokar

Sería VRG131 - Inngengur

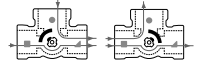

Númer	Tivisun	DN	*Kvs	Tenging	A [mm]	B [mm]	C [mm]	D [mm]	E [mm]	Þyngd [kg]	Kemur í staðinn
11600100	VRG131	15	0,4	Rp ½"	36	72	32	50	36	0,40	
11600200	VRG131	15	0,63	Rp ½"	36	72	32	50	36	0,40	11000200
11600300	VRG131	15	1	Rp ½"	36	72	32	50	36	0,40	11000300
11600400	VRG131	15	1,6	Rp ½"	36	72	32	50	36	0,40	11000400, 11000500
11600500	VRG131	15	2,5	Rp ½"	36	72	32	50	36	0,40	11000100
11600600	VRG131	15	4	Rp ½"	36	72	32	50	36	0,40	
11600700	VRG131	20	2,5	Rp ¾"	36	72	32	50	36	0,43	
11600800	VRG131	20	4	Rp ¾"	36	72	32	50	36	0,43	11000700
11600900	VRG131	20	6,3	Rp ¾"	36	72	32	50	36	0,43	11001100, 11050100
11601000	VRG131	25	6,3	Rp 1"	41	82	34	52	41	0,70	11001600
11601100	VRG131	25	10	Rp 1"	41	82	34	52	41	0,70	11002400, 11050200
11601200	VRG131	32	16	Rp 1½"	47	94	37	55	47	0,95	11002700, 11050300
11603400	VRG131	40	25	Rp 1½"	53	106	44	62	53	1,68	11050400, 11601300
11603600	VRG131	50	40	Rp 2"	60	120	46	64	60	2,30	11050600, 11601400

*Kvs = m³/h



Blöndunarlokar

Sería VRG132 - Útgengur

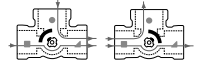

Númer	Tivisun	DN	*Kvs	Tenging	A [mm]	B [mm]	C [mm]	D [mm]	E [mm]	Þyngd [kg]	Kemur í staðinn
11601500	VRG132	15	0,4	G ¾"	36	72	32	50	36	0,40	
11601600	VRG132	15	0,63	G ¾"	36	72	32	50	36	0,40	
11601700	VRG132	15	1	G ¾"	36	72	32	50	36	0,40	
11601800	VRG132	15	1,6	G ¾"	36	72	32	50	36	0,40	
11601900	VRG132	15	2,5	G ¾"	36	72	32	50	36	0,40	
11602000	VRG132	15	4	G ¾"	36	72	32	50	36	0,40	
11602100	VRG132	20	2,5	G 1"	36	72	32	50	36	0,43	
11602200	VRG132	20	4	G 1"	36	72	32	50	36	0,43	
11602300	VRG132	20	6,3	G 1"	36	72	32	50	36	0,43	11001300
11602400	VRG132	25	6,3	G 1½"	41	82	34	52	41	0,70	
11602500	VRG132	25	10	G 1½"	41	82	34	52	41	0,70	11002600
11602600	VRG132	32	16	G 1½"	47	94	37	55	47	0,95	11002900
11603500	VRG132	40	25	G 2"	53	106	44	62	53	1,69	11602700
11603700	VRG132	50	40	G 2½"	60	120	46	64	60	2,30	11602800

*Kvs = m³/h



Unionpartur

Sería KTD100

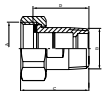

Númer	Tivisun	Tenging A	Tenging B	C [mm]	D [mm]	Þyngd [kg]
36551700	KTD112	G 1"	R ¾"	43	35	0,36
36551800	KTD112	G 1½"	R 1"	48,5	40	0,63
36551900	KTD112	G 1½"	R 1½"	55,5	45	0,97
36552000	KTD112	G 2"	R 1½"	62	50	1,32
36552100	KTD112	G 2½"	R 2"	68	55	2,18



Unionpartur með einstefnuloka

Sería KTD200, KTD300

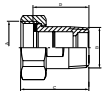

Númer	Tivisun	Tenging A	Tenging B	C [mm]	D [mm]	Þyngd [kg]
36552200	KTD212	G 1"	R ¾"	43	35	0,36
36552400	KTD312	G 1"	R ¾"	43	35	0,36
36552300	KTD212	G 1½"	R 1"	48,5	40	0,63
36552500	KTD312	G 1½"	R 1"	48,5	40	0,63

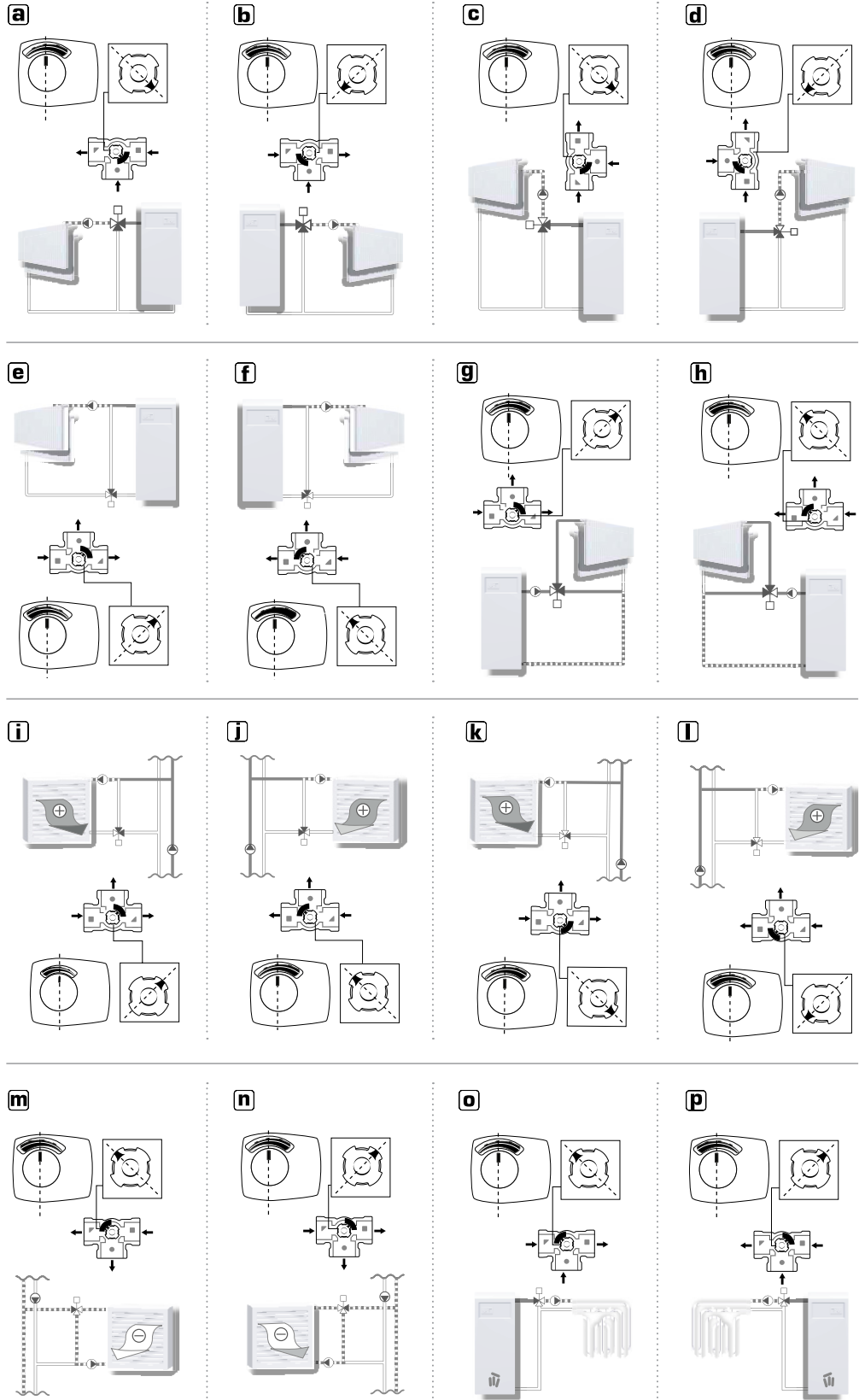

STJÓRNLOKAR FYRIR BLÁSARA OG LOFTRÆSTINGAR



Stýringar

Sería ALG400

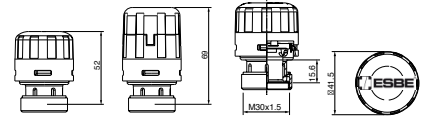

Númer	Tivisun	Spenna	Control signal	Force [N]	Stroke [mm]	Running time [s]
22500100	ALG434	110–230V AC	2-point	140	2.5	see table
22500200	ALG436	224V AC/DC	2-point	140	2.5	see table
22500300	ALG438	24V AC	Proportional	140	2.5	see table



Hítaloki

VL122 - Tvær áttir

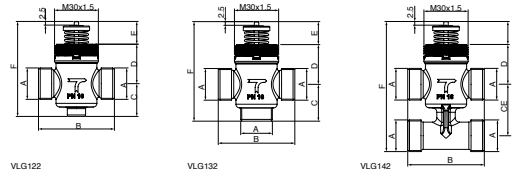

Númer	Tivisun	DN	Kvs*	A	B	C	D	E	F	Þyngd [kg]
	VL122	15	0,25	G ½"	52	23	27	16	65	0,12
21500200	VL122	15	0,4	G ½"	52	23	27	16	65	0,12
21500300	VL122	15	0,6	G ½"	52	23	27	16	65	0,12
21500400	VL122	15	1	G ½"	52	23	27	16	65	0,12
21500500	VL122	15	1,6	G ½"	52	23	27	16	65	0,12
21500600	VL122	20	2,5	G ¾"	56	24	26	16	65	0,15
21500700	VL122	20	4	G ¾"	78	21	41	16	77	0,38
21500800	VL122	20	6	G ¾"	78	21	41	16	77	0,36



VL132 - Þrjár áttir

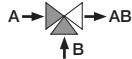

Númer	Tivisun	DN	Kvs* A	Kvs* B	ΔP	A	B	C	D	E	F	Þyngd [kg]
21501100	VL132	15	0,25	0,25	4	G ½"	52	25	27	16	65	0,13
21501200	VL132	15	0,4	0,4	4	G ½"	52	25	27	16	65	0,13
21501300	VL132	15	0,6	0,6	4	G ½"	52	25	27	16	65	0,13
21501400	VL132	15	1	0,6	3,5	G ½"	52	25	27	16	65	0,13
21501500	VL132	15	1,6	1	3,5	G ½"	52	25	27	16	65	0,13
21501600	VL132	20	2,5	1,6	3,5	G ¾"	56	34	26	16	75	0,17
21501700	VL132	20	4	2,5	1(0,4)	G ¾"	78	36	41	16	92	0,41
21501800	VL132	20	6	4	1(0,4)	G ¾"	78	36	41	16	92	0,40



VL142 - Þrjár áttir með hjáleið

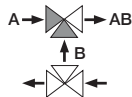

Númer	Tivisun	DN	Kvs* A	Kvs* B	ΔP	A	B	C	D	E	F	Þyngd [kg]
21502100	VL142	15	0,25	0,25	4	G ½"	52	35	27	16	88	0,20
21502200	VL142	15	0,4	0,4	4	G ½"	52	35	27	16	88	0,20
21502300	VL142	15	0,6	0,6	4	G ½"	52	35	27	16	88	0,20
21502400	VL142	15	1	0,6	3,5	G ½"	52	35	27	16	88	0,20
21502500	VL142	15	1,6	1	3,5	G ½"	52	35	27	16	88	0,20
21502600	VL142	20	2,5	1,6	3,5	G ¾"	56	50	26	16	98	0,27
21502700	VL142	20	4	2,5	1(0,4)	G ¾"	78	44	41	16	114	0,52
21502800	VL142	20	6	4	1(0,4)	G ¾"	78	44	41	16	114	0,51

*Kvs = m³/h

Dæmi um uppsetningu:

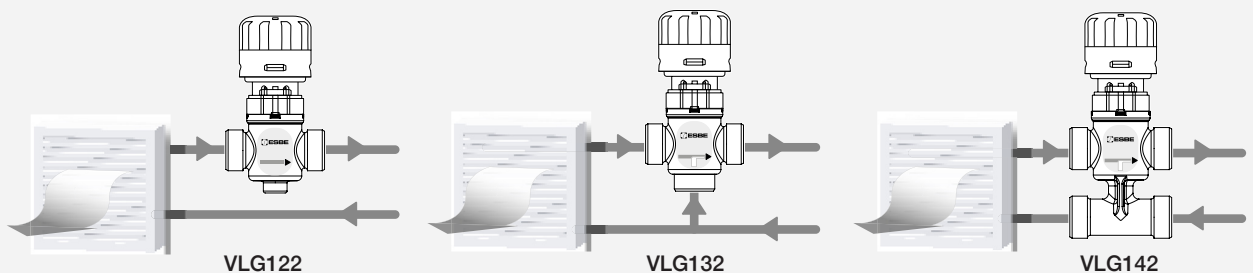

LEIÐBEININGAR FYRIR HITASTÝRINGAR OG BLÖNDUNARLOKA

● Mælt með

● Annar valkostur

	Stjórnartæki						Stjórnun			
	ARA6xx		90			90C	CRA11x, CRA14x CRA15x	CRB11x CRB12x	CRA12x	CRS13x
	3-P	2-P	Prop.	3-P	2-P		Prop.	CRC11x CRC14xC	RD12x	
 VRG130										
 VRG330	●	●	●	●*	●*	●*	●	●	●*	●
 VRH130										
 VRG140	●	●	●	●*	●*	●*	●	●	●*	●
 VRG230	●	●	●	●*	●*	●*	●	●	●*	●
 VRB140	●		●	●*		●*	●		●*	●
 5MG				●**		●**				
 3HG, 4HG	●	●	●				●	●		

ATH: *Aukabúnaður fyrir millistykki nauðsynlegur. ** Aðeins fyrir gerð 95-270M og 92P4



Sería VTA321

Númer	Tivisun	Hiti °C	Kvs [l/min]	Tenging	A [mm]	B [mm]	C [mm]	D [mm]	Þyngd [kg]
31100300	VTA321	20 - 43	1,5 - 24	Rp ½"	70	42	52	46	0,45
31100700	VTA321	20 - 43	1,6 - 26	Rp ¾"	70	42	52	46	0,48
31100400	VTA321	35 - 60	1,5 - 24	Rp ½"	70	42	52	46	0,45
31100800	VTA321	35 - 60	1,6 - 26	Rp ¾"	70	42	52	46	0,48



Sería VTA322 / VTA522

Númer	Tivisun	Hiti °C	Kvs [l/min]	Tenging	A [mm]	B [mm]	C [mm]	D [mm]	Þyngd [kg]
31102800	VTA322	20 - 43	1,2 - 20	G ½"	70	42	52	46	0,41
31100500	VTA322	20 - 43	1,5 - 24	G ¾"	70	42	52	46	0,45
31100900	VTA322	20 - 43	1,6 - 26	G 1"	70	42	52	46	0,48
31620100	VTA522	20 - 43	3,2 - 54	G 1"	84	62	60	56	0,86
31620400	VTA522	20 - 43	3,5 - 57	G 1½"	84	62	60	56	0,95
31103200	VTA322	30 - 70	1,6 - 26	G 1"	70	42	52	46	0,53
31102900	VTA322	35 - 60	1,2 - 20	G ½"	70	42	52	46	0,41
31100600	VTA322	35 - 60	1,5 - 24	G ¾"	70	42	52	46	0,45
31101000	VTA322	35 - 60	1,6 - 26	G 1"	70	42	52	46	0,48
31104700	VTA322	45 - 65	1,6 - 26	G 1"	70	42	52	46	0,55
31620200	VTA522	45 - 65	3,2 - 54	G 1"	84	62	60	56	0,86
31620500	VTA522	45 - 65	3,5 - 27	G 1¼"	84	62	60	56	0,95
31620300	VTA522	50 - 75	3,2 - 54	G 1"	84	62	60	56	0,86
31620600	VTA522	50 - 75	3,5 - 27	G 1¼"	84	62	60	56	0,95



Sería VTA323

Númer	Tivisun	Hiti °C	Kvs [l/min]	Tenging	A [mm]	B [mm]	C [mm]	D [mm]	Þyngd [kg]
31102600	VTA323	20 - 43	1,2 - 20	CPF 15 mm	86	50	52	46	0,49
31100100	VTA323	20 - 43	1,5 - 24	CPF 22 mm	86	50	52	46	0,57
31102700	VTA323	35 - 60	1,2 - 20	CPF 15 mm	86	50	52	46	0,49
31103900	VTA323	35 - 60	1,5 - 24	CPF 18 mm	86	50	52	46	0,66
31100200	VTA323	35 - 60	1,5 - 24	CPF 22 mm	86	50	52	46	0,57



Sería VTA332

Númer	Tivisun	Hiti °C	Kvs [l/min]	Tenging	A [mm]	B [mm]	C [mm]	D [mm]	Þyngd [kg]
31150200	VTA332	32 - 49	1,2 - 20	G ¾"	70	54	52	46	0,52
31150700	VTA332	35 - 60	1,2 - 20	G ¾"	70	54	52	46	0,52
31150900	VTA332	35 - 60	1,3 - 22	G 1"	70	54	52	46	0,55



Sería VTA377

Númer	Tivisun	Hiti °C	Kvs [l/min]	Tenging	Tenging	A [mm]	B [mm]	C [mm]	D [mm]	Þyngd [kg]
31200200	VTA377	20 - 55	3,4 - 56	G 1"	PF 1½"	86	42	52	56	0,58
31702300	VTA577	20 - 55	4,5 - 70	G 1"	PF 1½"	100	62	60	56	0,99



Sería VTA522

Númer	Tivisun	Hiti °C	Kvs [l/min]	Tenging	A [mm]	B [mm]	C [mm]	D [mm]	Þyngd [kg]
31620700	VTA522	20 - 43	3,0 - 52	R ¾"	154	97	60	56	1,22
31621000	VTA522	20 - 43	3,4 - 56	R 1"	164	102	60	56	1,59
31621600	VTA523	20 - 43	3,4 - 56	CPF 28 mm	204	122	60	56	1,90
31620800	VTA522	45 - 65	3,0 - 52	R ¾"	154	97	60	56	1,22
31621400	VTA523	45 - 65	3,0 - 52	CPF 22 mm	180	110	60	56	1,42
31621100	VTA522	45 - 65	3,4 - 56	R 1"	164	102	60	56	1,59
31621700	VTA523	45 - 65	3,4 - 56	CPF 28 mm	204	122	60	56	1,90
31620900	VTA522	50 - 75	3,0 - 52	R ¾"	154	97	60	56	1,22
31621200	VTA522	50 - 75	3,4 - 56	R 1"	164	102	60	56	1,59



Númer	Tivisun	Hiti °C	Kvs [l/min]	Tenging	A [mm]	B [mm]	C [mm]	D [mm]	Þyngd [kg]
31660100	VTA552	20 - 43	3,2	G 1"	84	50	60	56	0,78
31660400	VTA552	20 - 43	3,5	G 1½"	84	50	60	56	0,87
31105000	VTA352	35 - 60	1,5	G ¾"	70	42	52	46	0,45
31105100	VTA352	35 - 60	1,6	G 1"	70	42	52	46	0,48
31660200	VTA552	45 - 65	3,2	G 1"	84	50	60	56	0,78
31660500	VTA552	45 - 65	3,5	G 1¼"	84	50	60	56	0,87
31660300	VTA552	50 - 75	3,2	G 1"	84	50	60	56	0,78
31660600	VTA552	50 - 75	3,5	G 1¼"	84	50	60	56	0,87



Seria VTA352

Númer	Tivisun	Hiti °C	Kvs [l/min]	Tenging	A [mm]	B [mm]	C [mm]	D [mm]	F [mm]	Þyngd [kg]
31106100	VTA352	35 - 60	1,5 - 24	G 1"	70	42	52	46	74	0,48

Númer	Tivisun	Hiti °C	Kvs [l/min]	Tenging	A [mm]	B [mm]	C [mm]	D [mm]	Þyngd [kg]
31105000	VTA352	35 - 60	1,5 - 24	G ¾"	70	42	52	46	0,45



Seria VTA362

Númer	Tivisun	Hiti °C	Kvs [l/min]	Tenging	A [mm]	B [mm]	C [mm]	D [mm]	Þyngd [kg]
31151400	VTA362	32 - 49	1,2 - 20	G ¾"	70	42	52	46	0,45
31151100	VTA362	35 - 60	1,2 - 20	G ¾"	70	42	52	46	0,45
31151200	VTA362	35 - 60	1,3 - 22	G 1"	70	42	52	46	0,48



Seria VTA572

Númer	Tivisun	Hiti °C	Kvs [l/min]	Tenging	A [mm]	B [mm]	C [mm]	D [mm]	Þyngd [kg]
31700100	VTA572	10 - 30	4,5 - 70	G 1"	84	62	60	56	0,86
31700400	VTA572	10 - 30	4,8 - 72	G 1¼"	84	62	60	56	0,95
31200100	VTA372	20 - 55	3,4 - 56	G 1"	70	42	52	46	0,44
31702100	VTA572	20 - 55	4,5 - 70	G 1"	84	62	60	56	0,86
31702200	VTA572	20 - 55	4,8 - 72	G 1¼"	84	62	60	56	0,95
31200400	VTA372	30 - 70	3,4 - 56	G 1"	70	42	52	46	0,48
31702500	VTA572	30 - 70	4,5 - 70	G 1"	84	62	60	56	0,86
31702600	VTA572	30 - 70	4,8 - 72	G 1¼"	84	62	60	56	0,95



Rafmagnsrótor -

Vörunúmer	Stjarna / Lengs á milli róa	Tog	Spenna	Kraftur	tími án álags	tími álags
ER20.X03.M00	14/F03-F04-F05	20Nm	24V 50/60Hz (24V DC)	15W	7s	12s
ER20.X0A.M00	14/F03-F04-F05	20Nm	100V to 240V 50/60Hz (100V to 350V DC)	15W	9s	13s
ER20.X3B.GP6	14/F03-F04-F05	20Nm,	15-30VAC/12-48VDC	15W,		25s
ER20.X0A.GF3	14/F03-F04-F05	20Nm	100V - 240V 50/60Hz (100V - 350V DC)	15W	9s	12s
ER20.X3A.GP6	14/F03-F04-F05	20Nm	100-240VAC/100-350VDC	15W,		25s
ER20.X3A.GP6	14/F03-F04-F05	20Nm	100-240VAC/100-350VDC	15W,		25s
ER20.X3A.GP6.U/3020	14 F03/F04/F05	20 Nm	100 V to 240 V 50/60 Hz (100 V to 350 V DC)	15 W	25 s	
ER20.X3A.GP6.U/3020			230v 20Nm Posi Card P6 180°			

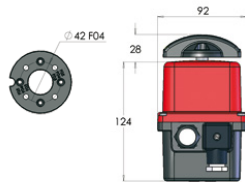

Rafmagnsrótor -

Vörunúmer	Stjarna / Lengs á milli róa	Tog	Spenna	Kraftur	tími án álags	tími álags
ER35.90A.M00	22/F05-F07	35Nm	100V to 240V 50/60Hz (100V to 350V DC)	45W	7s	8s
ER35.903.M00	22/F05-F07	35Nm	24V 50/60Hz (24V DC)	45W	6s	7s
ER35.93A.GP6	22/F05-F07	35Nm	100V to 240V 50/60Hz (100V to 350V DC)	45W	34s	40s
ER35.93B.GP6	22/F05-F07	60Nm	100V to 240V 50/60Hz (100V to 350V DC)	45W	67s	79s

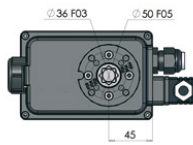

Rafmagnsrótor -

Vörunúmer	Stjarna / Lengs á milli róa	Tog	Spenna	Kraftur	tími án álags	tími álags
ER60.90A.M00	22/F05/F07	60Nm	100 V to 240 V 50/60 Hz (100 V to 350 V DC)	45 W	7s	15 s
ER60.90A.G00	22/F05-F07	60Nm	100V to 240V 50/60Hz (100V to 350V DC)	45W	10s	12s
ER60.93A.GP6	22 / F05-F07	60Nm	100V to 240V 50/60Hz (100V to 350V DC)	45W	67s	79s
ER60.93B.GP6	22 / F05-F07	60Nm	15V to 30V 50/60Hz (12V to 48V DC)	45W	68s 7	9s

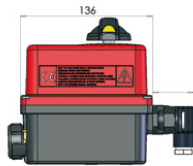

Rafmagnsrótor -

Vörunúmer	Stjarna / Lengs á milli róa	Tog	Spenna	Kraftur	tími án álags	tími álags
ER100.90A.M00	22/F05-F07	100Nm	100V to 240V 50/60Hz (100V to 350V DC)	45W	22s	25s
ER100.903.M00	22/F05-F07	100Nm	24V 50/60Hz (24V DC)	45W	18s	22s
ER100.93A.GP6	22 F05/F07	100 Nm	100 V to 240 V 50/60 Hz (100 V to 350 V DC)	45 W	119 s	
ER100.93B.GP6/3020	22 F05/F07	100 Nm	100 V to 240 V 50/60 Hz (100 V to 350 V DC)	45 W	119 s	



Rafmagnsrótor - STANDARD RANGE

Vörunúmer	Stjarna / Lengd á milli róa	Tog	Spenna	Kraftur	tími án álags	tími án álags
ER20.X0A.G00**	14/F03-F04-F05	20Nm	100V - 240V 50/60Hz (100V - 350V DC)	15W	9s	12s
ER20.X0B.G00**	14/F03-F04-F05	20Nm	15V - 30V 50/60Hz (12V - 48V DC)	15W	9s	12s
ER35.X0A.G00**	14/F03-F04-F05	35Nm	100V - 240V 50/60Hz (100V - 350V DC)	15W	19s	26s
ER35.X0B.G00**	14/F03-F04-F05	35Nm	15V - 30V 50/60Hz (12V - 48V DC)	15W	19s	24s
ER35.90A.G00	22/F05-F07	35Nm	100V - 240V 50/60Hz (100V - 350V DC)	45W	6s	7s
ER35.90B.G00	22/F05-F07	35Nm	15V - 30V 50/60Hz (12V - 48V DC)	45W	6s	7s
ER60.90A.G00	22/F05-F07	60Nm	100V - 240V 50/60Hz (100V - 350V DC)	45W	10s	12s
ER60.90B.G00	22/F05-F07	60Nm	15V - 30V 50/60Hz (12V - 48V DC)	45W	10s	12s
ER100.90A.G00	22/F05-F07	100Nm	100V - 240V 50/60Hz (100V - 350V DC)	45W	20s	23s
ER100.90B.G00	22/F05-F07	100Nm	15V - 30V 50/60Hz (12V - 48V DC)	45W	19s	22s

Rafmagnsrótor - LONG OPERATING TIME RANGE

Vörunúmer	Stjarna / Lengd á milli róa	Tog	Spenna	Kraftur	tími án álags	tími án álags
ER35.93A.G00	22/F05-F07	35Nm	100V - 240V 50/60Hz (100V - 350V DC)	45W	34s	40s
ER35.93B.G00	22/F05-F07	35Nm	15V - 30V 50/60Hz (12V - 48V DC)	45W	34s	41s
ER60.93A.G00	22/F05-F07	60Nm	100V - 240V 50/60Hz (100V - 350V DC)	45W	67s	79s
ER60.93B.G00	22/F05-F07	60Nm 1	15V - 30V 50/60Hz (12V - 48V DC)	45W	68s	79s
ER100.93A.G00	22/F05-F07	100Nm	100V - 240V 50/60Hz (100V - 350V DC)	45W	110s	119s
ER100.93B.G00	22/F05-F07	100Nm	15V - 30V 50/60Hz (12V - 48V DC)	45W	110s	119s

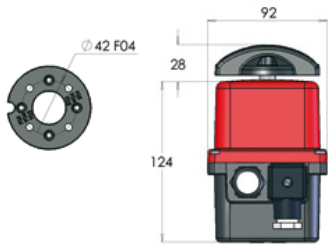

Rafmagnsrótor - STANDARD RANGE

Vörunúmer	Stjarna / Lengd á milli róa	Tog	Spenna	Kraftur	tími án álags	tími án álags
ER10.X0A.GF3**	14/F03-F04-F05	10Nm	100V - 240V 50/60Hz (100V - 350V DC)	15W	9s	11s
ER10.X0B.GF3**	14/F03-F04-F05	10Nm	15V - 30V 50/60Hz (12V - 48V DC)	15W	9s	11s
ER20.X0A.GF3**	14/F03-F04-F05	20Nm	100V - 240V 50/60Hz (100V - 350V DC)	15W	9s	12s
ER20.X0B.GF3**	14/F03-F04-F05	20Nm	15V - 30V 50/60Hz (12V - 48V DC)	15W	9s	12s
ER35.X0A.GF3**	14/F03-F04-F05	35Nm	100V - 240V 50/60Hz (100V - 350V DC)	15W	19s	26s
ER35.X0B.GF3**	14/F03-F04-F05	35Nm	15V - 30V 50/60Hz (12V - 48V DC)	15W	19s	24s
ER35.90A.GF3	22/F05-F07	35Nm	100V - 240V 50/60Hz (100V - 350V DC)	45W	6s	7s
ER35.90B.GF3	22/F05-F07	35Nm	15V - 30V 50/60Hz (12V - 48V DC)	45W	6s	7s
ER60.90A.GF3	22/F05-F07	60Nm	100V - 240V 50/60Hz (100V - 350V DC)	45W	10s	12s
ER60.90B.GF3	22/F05-F07	60Nm	15V - 30V 50/60Hz (12V - 48V DC)	45W	10s	12s
ER100.90A.GF3	22/F05-F07	100Nm	100V - 240V 50/60Hz (100V - 350V DC)	45W	20s	23s
ER100.90B.GF3	22/F05-F07	100Nm	15V - 30V 50/60Hz (12V - 48V DC)	45W	19s	22s

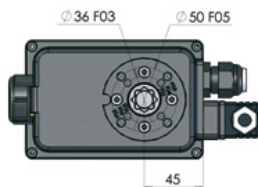

Rafmagnsrótor - LONG OPERATING TIME RANGE

Vörunúmer	Stjarna / Lengd á milli róa	Tog	Spenna	Kraftur	tími án álags	tími án álags
ER35.93A.GF3	22/F05-F07	35Nm	100V - 240V 50/60Hz (100V - 350V DC)	45W	34s	40s
ER35.93B.GF3	22/F05-F07	35Nm	15V - 30V 50/60Hz (12V - 48V DC)	45W	34s	41s
ER60.93A.GF3	22/F05-F07	60Nm	100V - 240V 50/60Hz (100V - 350V DC)	45W	67s	79s
ER60.93B.GF3	22/F05-F07	60Nm	15V - 30V 50/60Hz (12V - 48V DC)	45W	68s	79s
ER100.93A.GF3	22/F05-F07	100Nm	100V - 240V 50/60Hz (100V - 350V DC)	45W	110s	119s
ER100.93B.GF3	22/F05-F07	100Nm	15V - 30V 50/60Hz (12V - 48V DC)	45W	110s	119s

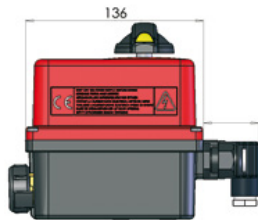

Rafmagnsrótor - STANDARD RANGE

VR 25-45-75 Nm - VS 100-150-300 Nm - VT 600-1000 Nm

Vörunúmer	Stjarna / Lengd á milli róa	Tog	Spenna	Kraftur	tími án álags
VR25.70A.G00	17 F05/F07	25Nm	100V - 240V 50/60Hz (100V - 350V DC)	45W	7s
VR25.70B.G00	17 F05/F07	25Nm	15V - 30V 50/60Hz (12V - 48V DC)	45W	7s
VR45.70A.G00	17 F05/F07	45Nm	100V - 240V 50/60Hz (100V - 350V DC)	45W	15s
VR45.70B.G00	17 F05/F07	45Nm	15V - 30V 50/60Hz (12V - 48V DC)	45W	15s
VR75.70A.G00	17 F05/F07	75Nm	100V - 240V 50/60Hz (100V - 350V DC)	45W	20s
VR75.70B.G00	17 F05/F07	75Nm	15V - 30V 50/60Hz (12V - 48V DC)	45W	20s
VS100.90A.G00	22 F07/F10	100Nm	100V - 240V 50/60Hz (100V - 350V DC)	45W	15s
VS100.90B.G00	22 F07/F10	100Nm	15V - 30V 50/60Hz (12V - 48V DC)	45W	15s
VS150.90A.G00	22 F07/F10	150Nm	100V - 240V 50/60Hz (100V - 350V DC)	45W	30s
VS150.90B.G00	22 F07/F10	150Nm	15V - 30V 50/60Hz (12V - 48V DC)	45W	30s
VS300.90A.G00	22 F07/F10	300Nm	100V - 240V 50/60Hz (100V - 350V DC)	45W	60s
VS300.90B.G00	22 F07/F10	300Nm	15V - 30V 50/60Hz (12V - 48V DC)	45W	60s



Rafmagnsrótor - THREE-PHASE 400V RANGE

VR 25-45-75 Nm - VS 100-150-300 Nm - VT 600-1000 Nm

Vörunúmer	Stjarna / Lengd á milli róa	Tog	Spenna	Kraftur	tími án álags
VR25.709.R00	17 F05/F07	25Nm	400V TRI	20W	10s
VR45.709.R00 17	F05/F07	45Nm	400V TRI	52W	10s
VR75.709.R00 17	F05/F07	75Nm	400V TRI	52W	15s
VS100.909.R00 22	F07/F10	100Nm	400V TRI	135W	10s
VS150.909.R00 22	F07/F10	150Nm	400V TRI	135W	20s
VS300.909.R00 22	F07/F10	300Nm	400V TRI	135W	35s

LOFT- OG RAFMÓTORAR

Rafmagnsrótor - STANDARD RANGE

VR 25-45-75 Nm - VS 100-150-300 Nm VT 600-1000 Nm

Vörunúmer	Stjarna / Lengd á milli róa	Tog	Spenna	Kraftur	tími án álags
VR25.70A.G00	17 F05/F07	25Nm	100V - 240V 50/60Hz (100V - 350V DC)	45W	7s
VR25.70B.G00	17 F05/F07	25Nm	15V - 30V 50/60Hz (12V - 48V DC)	45W	7s
VR45.70A.G00	17 F05/F07	45Nm	100V - 240V 50/60Hz (100V - 350V DC)	45W	15s
VR45.70B.G00	17 F05/F07	45Nm	15V - 30V 50/60Hz (12V - 48V DC)	45W	15s
VR75.70A.G00	17 F05/F07	75Nm	100V - 240V 50/60Hz (100V - 350V DC)	45W	20s
VR75.70B.G00	17 F05/F07	75Nm	15V - 30V 50/60Hz (12V - 48V DC)	45W	20s
VS100.90A.G00	22 F07/F10	100Nm	100V - 240V 50/60Hz (100V - 350V DC)	45W	15s
VS100.90B.G00	22 F07/F10	100Nm	15V - 30V 50/60Hz (12V - 48V DC)	45W	15s
VS150.90A.G00	22 F07/F10	150Nm	100V - 240V 50/60Hz (100V - 350V DC)	45W	30s
VS150.90B.G00	22 F07/F10	150Nm	15V - 30V 50/60Hz (12V - 48V DC)	45W	30s
VS300.90A.G00	22 F07/F10	300Nm	100V - 240V 50/60Hz (100V - 350V DC)	45W	60s
VS300.90B.G00	22 F07/F10	300Nm	15V - 30V 50/60Hz (12V - 48V DC)	45W	60s

Rafmagnsrótor - THREE-PHASE 400V RANGE VR 25-45-75 Nm - VS 100-150-300 Nm VT 600-1000 Nm

Vörunúmer	Stjarna / Lengd á milli róa	Tog	Spenna	Kraftur	tími án álags
VR25.709.R00	17 F05/F07	25Nm	400V TRI	20W	10s
VR45.709.R00	17 F05/F07	45Nm	400V TRI	52W	10s
VR75.709.R00	17 F05/F07	75Nm	400V TRI	52W	15s
VS100.909.R00	22 F07/F10	100Nm	400V TRI	135W	10s
VS150.909.R00	22 F07/F10	150Nm 4	00V TRI	135W	20s
VS300.909.R00	22 F07/F10	300Nm	400V TRI	135W	35ss

Rafmagnsrótor - VT RANGE

VR 25-45-75 Nm - VS 100-150-300 Nm VT 600-1000 Nm

Vörunúmer	Stjarna / Lengd á milli róa	Tog	Spenna	Kraftur	tími án álags
VT600.A08.T00	36 F10/F12	600Nm	230V AC	250W	38s
VT1000.A08.T00	36 F10/F12	1000Nm	230V AC	250W	38s
VT600.A09.T00	36 F10/F12	600Nm	400V TRI	250W	38s
VT1000.A09.T00	36 F10/F12	1000Nm	400V TRI	250W	38s

Rafmagnsrótor - VR 25-45-75 Nm - VS 100-150-300 Nm

Vörunúmer	Stjarna / Lengd á milli róa	Tog	Spenna	Kraftur	tími án álags
VR25.70A.GS2	17 F05/F07	25Nm	100V - 240V 50/60Hz (100V - 350V DC)	45W	7s
VR25.70B.GS2	17 F05/F07	25Nm	15V - 30V 50/60Hz (12V - 48V DC)	45W	7s
VR45.70A.GS2	17 F05/F07	45Nm	100V - 240V 50/60Hz (100V - 350V DC)	45W	15s
VR45.70B.GS2	17 F05/F07	45Nm	15V - 30V 50/60Hz (12V - 48V DC)	45W	15s
VR75.70A.GS2	17 F05/F07	75Nm	100V - 240V 50/60Hz (100V - 350V DC)	45W	20s
VR75.70B.GS2	17 F05/F07	75Nm	15V - 30V 50/60Hz (12V - 48V DC)	45W	20s
VS100.90A.GS2	22 F07/F10	100Nm	100V - 240V 50/60Hz (100V - 350V DC)	45W	15s
VS100.90B.GS2	22 F07/F10	100Nm	15V - 30V 50/60Hz (12V - 48V DC)	45W	15s
VS150.90A.GS2	22 F07/F10	150Nm	100V - 240V 50/60Hz (100V - 350V DC)	45W	30s
VS150.90B.GS2	22 F07/F10	150Nm	15V - 30V 50/60Hz (12V - 48V DC)	45W	30s
VS300.90A.GS2	22 F07/F10	300Nm	100V - 240V 50/60Hz (100V - 350V DC)	45W	60s
VS300.90B.GS2	22 F07/F10	300Nm	15V - 30V 50/60Hz (12V - 48V DC)	45W	60s
VR75.70A.GS2	17 F05/F07	75Nm	100V - 240V 50/60Hz (100V - 350V DC)	45W	20s
VR75.70B.GS2	17 F05/F07	75Nm	15V - 30V 50/60Hz (12V - 48V DC)	45W	20s
VS100.90A.GS2	22 F07/F10	100Nm	100V - 240V 50/60Hz (100V - 350V DC)	45W	15s
VS100.90B.GS2	22 F07/F10	100Nm	15V - 30V 50/60Hz (12V - 48V DC)	45W	15s
VS150.90A.GS2	22 F07/F10	150Nm	100V - 240V 50/60Hz (100V - 350V DC)	45W	30s
VS150.90B.GS2	22 F07/F10	150Nm	15V - 30V 50/60Hz (12V - 48V DC)	45W	30s
VS300.90A.GS2	22 F07/F10	300Nm	100V - 240V 50/60Hz (100V - 350V DC)	45W	60s
VS300.90B.GS2	22 F07/F10	300Nm	15V - 30V 50/60Hz (12V - 48V DC)	45W	60s

Rafmagnsrótor - VR 25-45-75 Nm - VS 100-150-300 Nm

Vörunúmer	Stjarna / Lengd á milli róa	Tog	Spenna	Kraftur	tími án álags
VR25.70A.GP5	17 F05/F07	25Nm	100V - 240V 50/60Hz (100V - 350V DC)	45W	7s (15s*)
VR25.70B.GP5	17 F05/F07	25Nm	15V - 30V 50/60Hz (12V - 48V DC)	45W	7s (15s*)
VR45.70A.GP5	17 F05/F07	45Nm	100V - 240V 50/60Hz (100V - 350V DC)	45W	15s
VR45.70B.GP5	17 F05/F07	45Nm	15V - 30V 50/60Hz (12V - 48V DC)	45W	15s
VR75.70A.GP5	17 F05/F07	75Nm	100V - 240V 50/60Hz (100V - 350V DC)	45W	20s
VR75.70B.GP5	17 F05/F07	75Nm	15V - 30V 50/60Hz (12V - 48V DC)	45W	20s
VS100.90A.GP5	22 F07/F10	100Nm	100V - 240V 50/60Hz (100V - 350V DC)	45W	15s
VS100.90B.GP5	22 F07/F10	100Nm	15V - 30V 50/60Hz (12V - 48V DC)	45W	15s
VS150.90A.GP5	22 F07/F10	150Nm	100V - 240V 50/60Hz (100V - 350V DC)	45W	30s
VS150.90B.GP5	22 F07/F10	150Nm	15V - 30V 50/60Hz (12V - 48V DC)	45W	30s
VS300.90A.GP5	22 F07/F10	300Nm	100V - 240V 50/60Hz (100V - 350V DC)	45W	60s
VS300.90B.GP5	22 F07/F10	300Nm	15V - 30V 50/60Hz (12V - 48V DC)	45W	60s

Rafmagnsrótor - GF3

VR 25-45-75 Nm - VS 100-150-300 Nm

Vörunúmer	Stjarna / Lengd á milli róa	Tog	Spenna	Kraftur	tími án álags
VR25.70A.GF3	17 F05/F07	25Nm	100V - 240V 50/60Hz (100V - 350V DC)	45W	7s
VR25.70B.GF3	17 F05/F07	25Nm	15V - 30V 50/60Hz (12V - 48V DC)	45W	7s
VR45.70A.GF3	17 F05/F07	45Nm	100V - 240V 50/60Hz (100V - 350V DC)	45W	15s
VR45.70B.GF3	17 F05/F07	45Nm	15V - 30V 50/60Hz (12V - 48V DC)	45W	15s
VR75.70A.GF3	17 F05/F07	75Nm	100V - 240V 50/60Hz (100V - 350V DC)	45W	20s
VR75.70B.GF3	17 F05/F07	75Nm	15V - 30V 50/60Hz (12V - 48V DC)	45W	20s
VS100.90A.GF3	22 F07/F10	100Nm	100V - 240V 50/60Hz (100V - 350V DC)	45W	15s
VS100.90B.GF3	22 F07/F10	100Nm	15V - 30V 50/60Hz (12V - 48V DC)	45W	15s
VS150.90A.GF3	22 F07/F10	150Nm	100V - 240V 50/60Hz (100V - 350V DC)	45W	30s
VS150.90B.GF3	22 F07/F10	150Nm	15V - 30V 50/60Hz (12V - 48V DC)	45W	30s
VS300.90A.GF3	22 F07/F10	300Nm	100V - 240V 50/60Hz (100V - 350V DC)	45W	60s
VS300.90B.GF3	22 F07/F10	300Nm	15V - 30V 50/60Hz (12V - 48V DC)	45W	60s

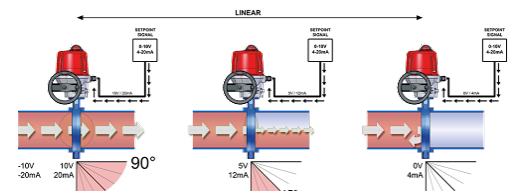

RYÐFRÍIR LOKAR



Kúlulokar - Suðuendi

Vörunúmer	Gerð	Ø	Stærð
V77-4001SP03	Suðuendi	1/2"	2/2
V77-4001SP04	Suðuendi	3/4"	2/2
V77-4001SP05	Suðuendi	1"	2/2
V77-4001SP06	Suðuendi	1 1/4"	2/2
V77-4001SP07	Suðuendi	1 1/2"	2/2
V77-4001SP08	Suðuendi	2"	2/2
V77-4001SP09	Suðuendi DN 65	2 1/2"	2/2
V77-4001SP10	Suðuendi DN 80	3"	2/2
V77-4001SP11	Suðuendi DN 100	4"	2/2



Kúlulokar - FullBore

Vörunúmer	Gerð	Ø	Stærð
V20-2C01SP03	FullBore - DN15	1/2"	316"
V20-2C01SP04	FullBore - DN20	3/4"	316"
V20-2C01SP05	FullBore - DN25	1"	316"
V20-2C01SP06	FullBore	1 1/4"	316"
V20-2C01SP07	FullBore	1 1/2"	316"
V20-2C01SP08	FullBore	2"	316"



Kúlulokar - Ryðfrítt

Vörunúmer	Gerð	Ø	Stærð
V22-1001SP03	Ryðfrítt tvískiptur	1/2"	2/2
V22-1001SP04	Ryðfrítt tvískiptur	3/4"	2/2
V22-1001SP05	Ryðfrítt tvískiptur	1"	2/2
V22-1001SP06	Ryðfrítt tvískiptur	1 1/4"	2/2
V22-1001SP07	Ryðfrítt tvískiptur	1 1/2"	2/2
V22-1001SP08	Ryðfrítt tvískiptur	2"	2/2
V22-1001SP09	Ryðfrítt tvískiptur	2 1/2"	2/2
V22-1001SP10	Ryðfrítt tvískiptur	3"	2/2



Kúlulokar - Ryðfrítt

Vörunúmer	Gerð	Ø	Stærð
V77-1001SP03	Ryðfrítt	1/2"	2/2
V77-1001SP04	Ryðfrítt	3/4"	2/2
V77-1001SP05	Ryðfrítt	1"	2/2
V77-1001SP06	Ryðfrítt	1 1/4"	2/2
V77-1001SP07	Ryðfrítt	1 1/2"	2/2
V77-1001SP08	Ryðfrítt	2"	2/2
V77-1001SP09	Ryðfrítt DN 65	2 1/2"	2/2
V77-1001SP10	Ryðfrítt DN 80	3"	2/2
V77-1001SP11	Ryðfrítt DN 100	4"	2/2



Kúlulokar - frórótor

Vörunúmer	Gerð	Ø
V77-5001SP08B	frórótor PN40 m/flans	2"
V77-5001SP10B	frórótor PN40 m/flans	3"

LOKAR



Loftrótor - Ál

Vörunúmer	Gerð	Virgni	mm
PA15	PA10 F05/F07	Tvívirkur	17
PA15/S	PA/S F05/F07	Einwirkur	17



Loftrótor - ryðfrír

Vörunúmer	Gerð	Virgni	mm
P120	ryðfrír	Tvívirkur	
P120S	ryðfrír	Einwirkur	
P130S	ryðfrír	Einwirkur	
P140S	ryðfrír	Einwirkur	



Loftrótor - plast

Vörunúmer	Gerð	Virgni	mm
PP00	Polyamideplast	Tvívirkur	
PP00S	Plast	Einwirkur með gorm	
PP10	Plast	Tvívirkur	
PP10/S	Plast	Einwirkur	
PP20	Plast	Tvívirkur	
PP20S	Plast	Einwirkur	



Loftrótor - plast

Vörunúmer	Gerð	Virgni	mm
PPW	Plast	Tvívirkur	
PPWS	Plast	Einwirkur með gorm	



Positioner SMART

Vörunúmer	Gerð	mm
PST-303	4-20 mA	P00-F30
PST-A204D	4-20 mA	P00-F30



Stöðuvísir

Vörunúmer	Gerð	Rafmagn	IP
CFC-6301	Stöðuvísir	24-230V	IP67

SÆTIS- SPJALD- HNÍFA- OG KEILULOKAR



Sætislokar - Ryðfrítt

Vörunúmer	Gerð	Ø
BPG206STW00	NC	1/2"
BPG206STX00	NC - O - 1-2 og 2-1	3/4"
BPG207STY00	NC - D40 - 1-2 og 2-1	1"
BPG208STK00	NC - D63 - 1-2 og 2-1	1 1/4"
BPG209STK00	NC - D63 - 1-2 og 2-1	1 1/2"
BPG209STK00	NC - O - D63 - 2>1 Undersea	2"

Einstefnuloki - Ryðfrítt (316)

Vörunúmer	Gerð	Ø
MC1030-1	m/gengjum	1"
MC1030-1-1/2	m/gengjum	1 1/2"
MC1030-1-1/4	m/gengjum	1 1/4"
MC1030-1/2	m/gengjum	1/2"
MC1030-2	m/gengjum	2"
MC1030-3/4	m/gengjum	3/4"
MC1030-3/4	m/gengjum	3/4"

Einstefnulokar - Ryðfrítt (316)

Vörunúmer	Gerð	Ø
MC1050-1-1/2	f/flangs	1 1/2"
MC1050-1-1/4	f/flangs - RF DN32	1 1/4"
MC1050-2	f/flangs - RF DN50	2"
MC1050-2-1/2	f/flangs	2 1/2"
MC1050-3	f/flangs	3"
MC1050-4	f/flangs	4"

Hníflokar - Ryðfrítt

Vörunúmer	Gerð	
AHMK65	DN-65 GGG40	SS304
AHMK80	DN-80 GGG40	SS304
AHMK100	DN-100 GGG40	SS304
AHMK125	DN-125 GGG40	SS304
AHMK150	DN-150 GGG40	SS304

SPJALD- HNÍF- OG KEILULOKAR



Spjaldlokar - Ryðfrítt

Vörunúmer	Gerð	
FAF3560050	DN-50 GG25 EPDM	
FAF3560065	DN-65 GG25 EPDM	
FAF3560080	DN-80 GG25 EPDM	
FAF3560100	DN-100 GG25 EPDM	
FAF3560125	DN-125 GG25 EPDM	
FAF3560150	DN-150 GG25 EPDM	
FAF3560200	DN-200 GG25 EPDM	
FAF3560250	DN-250 GG25 EPDM	
FAF3560300	DN-300 GG25 EPDM	

Spjaldlokar - með handfangi

Vörunúmer	Gerð	Ø
SL0050-VHERK1	DN-50	50 mm
SL0065-VHERK1	DN-65	65 mm
SL0080-VHERK1	DN-80	80 mm
SL0100-VHERK1	DN-100	100 mm
SL0125-VHERK1	DN-125	125 mm
SL0150-VHERK1	DN-150	150 mm

Spjaldlokar - án handfangs

Vörunúmer	Gerð	Ø
SL0050-VHER05	DN-50	50 mm
SL0065-VHER05	DN-65	65 mm
SL0080-VHER05	DN-80	80 mm
SL0100-VHER07	DN-100	100 mm
SL0125-VHER07	DN-125	125 mm
SL0150-VHER07	DN-150	150 mm

SPJALDLOKAR

STERKIR SPJALDLOKAR MEÐ GEGNUMGANGANDI SPINDILL - ENN STERKARI LOKAR

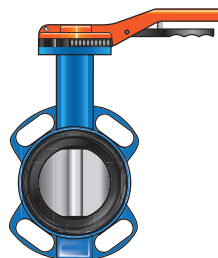
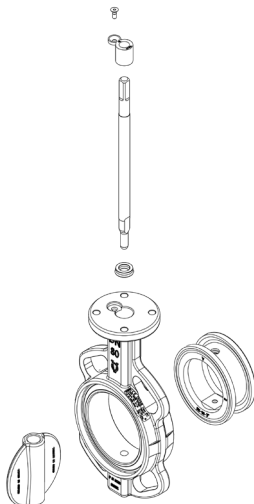

Spjaldlokar

Vörunúmer	Gerð	Stærð mm
115PE0200	Ryðfrítt m/handfang	DN 200-8"
115PE0150	Ryðfrítt m/handfang	DN 150-6"
115PE0125	Ryðfrítt m/handfang	DN 125-5"
115PE0100	Ryðfrítt m/handfang	DN 100-4"
115PE0080	Ryðfrítt m/handfang	DN 80-3"
115PE0065	Ryðfrítt m/handfang	DN 65 2 1/2"
115PE0050	Ryðfrítt m/handfang	DN 50-2"



Kúluloki

Vörunúmer	Gerð	Stærð mm	Plast
VEIV020	Kúluloki	20mm	PVC
VEIV025	Kúluloki	25mm	PVC
VEIV032	Kúluloki	32mm	PVC
VEIV040	Kúluloki	40mm	PVC
VEIV050	Kúluloki	50mm	PVC
VEIV063	Kúluloki	63mm	PVC
VEIV075	Kúluloki	75mm	PVC
VEIV090	Kúluloki	90mm	PVC
VEIV110	Kúluloki	110mm	PVC



Kúluloki - linulaga

Vörunúmer	Gerð	Stærð mm	Plast
VKRIV012E	Kúluloki	20mm	PVC
VKRIV020E	Kúluloki	20mm	PVC
VKRIV025E	Kúluloki	25mm	PVC
VKRIV032E	Kúluloki	32mm	PVC
VKRIV040E	Kúluloki	40mm	PVC
VKRIV050E	Kúluloki	50mm	PVC



Kúluloki - EPDM pakkningar

Vörunúmer	Gerð	Stærð mm	Plast
VKDIV075E	EPDM pakk.	75mm	PVC-U
VKDIV090E	EPDM pakk.	90mm	PVC-U
VKDIV110E	EPDM pakk.	110mm	PVC-U



Loki TKD 3way - EPDM p

Vörunúmer	Gerð	Stærð mm	Plast
LKDIV050E	L-boruð kúla	50	PVCU
LKDIV063E	L-bor	63	PVCU
TKDIV050E	T-boruð kúla	50	PVCU
TKDIV063E	T-boraður	63	PVCU



Strengluki

Vörunúmer	Gerð	Stærð mm	Plast
VVUIV025E	Strengluki	25mm	PVC
VVUIV032E	Strengluki	32mm	PVC
VVUIV040E	Strengluki	40mm	PVC
VVUIV050E	Strengluki	50mm	PVC
VVUIV063E	Strengluki	63mm	PVC



Einstefnuloki - spjald

Vörunúmer	Gerð	Stærð mm	Plast
CROV075E	- spjald	75 mm	PVC
CROV090E	- spjaldi	90 mm	PVC
CROV110E	- spjald	110 mm	PVC
CROV140E	- spjald	D140 DN125	PVC

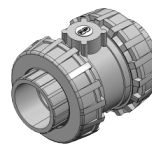

Einstefnuloki - EPDM

Vörunúmer	Gerð	Stærð mm	Plast
SXEIC032E	Einstefnuloki	D32	PVCC
SXEIC040E	Einstefnuloki	D40	PVCC
SXEIC050E	Einstefnuloki	D50	PVCC
SXEIC063E	Einstefnuloki	D63	PVCC



Spjaldluki

Vörunúmer	Gerð	Stærð mm	Plast
FEOVLM050E	-hus m/hand	D50mm	PVC
FEOVLM063E	-hus m/hand	D63mm	PVC
FEOVLM075E	-hus m/hand	D75mm	PVC
FEOVLM090E	-hus m/hand	D90mm	PVC
FEOVLM110E	-hus m/hand	D110mm	PVC
FEOVLM125E	-hus m/hand	D125mm	PVC
FEOVLM140E	-hus m/hand	D140mm	PVC
FEOVLM160E	-hus m/hand	D160mm	PVC
FEOVLM200E	-hus m/hand	D200mm	PVC
FEOVLM225E	-hus m/hand	D225mm	PVC



Millistykki milli loka og rafmótor

Vörunúmer	Gerð	Stærð
PQCE020	Millistykki f/rafmótor	20mm
PQCE025	Millistykki f/rafmótor	25mm
PQCE032	Millistykki f/rafmótor	32mm
PQCE040	Millistykki f/rafmótor	40mm
PQCE050	Millistykki f/rafmótor	40mm
PQCE063	Millistykki f/rafmótor	63mm
fyrir loftmót		
PQCP050	Millistykki f/loftmót	50mm
PQE090	Millistykki f/loftmót	75-90mm
PQE110	Millistykki f/loftmót	110mm



Kúluloki - með rafrótor

Vörunúmer	Gerð	Spenna	Stærð	Plast
VKDIVEM050E	EPDM	230v	50mm	PVC-U
VKDIVSHX025E	m/lás á handfangi	25mm		PVC



Flæðismælir

Vörunúmer	Gerð	???	Plast
FSIV032T1X01600M	150-1600	L/H	PVC
FSIV032T1X0640M	60-640	L/H	PVC
FSIV063P1X0010M	100-10000	L/H	PVC
FSIV050T1x1600	D 50 1500-1600	L/H	PVC



RÖR Í RÖR

NÝJAR LAUSNIR - NÝ HUGMYNDAFRÆÐI

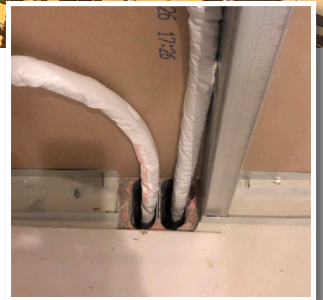
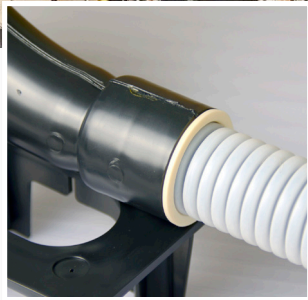

RÖR Í RÖR



Endafesting

Vörunúmer	Gerð	cm
CB400	DN40	18 cm



Endafesting

Vörunúmer	Gerð	cm
CB401	DN40	14 cm



Upphækkun

Vörunúmer	Gerð	cm
	Upphækkun	15 cm



Stækkun

Vörunúmer	Gerð	cm
CB500	Stækkun í DN50	5 cm



Plötufesting

Vörunúmer	Gerð	cm
CB250	Plötufesting	?? cm



Steypubarki

Vörunúmer	Gerð	Ø (mm)	Litur
25310050	720 N	50 mm	Grár
25310040	720 N	40 mm	Grár



Rör fyrir gólfhita

Vörunúmer	Gerð	Ø (mm)	m
83520401	Álpex- duo	20x2 10 bar 95°	100



Rör fyrir gólfhita

Vörunúmer	Gerð	Ø (mm)	m
	Álpex- duo	16x2 10 bar 95°	100

NÝJAR LAUSNIR - NÝ HUGMYNDAFRÆÐI

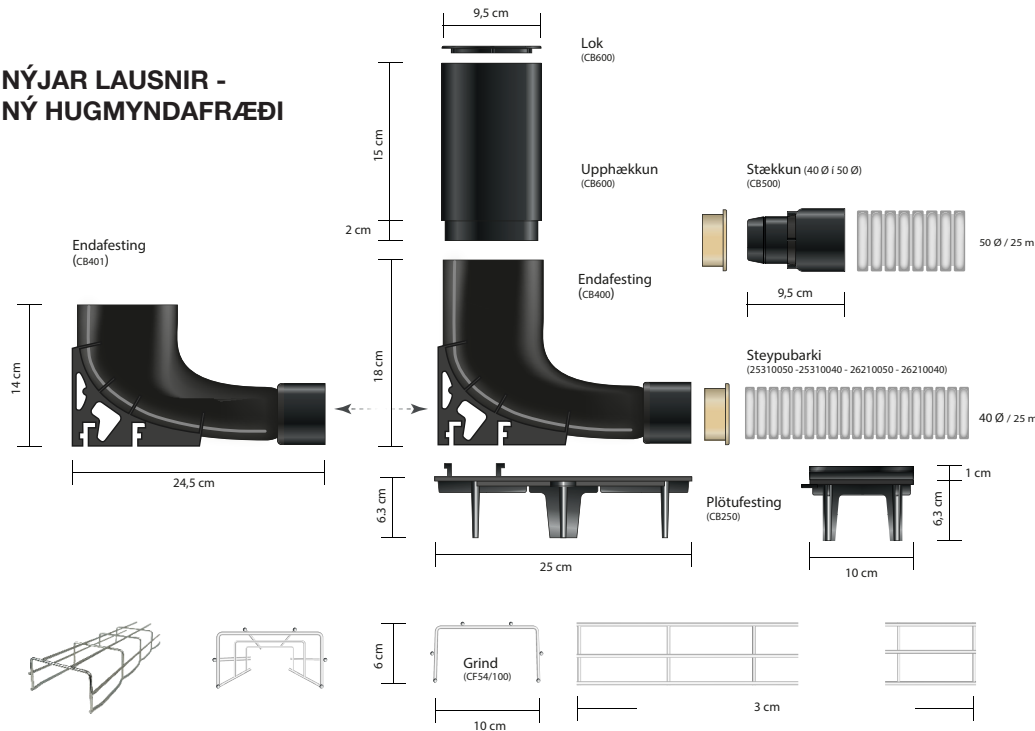

Skannaðu QR kóðann og skoðuðu RÖR Í RÖR kerfið í símanum



Einfalt kerfi - Auðvelt að draga rör í eftir á

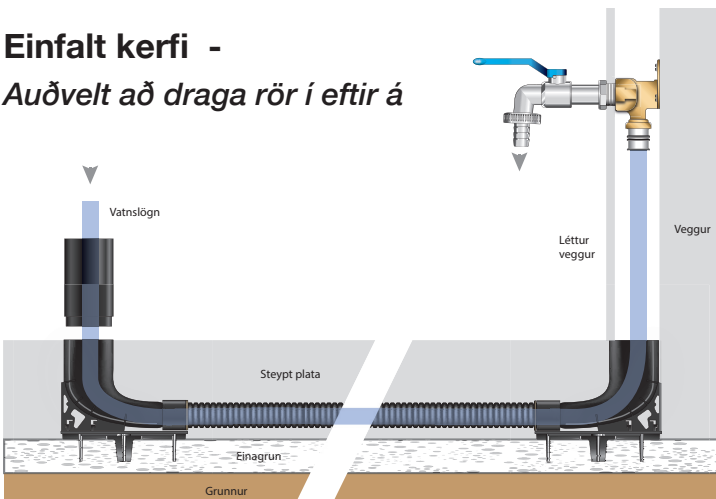

BARKAR FYRIR VATNSLAGNIR

Mjög sterkur barki úr PVC fyrirsteypu 16-63 mm sem auðvelt er að draga rör í eftir á.





PEX- PERT- GÓLFHITALAGNIR

RÖRAKERFI FYRIR NEYSLUVATN OG OFNAKERFI



FRÄNKISCHE

HRAÐTENGI FYRIR ALPEX PLUS RÖR



Hné - alplast

Vörunúmer	Gerð	Ø (mm)
88316200	Álplast PPSU	16-16
88320200	Álplast PPSU	20-20
88326200	Álplast PPSU	26-26



N-hné - kopar

Vörunúmer	Gerð	Ø (mm)
87316880	PPSU	16-16
87326880	PPSU	20-20



Té - alplast

Vörunúmer	Gerð	Ø (mm)
88316300	Álplast PPSU	16
88320300	Álplast PPSU	20
88326300	Álplast PPSU	26



Té - alplast

Vörunúmer	Gerð	Ø (mm)
88320333	Álplast PPSU	20 - 16 - 16
88320330	Álplast PPSU	20 - 16 - 20
88320303	Álplast PPSU	20 - 20 - 16
88326333	Álplast PPSU	26 - 16 - 16
88326335	Álplast PPSU	26 - 16 - 20
88326330	Álplast PPSU	26 - 16 - 26
88326355	Álplast PPSU	26 - 20 - 20
88326350	Álplast PPSU	26 - 20 - 26



Samtengi - álplast

Vörunúmer	Gerð	Ø (mm)
88316100	Álplast PPSU	16 - 16
88320100	Álplast PPSU	20 - 20
88326100	Álplast PPSU	26 - 26



M-hné - kopar

Vörunúmer	Gerð	Ø (mm)	*
87316792	PPSU - IG	16	1/2
87320792	PPSU - IG	20	1/2
87320793	PPSU - IG	20	3/4
87326792	PPSU - IG	26	3/4



M-té - kopar

Vörunúmer	Gerð	Ø (mm)	*
87316742	PPSU	16	1/2
87320742	PPSU	20	1/2
87320743	PPSU	20	3/4
87326743	PPSU	26	3/4



N-hné - kopar

Vörunúmer	Gerð	Ø (mm)	*
87316782	Álplast PPSU	16	1/2
87326782	Álplast PPSU	20	1/2
87326783	Álplast PPSU	20	3/4
87326783	Álplast PPSU	26	3/4



M-tengi - kopar

Vörunúmer	Gerð	Ø (mm)	*
87316772	PPSU - IG	16	1/2
87320772	PPSU - IG	20	1/2
87320773	PPSU - IG	20	3/4
87326773	PPSU - IG	26	3/4
87326774	PPSU - IG	26	1



Minnkun - álplast

Vörunúmer	Gerð	Ø (mm)
88320130	Álplast PPSU	20 - 16
88326130	Álplast PPSU	26 - 20
88320150	Álplast PPSU	26 - 20



Lok - álplast

Vörunúmer	Gerð	Ø (mm)
88316820	Álplast PPSU	16



N-tengi - kopar

Vörunúmer	Gerð	Ø (mm)	*
87316761	PPSU - AG	16	3/8
87316762	PPSU - AG	16	1/2
87320762	PPSU - AG	20	3/8
87320763	PPSU - AG	20	3/4
87326763	PPSU - AG	26	3/4
87326764	PPSU - AG	26	1



N-tengi - kopar

Vörunúmer	Gerð	Ø (mm)	*
87316661	PPSU - IG	16	3/8
87316672	PPSU - IG	16	1/2
87316673	PPSU - IG	16	3/4
87320672	PPSU - IG	20	1/2
87320673	PPSU - IG	20	3/4
87326674	PPSU - IG	26	1



N-tengi - kopar

Vörunúmer	Gerð	Ø (mm)	*
88316762	PPSU - AG	16	1/2
88320762	PPSU - AG	20	1/2
88320763	PPSU - AG	20	3/4



Hné í WC kassa - kopar

Vörunúmer	Gerð	Ø (mm)	*
87316724	PPSU - IG	16	1/2
87316724	PPSU - AG	16	3/4



Vegghné - kopar

Vörunúmer	Gerð	Ø (mm)	*
87316720	PPSU - IG	16	1/2
87320720	PPSU - IG	20	1/2
87316723	PPSU - IG	20	3/4

Union partur
Vinkill - kopar

Vörunúmer	Gerð	Ø (mm)	*
87316850	Vinkill - IG	16	1/2

Husla
til að aftengja hraðfittings

Vörunúmer	Gerð	Ø (mm)
88316900	Husla	16
88320900	Husla	20



Tengiró - PPSU

Vörunúmer	Gerð	Ø (mm)	*
88316710	PPSU - IG	16	3/4

Gegnumstreynir
veggigné

Vörunúmer	Gerð	Ø (mm)	*
87316749	Gegnumstreynir	16	1/2
87320749	Gegnumstreynir	20	3/4

PRESSTENGI FYRIR ALPEX F50 PROFI - PEX OG PE-RT RÖR



Hné 90° - alpeX

Vörunúmer	Gerð	Ø (mm)
88916200	F50 PROFI - PPSU	16
88920200	F50 PROFI - PPSU	20
88926200	F50 PROFI - PPSU	26
88932200	F50 PROFI - PPSU	32



M-hné 90° - Female

Vörunúmer	Gerð	Ø (mm)	*
86916792	F50 PROFI - brass	16	1/2
86920792	F50 PROFI - brass	20	1/2
86920793	F50 PROFI - brass	26	3/4
86926793	F50 PROFI - brass	36	3/4
86932794	F50 PROFI - brass	32	1



N-hné 90° - Male

Vörunúmer	Gerð	Ø (mm)	*
86916782	F50 PROFI - brass	16	1/2
86920782	F50 PROFI - brass	20	1/2
86920783	F50 PROFI - brass	20	3/4
86926783	F50 PROFI - brass	26	3/4
86932784	F50 PROFI - brass	32	1



N-hné 90° - Male

Vörunúmer	Gerð	Ø (mm)	*
86740785	L - brass	40	1 1/4
86750786	L - brass	50	1 1/2



Hné 90° - alpeX

Vörunúmer	Gerð	Ø (mm)
88440200	L - PPSU	40
88450200	L - PPSU	50
88463200	L - PPSU	63
88475200	L - PPSU	75



Té - alpeX

Vörunúmer	Gerð	Ø (mm)
88916300	F50 PROFI - PPSU	16
88920300	F50 PROFI - PPSU	20
88926300	F50 PROFI - PPSU	26
88932300	F50 PROFI - PPSU	32



M-té - kopar

Vörunúmer	Gerð	Ø (mm)	*
86916742	PPSU	16	1/2
86920742	PPSU	20	1/2
86920743	PPSU	20	3/4
86926742	PPSU	26	1/2
86926743	PPSU	26	3/4
86932742	PPSU	32	1/2
86932743	PPSU	32	3/4
86932744	PPSU	32	1



M-té - kopar

Vörunúmer	Gerð	Ø (mm)	*
86740742	PPSU	40	1/2
86740743	PPSU	40	3/4
86750743	PPSU	50	3/4
86763744	PPSU	63	1
86775744	PPSU	75	1



Hálfné 45° - alpeX

Vörunúmer	Gerð	Ø (mm)
88926201	F50 PROFI - PPSU	26
88932201	F50 PROFI - PPSU	32



Té - alpeX

Vörunúmer	Gerð	Ø (mm)
88440300	L - PPSU	40 - 40 - 40
88450300	L - PPSU	50 - 50 - 50
88463300	L - PPSU	63 - 63 - 63
88475300	L - PPSU	75 - 75 - 75



M-tengi - alpeX - Female

Vörunúmer	Gerð	Ø (mm)	*
86916772	F50 PROFI - brass	16	1/2
86920772	F50 PROFI - brass	20	1/2
86920773	F50 PROFI - brass	20	3/4
86926773	F50 PROFI - brass	26	3/4
86926774	F50 PROFI - brass	26	1
86932774	F50 PROFI - brass	32	1
86932775	F50 PROFI - brass	32	1 1/4



M-tengi - alpeX - Female

Vörunúmer	Gerð	Ø (mm)	*
86740774	alpeX L - brass	40	1
86740775	alpeX L - brass	40	1 1/4
86750776	alpeX L - brass	50	1 1/2
86763778	alpeX L - brass	63	2



Hálfné 45° - alpeX

Vörunúmer	Gerð	Ø (mm)
88440201	L - PPSU	40
88450201	L - PPSU	50
88463201	L - PPSU	63
88475201	L - PPSU	75



Té - alpeX

Vörunúmer	Gerð	Ø (mm)
88916350	F50 PROFI - PPSU	16 - 20 - 16
88920353	F50 PROFI - PPSU	20 - 16 - 16
88920330	F50 PROFI - PPSU	20 - 16 - 20
88920303	F50 PROFI - PPSU	20 - 20 - 16
88920360	F50 PROFI - PPSU	20 - 26 - 20
88926353	F50 PROFI - PPSU	26 - 16 - 20
88926355	F50 PROFI - PPSU	26 - 20 - 20
88926350	F50 PROFI - PPSU	26 - 20 - 26
88926303	F50 PROFI - PPSU	26 - 26 - 16
88926305	F50 PROFI - PPSU	26 - 26 - 20
88932330	F50 PROFI - PPSU	32 - 16 - 32
88932356	F50 PROFI - PPSU	32 - 16 - 26
88932350	F50 PROFI - PPSU	32 - 20 - 26
88932366	F50 PROFI - PPSU	32 - 26 - 26
88932360	F50 PROFI - PPSU	32 - 26 - 32



Té - alpeX

Vörunúmer	Gerð	Ø (mm)
88440350	F50 PROFI - PPSU	40 - 20 - 40
88440360	F50 PROFI - PPSU	40 - 26 - 40
88440370	F50 PROFI - PPSU	40 - 32 - 40
86750350	F50 PROFI	50 - 20 - 50
86750360	F50 PROFI	50 - 26 - 50
86750370	F50 PROFI	50 - 32 - 50
88450380	F50 PROFI - PPSU	50 - 40 - 50
86763370	F50 PROFI	63 - 32 - 63
86763380	F50 PROFI	63 - 40 - 63
86763390	F50 PROFI	63 - 50 - 63
86775380	F50 PROFI	75 - 40 - 75
86775390	F50 PROFI	75 - 50 - 75



N-tengi - alpeX - Male

Vörunúmer	Gerð	Ø (mm)	*
86740764	alpeX L - brass	40	1
86740765	alpeX L - brass	40	1 1/4
86740766	alpeX L - brass	40	1 1/2
86750766	alpeX L - brass	50	1 1/2
86750768	alpeX L - brass	50	2
86763768	alpeX L - brass	63	2
86775769	alpeX L - brass	75	2 1/2



Botnloka

Vörunúmer	Gerð	Ø (mm)
88916820	F50 PROFI - PPSU	16
88920820	F50 PROFI - PPSU	20
88926820	F50 PROFI - PPSU	20
88932820	F50 PROFI - PPSU	26

PRESSTENGI FYRIR ALPEX F50 PROFI - PEX OG PE-RT RÖR



N-tengi - alpeX - Male

Vörunúmer	Gerð	Ø (mm)	*
86916762	F50 PROFI - brass	16	1/2
86916763	F50 PROFI - brass	16	3/4
86920762	F50 PROFI - brass	20	1/2
86920763	F50 PROFI - brass	20	3/4
86920764	F50 PROFI - brass	20	1
86926763	F50 PROFI - brass	26	3/4
86926764	F50 PROFI - brass	26	1
86932764	F50 PROFI - brass	32	1
86932765	F50 PROFI - brass	32	1 1/4



Samtengi - alpeX

Vörunúmer	Gerð	Ø (mm)
88616100	PPSU	16 - 16
88620100	PPSU	20 - 20
88626100	PPSU	26 - 26
88632100	PPSU	32 - 32



Samtengi - alpeX

Vörunúmer	Gerð	Ø (mm)
88916100	F50 PROFI - PPSU	16
88920100	F50 PROFI - PPSU	20
88926100	F50 PROFI - PPSU	26
88932100	F50 PROFI - PPSU	32



Samtengi - alpeX L

Vörunúmer	Gerð	Ø (mm)
88440100	PPSU - brass	40
88450100	PPSU - brass	50
88463100	PPSU - brass	63
88475100	PPSU - brass	75



Vegghné - kopar

Vörunúmer	Gerð	Ø (mm)	*
86916720	Álplast PPSU	16	1/2
86920720	Álplast PPSU	20	1/2
86920723	Álplast PPSU	26	3/4
86926720	Álplast PPSU	32	3/4



Samtengi - alpeX

Vörunúmer	Gerð	Ø (mm)
88920130	F50 PROFI - PPSU	20 - 16
88926130	F50 PROFI - PPSU	26 - 16
88926150	F50 PROFI - PPSU	26 - 20
88932150	F50 PROFI - PPSU	32 - 20
88932160	F50 PROFI - PPSU	32 - 26



Unionpartur - alpeX

Vörunúmer	Gerð	Ø (mm)	*
74814103	Tengirö	14	3/4
74816103	Tengirö	16	3/4
74820103	Tengirö	20	3/4

Auka hlutir fyrir alpeX



AlpeX veggplata

Vörunúmer	Gerð	Ø (mm)
84900117	Singel	120
84900118	Gemini	153



AlpeX veggplata

Vörunúmer	Gerð	Ø (mm)
84900119	Veggplata	1200



AlpeX röraklippur

Vörunúmer	Gerð	(mm)
79000220	röraklippur	fyrir allt að 20 mm



MGF pressvél

Vörunúmer	Gerð	(mm)
215592	pressvél	fyrir rör allt að 16 - 32 mm



AlpeX yddarasett

Vörunúmer	Gerð	Ø (mm)
79002250	yddarasett	16-32



AlpeX skrali fyrir yddara

Vörunúmer	Gerð	Ø (mm)
79000251	skrali fyrir yddara	16-32



AlpeX kjaftar

Vörunúmer	Gerð	Ø (mm)
79016600-32600	kjaftar	16-32

Hljóðdempun
á gegnumstreymis hné

Vörunúmer	Gerð	Ø (mm)	*
84900216	Hljóðdempun	16-20	1/2

Hljóðdempun
á vegg hné

Vörunúmer	Gerð	*
84916215	Hljóðdempun	1/2
84926215	Hljóðdempun	3/4

Þéttingasett
f/hné í WC kassa

Vörunúmer	Gerð
89516701	TYP_UP*

RÖR

**PEXa - 6 bar / 95°C**

Vörunúmer	mm	laga	m
71012700	12x2	5 laga	200
71016700	16x2	5 laga	600
71020700	20x2	5 laga	200
71020919	20x2	5 laga	500

**PEXb - 10 bar / 95°C**

Vörunúmer	mm	laga	m
76316700	16x2	5 laga	200
76316900	16x2	5 laga	600
76320700	20x2	5 laga	200
76320900	20x2	5 laga	500

**PEXb - 10 bar / 95°C**

Vörunúmer	mm	laga	m
76316750	16x2	5 laga	200
76316950	16x2	5 laga	600
76320450	20x2	5 laga	100

RÖR FYRIR GÓLFHITA

**Alplast - 6 bar/70°C**

Vörunúmer	mm	laga	m
73516800	16x2	5 laga	240
73516900	16x2	5 laga	600

**PE-RT - 6 bar/70°C**

Vörunúmer	mm	m
75020900	20x2	500

BARKAR

**Sterkur barki - grár**

Vörunúmer	Gerð	mm	m
25310040	FFKuS-EM-F	40	50
25310050	FFKuS-EM-F	50	50

**Barki - svartur**

Vörunúmer	Gerð	mm	m
26210040	FBY-EL-T co2ntrol	40	50
26210040	FBY-EL-T co2ntrol	50	50

ALPEX DUO RÖR

**Alpex duo
PEX-ál-pe - 10 bar/95°C**

Vörunúmer	mm	Lengd/m
83516401	16x2	100 m
83516701	16x2	200 m
83520401	20x2	100 m
83526201	26x2	50 m
835132201	32x2	50 m

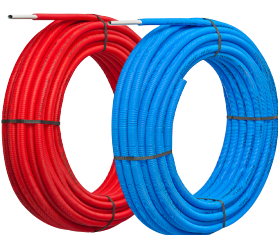
**Alpex duo
Rör í rör - 10 bar/95°C**

Vörunúmer	mm	Litur	Lengd
83616202	16x2	rautt	50 m
83616203	16x2	blátt	50 m
83620202	20x2	rautt	50 m
83620203	26x2	blátt	50 m

**Rör með einangrun
10 bar/95°C**

Vörunúmer	mm	Einangrun/mm	Lengd
83716214 / 7	16x2	9-13	50 m
83720214 / 7	20x2	9-13	50 m
83726214 / 7	26x3	9-13	50 m
83732214 / 7	32x3	9-13	50 m

**Alpex duo PEX-ál-pe
stangir - 10 bar/95°C**

Vörunúmer	mm	Einangrun/mm	Lengd
83516001	16x2	75	5 m
83520001	20x2	50	5 m
83526001	26x2	25	5 m
83532001	32x2	20	5 m

HELSTU KOSTIR



ENDING

EINFALT
KERFI

HREINLÆTI

ENGIN
ÚTFELLINGÖRUGGT
GÆÐAEFNIMIKIÐ
VÖRUURVAL**alpex L - kerfi**

Stærðir Ø	32	40	50	65
Mál [mm]	40 x 3.5	50 x 4.0	63 x 4.5	75x5.0
Hitastug [°C]	max. 95 (permanent)			
Þrýstingur [bar]	max. 10			
Efnisflokkur DIN EN 13501-1	E			
Notkun	Drykkjarvatn og fyrir ofnakerfi			

alpex L - Rör

Efni	PE-X/AL/PE-HD
Hitaleiðni [W/(m·K)]	0.45
Stækkun [mm/(m·K)]	0.026

alpex L - Fittings

Gerð	Hraðtengi	Pressutengi
Efni	Pólýfensýlsúlfón (PPSU); Zink- og brassvörn (dim. 75 mm)	Zink- og brassvörn
Kápa	Stainless steel	
Fyrir pressutöng	contour F	
Lekakerfi acc. til W534	Já	

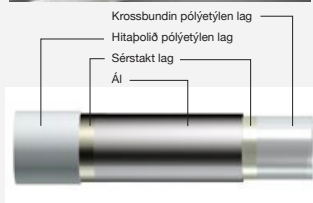

FRÄNKISCHE

Profitherm ÁL/PERT

Profitherm ÁL er nýjasta þjála margalaga rör í stærðinni **16x2 mm**. Þetta rör er sérstaklega hannað fyrir gólfhita og kællilausnir, inniheldur mjög þunna állþinnu sem uppfyllir alla staðla hvað varðar stöðugleika. Þetta gefur möguleika á beygjuradius (5xD) sem hægt er að ná fram með höndum án þess að nota sérstök tæki. Hægt er að nota þetta í öllum byggingum.

Innra og ytra birði röra er **PE-RT** og innri kjarni úr áli (**PE-RT/ÁL/PE-RT**). Þessi þrjú lög eru sérstaklega bundin saman með sérstöku lími – hönnuð með áreiðanleika og endingu að leiðarljósi.

Profitherm ÁL rör eru tengd samana með PPSU fittings.

Kostir:

- Frábær hljóðeinangrun
- Einstakt flæði
- Engin tæring
- Efnapolið
- Hámarkshiti 70°C – stöðugt flæði
- Hámarksþrýstingur: 6 bar
- Súrefniskápa – ágegnsett ál lag
- Stærð: 16x2mm
- Mögulegar lengdir: 240 og 600m

ff-therm ML5 Difustop

5 laga rör hönnuð fyrir hitakerfi og gólfhitakerfi í stærðum **16x2 mm** og **20x2 mm** sem virkar með **FRÄNKISCHE** krumpufittings og hraðfittings.

Sérstök aðferð við gerð **ML5 röranna** gerir það kleift að framleiða rörin í einu skrefi þar sem sértakt lím er notað til þess að setja saman PE-Xb í innralagi og PE í ytralagi við kjarna **EVOH** súrefnis kápu.

Með því að að hafa **EVOH** lagið í kjarna pípunnar er hún varin gegn ytri áhrifum s.s. hita, raka og rispum sem tryggir hámarks öryggi. Tilvalið fyrir erfiðar aðstæður á byggingarstað.

Vegna framleiðsluáferðarinnar þola rörin aflögun og annað álag betur. Sérstök öldrunarefni og sveiflujöfnun halda rörunum sveigjanlegum og tryggja stöðuleika í hita.

Sveigjanleiki röranna gerir alla uppsetningu hraða og þægilega.

Tæknileg atriði:

- Hámarkshiti 95°C
- Hámarksþrýstingur 6 bar
- Súrefniskápa staðal DIN 4726
- Má nota skv. staðli EN 15875 4/5

Notkun: Gólfhitakerfi, hita- og ofnalagnir

Stærðir: 16x2, 20x2mm

Lengdir: 120m, 200m, 240m, 600m

Kostir:

- Frábær ending
- Góð rör sem má þakka EVOH lagi
- Mjög sterkt gegn núnin
- Þægilegt í uppsetningu

ff-therm multi Difustop PE-Xa /PE-RT með súrefniskápu

ff-therm multi Difustop PE-Xa og **PE-RT** rör eru í stærðum 16 og 20 mm sem hægt er að nota með **PPSU** og hraðfittings.

Þrýsti og hitapolin rör **FRÄNKISCHE ff-therm** rör hafa verið notuð með góðum árangri í yfir 300.000 byggingum.

ff-therm multi Difustop PE-Xa og **PE-RT** rör með súrefniskápu eru sérstaklega þægileg fyrir hita- og ofnalagnir.

Krossbinding röranna er tryggð með saltbaðs krossbindingar aðferð byggð **Pont a'Mousson(PAM)**. Sérstök öldrunar- og stöðuleikamiðlar tryggja sveigjanleika og hitastöðugleika. **PE-RT** er búið til úr **PE (polyethylene)** sem er með aukid hitanæmni og er því tilvalið fyrir hita og ofnakerfi.

Einstök uppbygging **PE-RT** röra er að það hefur mikinn styrk. Einstakur sveigjanleiki tryggir hraða og auðveldar uppsetningu.

ff-therm multi Difustop PE-Xa:

- Hámarkshiti **95°C**
- Hámarksþrýstingur **6 bar**
- **DIN:** 3V308
- Notkunarstaðall 4/5
- Súrefniskápa skv. staðli DIN4726
- **Stærðir:** 14x2, 16x2, 17x2, 20x2 og 25x2,3
- **Lengdir:** 120 m og 600 m

ff-therm multi Difustop PE-RT:

- Hámarkshiti **70°C**
- Hámarksþrýstingur **4 bar**
- **DIN:** 3V327
- Súrefniskápa skv. staðli DIN4726
- **Stærðir:** 14x2, 16x2, 17x2 og 20x2
- **Lengdir:** 200 m og 600 m



Hitastillir þráðlaus

Vörunúmer	Gerð
BA010409	FTRB-280.119 hv.gla



Tengibox

Vörunúmer	Gerð
DA480300	vírað 8 termó IP65 f/dreifik.



Hitastillir þráðlaus

Vörunúmer	Gerð
BA010200	m/dysplay hv.gla



Hitastillir á vegg

Vörunúmer	Gerð
MA010000	Hitastillir á vegg víraður



Móttakari

Vörunúmer	Gerð
BA120400	8 rása þráðlau IP65 f/dreifik.
BA120600	4 rása IP65 þráðl. f/dreifik.
DA480500	vírað 5 termó IP20 f/dreifik.



Hitastillir - þráðlaus

Vörunúmer	Gerð
G8000422	á ofna þráðlaus



Samskipateining

Vörunúmer	Gerð
BA210101	B@HOME GATE 2000



Hitastillir - þráðlaus

Vörunúmer	Gerð
BA110300	Hitastillir á rafmsgnsofna



Mótorloki

Vörunúmer	Gerð
H9100010	f/dreifikistur 230V 50Hz.



Stýrilokar á dreifikistu

Vörunúmer	Gerð
G8990010	f/dreifikistur 230V 50Hz - M30 x 1,5

Nýir stýrilokar á dreifikistu
Sama hitastig á öllum mottum (slaufum)

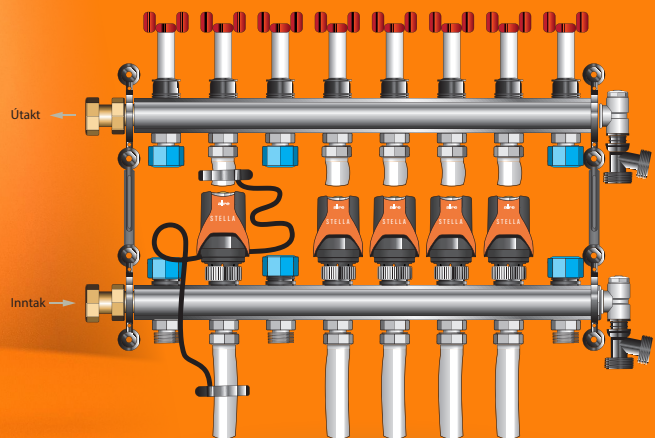



HEILDARLAUSNIR FYRIR GÓLFHITAKERFI



GÓLFHITAKISTUR



UPPBLÖNDUNARLOKAR



HRINGRÁSARDÆLUR



GÓLFHITASTÝRING



VARMASKIPTIR

LAUSNIR FYRIR HITASTÝRINGU

GÓLFHITAKISTUR - RYÐFRÍTT STÁL EÐA BRASS - FLÆÐIMÆLIR 0-5 L / MÍN - STJÓRNLOKI M30X1.5



Dreifrikista - Brass m/flæðiglösóm

Vörunúmer	Gerð	Ø	Stútar
ATE-OR-MDTV-02B	Brass	1"	2
ATE-OR-MDTV-03B	Brass	1"	3
ATE-OR-MDTV-04B	Brass	1"	4
ATE-OR-MDTV-05B	Brass	1"	5
ATE-OR-MDTV-06B	Brass	1"	6
ATE-OR-MDTV-07B	Brass	1"	7
ATE-OR-MDTV-08B	Brass	1"	8
ATE-OR-MDTV-09B	Brass	1"	9
ATE-OR-MDTV-10B	Brass	1"	10
ATE-OR-MDTV-11B	Brass	1"	11
ATE-OR-MDTV-12B	Brass	1"	12

Dreifrikista - Ryðfrítt m/flæðiglösóm

Vörunúmer	Gerð	Ø	Stútar
ATE-OR-MDTV-02C	Ryðfrítt	1"	2
AORE03FLTVEU	Ryðfrítt	1"	3
AORE04FLTVEU	Ryðfrítt	1"	4
AORE05FLTVEU	Ryðfrítt	1"	5
AORE06FLTVEU	Ryðfrítt	1"	6
AORE07FLTVEU	Ryðfrítt	1"	7
AORE08FLTVEU	Ryðfrítt	1"	8
AORE09FLTVEU	Ryðfrítt	1"	9
AORE10FLTVEU	Ryðfrítt	1"	10
AORE11FLTVEU	Ryðfrítt	1"	11
AORE12FLTVEU	Ryðfrítt	1"	12

UPPBLÖNDUNARLOKAR - THERMOSTATIC VTA372-572 - MÓTORSTÝRÐIR MEÐ ÚTIHITASTÖÐ



Blöndunarlok

Sería VRG131 - Inngengur

Númer	Tivisun	DN	*Kvs	Tenging	A [mm]	B [mm]	C [mm]	D [mm]	E [mm]	Þyngd [kg]	Kemur í staðinn
11600100	VRG131	15	0,4	Rp ½"	36	72	32	50	36	0,40	
11600200	VRG131	15	0,63	Rp ½"	36	72	32	50	36	0,40	11000200
11600300	VRG131	15	1	Rp ½"	36	72	32	50	36	0,40	11000300
11600400	VRG131	15	1,6	Rp ½"	36	72	32	50	36	0,40	11000400, 11000500
11600500	VRG131	15	2,5	Rp ½"	36	72	32	50	36	0,40	11000100
11600600	VRG131	15	*4	Rp ½"	36	72	32	50	36	0,40	
11600700	VRG131	20	2,5	Rp ¾"	36	72	32	50	36	0,43	
11600800	VRG131	20	4	Rp ¾"	36	72	32	50	36	0,43	11000700
11600900	VRG131	20	6,3	Rp ¾"	36	72	32	50	36	0,43	11001100, 11050100
11601000	VRG131	25	6,3	Rp 1"	41	82	34	52	41	0,70	11001600
11601100	VRG131	25	10	Rp 1"	41	82	34	52	41	0,70	11002400, 11050200
11601200	VRG131	32	16	Rp 1½"	47	94	37	55	47	0,95	11002700, 11050300
11603400	VRG131	40	25	Rp 1½"	53	106	44	62	53	1,68	11050400, 11601300
11603600	VRG131	50	40	Rp 2"	60	120	46	64	60	2,30	11050600, 11601400

Blöndunarlok

Sería VRG132 - Útgengur

Númer	Tivisun	DN	*Kvs	Tenging	A [mm]	B [mm]	C [mm]	D [mm]	E [mm]	Þyngd [kg]	Kemur í staðinn
11601500	VRG132	15	0,4	G ¾"	36	72	32	50	36	0,40	
11601600	VRG132	15	0,63	G ¾"	36	72	32	50	36	0,40	
11601700	VRG132	15	1	G ¾"	36	72	32	50	36	0,40	
11601800	VRG132	15	1,6	G ¾"	36	72	32	50	36	0,40	
11601900	VRG132	15	2,5	G ¾"	36	72	32	50	36	0,40	
11602000	VRG132	15	4	G ¾"	36	72	32	50	36	0,40	
11602100	VRG132	20	2,5	G 1"	36	72	32	50	36	0,43	
11602200	VRG132	20	4	G 1"	36	72	32	50	36	0,43	
11602300	VRG132	20	6,3	G 1"	36	72	32	50	36	0,43	11001300
11602400	VRG132	25	6,3	G 1½"	41	82	34	52	41	0,70	
11602500	VRG132	25	10	G 1½"	41	82	34	52	41	0,70	11002600
11602600	VRG132	32	16	G 1½"	47	94	37	55	47	0,95	11002900
11603500	VRG132	40	25	G 2"	53	106	44	62	53	1,69	11602700
11603700	VRG132	50	40	G 2½"	60	120	46	64	60	2,30	11602800

*Kvs = m³/h

ÚTIHITASTÖÐ



Hitastýring - úti og inni hitastig

Sería CRD100

Virður hiastillir - nemi fyrir framrás

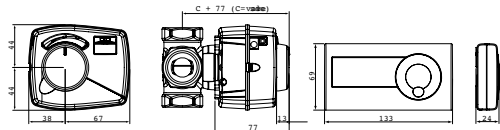

Númer	Tivisun	Spenna [V AC]	Tog [Nm]	Mælir í herbergi	Þyngd [kg]
12682200	CRD122	230	6	Þráðlaust	1,2



Hitastýring - inni

Sería CRB100

Þráðlaust hitastillir - nemi fyrir framrás

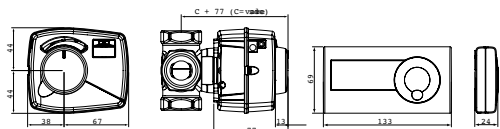

Númer	Tivisun	Spenna [V AC]	Tog [Nm]	Mælir í herbergi	Athugun	Kemur í staðinn
12662200	CRB122	230	6	Þráðlaust		12662100



Hitastýring með veðurstöð fyrir ofnakerfi/gólfhita

Sería CRC110

Útinemi - nemi fyrir framrás

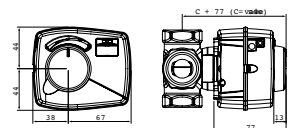

Númer	Tivisun	Spenna [V AC]	Tog [Nm]	Athugun
1280100	CRC111	230	6	

Sjá nánar á bls. ??

LAUSNIR FYRIR HITASTÝRINGU

HRINGRÁSARDÆLUR - ÞREPASTÝRÐAR - STIGLAUSAR



Dæla - Ryðfrítt

Vörunúmer	Gerð	Ø	Stærð
979521701	GHN 25/40 þrepasyrd	1½"	130 mm
979521703	GHN 25/60 þrepasyrd	1½"	130 mm
979521710	GHN 25/40 þrepasyrd	1½"	180 mm
979521765	SAN ECO 15/40 B Neysluvatns		130 mm
979522048	NMT 32/60 stigalaus	2"	180 mm
979523842	NMT 25/40 stigalaus	2½"	130 mm
979523843	NMT 15/60 stigalaus	1"	130 mm
979523845	NMT 25/60 stigalaus	1½"	130 mm
979523848	NMT 25/80 stigalaus	1½"	130 mm
979523853	NMT 25/60 stigalaus	1½"	180 mm
979523848	NMT 25/80 stigalaus	1½"	180 mm

HRINGRÁSARDÆLUR - M/SKJÁ



Dæla - m/skjá

Vörunúmer	Gerð	Ø	Stærð
UGF6131LCDST	15/60	G1"	130 mm

VARMASKIPTIR - K SERÍA MEÐ MARGAR STÆRÐIR SEM ER NOTAÐ Í HITUNAR- OG KÆLINGU.



Varmaskipti - Ryðfrítt

Vörunúmer	Gerð	Ø	Stærð
V77-1001SP03	Ryðfrítt	½"	2/2
V77-1001SP04	Ryðfrítt	¾"	2/2
V77-1001SP05	Ryðfrítt	1"	2/2
V77-1001SP06	Ryðfrítt	1 ¼"	2/2
V77-1001SP07	Ryðfrítt	1 ½"	2/2

V77-1001SP08	Ryðfrítt	2"	2/2
V77-1001SP09	Ryðfrítt DN 65	2 ½"	2/2
V77-1001SP10	Ryðfrítt DN 80	3"	2/2
V77-1001SP11	Ryðfrítt DN 100	4"	2/2

HITASTÝRING



Mótorloki

Vörunúmer	Gerð
H9100010	f/dreifiskstur 230V 50Hz - M30 x 1,5



Stýrilokar á dreifiskistu

Vörunúmer	Gerð
G8990010	f/dreifiskstur 230V 50Hz - M30 x 1,5

STÝRINGAR FYRIR GÓLFHITA - ÞRÁÐLAUSAR EÐA BEINTENGÐAR



Hitastillir þráðlaus

Vörunúmer	Gerð
BA010409	FTRB-280.119 hv.gla



Tengibox

Vörunúmer	Gerð
DA480300	vírað 8 termó IP65 f/dreifik.



Hitastillir þráðlaus

Vörunúmer	Gerð
BA010200	m/dysplay hv.gla



Hitastillir á vegg

Vörunúmer	Gerð
MA010000	Hitastillir á vegg víraður



Móttakari

Vörunúmer	Gerð
BA120400	8 rása þráðlau IP65 f/dreifik.
BA120600	4 rása IP65 þráðl. f/dreifik.
DA480500	vírað 5 termó IP20 f/dreifik.



Hitastillir - þráðlaus

Vörunúmer	Gerð
G8000422	á ofna þráðlaus



Samskipateining

Vörunúmer	Gerð
BA210101	b@home GATE 2000



Hitastillir - þráðlaus

Vörunúmer	Gerð
BA110300	Hitastillir á rafmagnssofna

LAUSNIR FYRIR HITASTÝRINGU

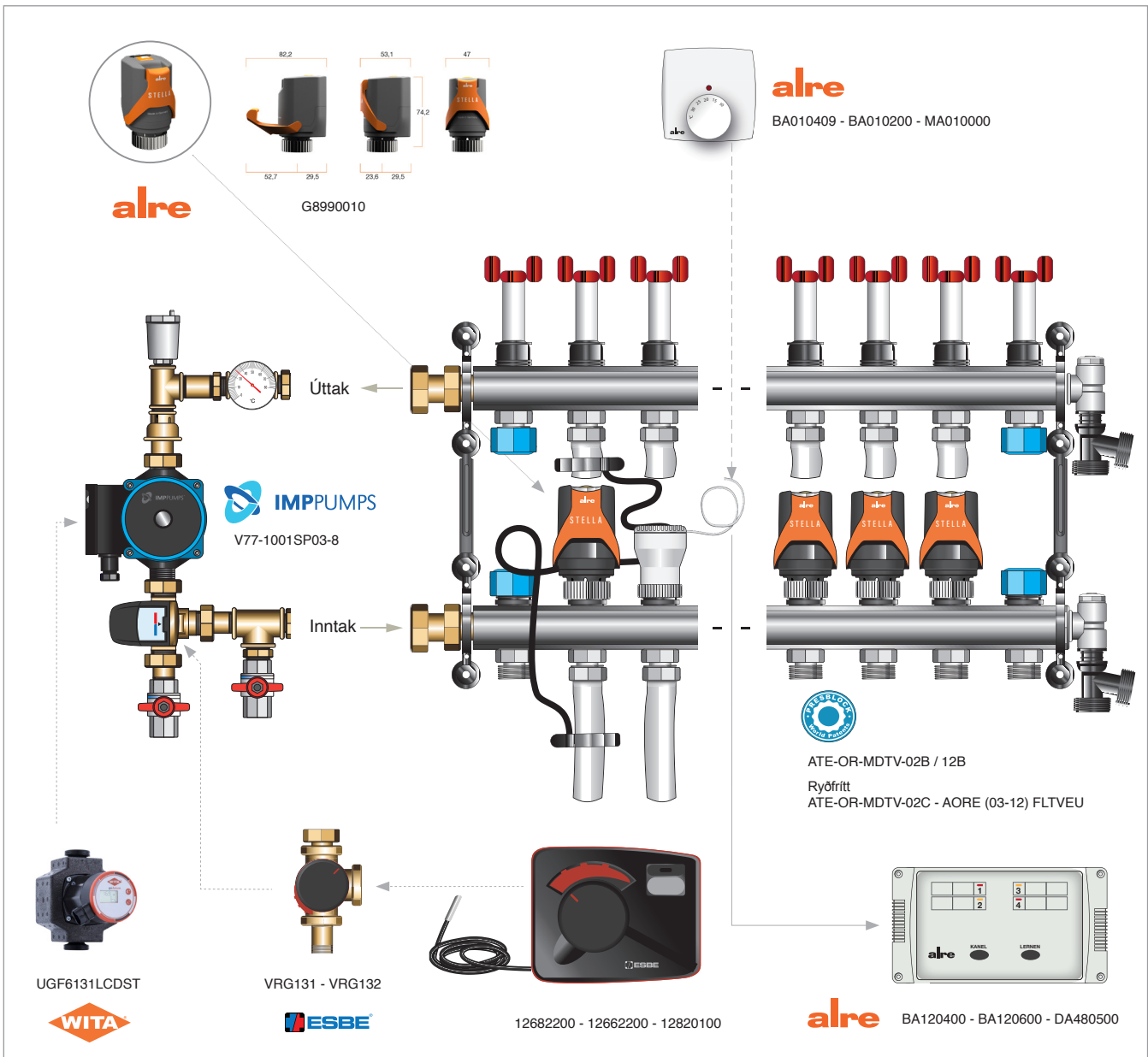

alre

Stýringar fyrir gólfhita og ofna

Práðlausar eða beintengdar

b@home
by **alre**

Práðlaust hitastýringum

B@home kerfinu geturðu stjórnað og fylgst með hita- og kælikerfi þínu. Hægt er að stjórna hverju herbergi fyrir sig á einföldu viðmóti. Og þú getur auðveldlega stjórnað b@home kerfinu fráðlausla á netinu.



b@home
by **alre**

Snjallar lausnir í hitastýringum, heima eða í sumarhúsinu





NIÐURFÖLL OG ÞAKRENNUR

FRÁRENSLI - SALERNISGRINDUR OFL.



Nicoll

by aliaxis

CLASS A15 - Ætlað fyrir fótgangandi og hjólreiðaumferð



Renna

Vörunúmer	Gerð	Stærð mm	Lengd
CABS773	Grá m/vatnslás	128x54,5	50 cm



Renna

Vörunúmer	Gerð	Stærð mm	Lengd
CAB773	Grá renna	128x54,5	50 cm



Renna

Vörunúmer	Gerð	Stærð mm	Lengd
CAB133A	Dökk grá renna	128x54,5	3 m



Rist- v/CABS773 - CAB773

Vörunúmer	Gerð	Stærð mm	Lengd
GR77	PVC	128x54,5	50 cm



Rist

Vörunúmer	Gerð	Stærð mm	Lengd
GR77PB	Hvít gólfrenna	128x54,5	50 cm

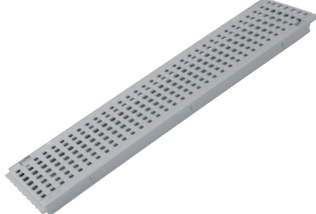

Renna

Vörunúmer	Gerð	Stærð mm	Lengd
GR77P	PVC grár	128x54,5	50 cm



Rist

Vörunúmer	Gerð	Stærð mm	Lengd
GDR10AHP	Svart Polyam	128x54,5	50 cm



Rist

Vörunúmer	Gerð	Stærð mm	Lengd
GDR10ATI	Ryðfrí gólfrenna	128x54,5	1 cm
GDR10AP	Galv. gólfrenna	128x54,5	1 cm

CLASS B125 - Ætlað fyrir fótgangandi, einkabílastæði eða minni bílaumferð



Renna PP

Vörunúmer	Gerð	Stærð mm	Lengd
CAN10BN	Polyam grind	115-136	1 m



Renna PP

Vörunúmer	Gerð	Stærð mm	Lengd
CAL10BF	Pott grind svört	103-136	1 m



Renna PP

Vörunúmer	Gerð	Stærð mm	Lengd
CAN10BCI	Ryðfrí grind	115-136	1 m



Rist - v/CABS773 - CAB773 - CAB773

Vörunúmer	Gerð	Stærð mm	Lengd
GR77	PVC	128x54,5	50 cm

CLASS C250 - Ætlað fyrir svæði með léttari bílaumferð



Renna PP

Vörunúmer	Gerð	Stærð mm	Lengd
DR102CN	Polyam grind - svört	170x136	1 m



Renna PP

Vörunúmer	Gerð	Stærð mm	Lengd
DR102CF	Pott grind svört	170x136	1 m



Renna PP

Vörunúmer	Gerð	Stærð mm	Lengd
DR100CN	Polyam grind svört	80x136	1 m



Renna PP

Vörunúmer	Gerð	Stærð mm	Lengd
DR100CF	Pott grind svört	80x136	1 m

CLASS E400

Ætlað fyrir hraðbrautir, bílastæði og öll ökutæki.



Renna

Vörunúmer	Gerð	Stærð mm	Lengd
DR202DF	Pott grind svört	237x249	1 m



Renna

Vörunúmer	Gerð	Stærð mm	Lengd
DR102DF	Pott grind svört	170x136	1 m

CLASS E600 -

Ætlað fyrir svæði með mikilli umferð, t.d. iðnaðarplön eða hafnarsvæði.



Renna PP

Vörunúmer	Gerð	Stærð mm	Lengd
DR102EF	Pott grind svört	170x136	1 m



Renna PP

Vörunúmer	Gerð	Stærð mm	Lengd
DR302EF	Pott grind svört	369x361	1 m

Samtengi

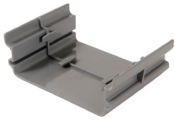

Samtengi

Vörunúmer	Gerð	Stærð mm
NAH773	fyrir CAB133A rennur	128x54,4 mm

Rennuendar



Rennuendi

Vörunúmer	Gerð	Stærð mm
NAH773	fyrir CAB773 rennu	40 mm
	CABS773 m/vatnslás	54,5x128 mm



Rennuendi

Vörunúmer	Gerð	Stærð mm
NJDR100	fyrir DR100CN rennu	50 mm
		80x136 mm



Rennuendi

Vörunúmer	Gerð	Stærð mm
NAV178	fyrir CAL10BF rennu	110 mm



Rennuendi

Vörunúmer	Gerð	Stærð mm
NAV177	Grátt - fyrir CAN177	110 mm
NAV177N	Svart - fyrir CAN177	110 mm



Rennuendi

Vörunúmer	Gerð	Stærð mm
NVDR102	fyrir DR102CN rennu	110 mm
		170x136 mm



Rennuendi

Vörunúmer	Gerð	Stærð mm
NZDR202	fyrir DR102CN rennu	160 mm
		170x136 mm



Lóðrétt úrtak

Vörunúmer	Gerð	Stærð mm
SBDR20	fyrir ?????? rennu	200 mm
		237x249 mm



Lóðrétt úrtak

Vörunúmer	Gerð	Stærð mm
STCAB13	fyrir CAL10BF CAN177 / CAN10BN CAL10BF / DRP178	110 mm



Lóðrétt úrtak

Vörunúmer	Gerð	Stærð mm
SVCAN	fyrir CAL10BF CAN177 / CAN10BN CAL10BF / DRP178	110 mm

Niðurföll



Sandfang

Vörunúmer	Gerð	Stærð mm
PSCVV	Sandfang	110 mm



Niðurfall

Vörunúmer	Gerð	mm	Ø
SCP1110	m/vatnslás	20x20	110mm



Niðurfall

Vörunúmer	Gerð	mm	Ø
SC456G	m/vatnslás - ljós grátt	150x150	50
SC456	m/vatnslás - svart	150x150	50



Niðurfall

Vörunúmer	Gerð	mm	Ø
SK1110G	m/vatnslás - ljós grátt	250x250	110
SK1110	m/vatnslás - svart	250x250	110

Aukahlutir



Vatnslás

Vörunúmer	Gerð	Stærð mm
SSVCAN	f/CAB133A	40/50 - 110 mm



Vatnslás

Vörunúmer	Gerð	Stærð mm
YV1	Vatnslás	110 mm



Skrúfusettt v/CAB rennur

Vörunúmer	Gerð
FIXCAB13	Galv. sknúfusettt v/CAB rennur



Skrúfur v/CAN ristum

Vörunúmer	Gerð	Magn
FIXCAN	sknúfur fyrir CAN ristum	12 stk

CLASS A15 - Ætlað fyrir frárennsli á svölum og sundlaugar ofl.

CONNECTO®



CAB133A
Renna dökk grá - 128x54,5 - 3 m

NAHJ13
Enda úttak v/rennu - 50 mm

GDR10AP
Rist v/CAB rennur
Galvaniserað stál

GDR10AHPP
Rist v/CAB rennur
Svart Polyam

GDR10ATI
Rist v/CAB rennur
Ryðfrí gólfrenna

PVC

Litr

GRL77 / GRL77S / GRL77K

GR77P / GR77PS / GR77PB

FIXCAB13
Skrúfuset v/CAB rennur

SSVCAN
Vatnssál - 40/50 - 110 mm

STCAB13
Lóðrétt úrtak - 110 mm

JCAB13
samtengi v/CAB rennur
- 128x54,5 mm

PSCVV
Enda úttak sandfang 110 mm

CLASS A15 - Ætlað fyrir fótgangandi og hjólréiðumferð

CONNECTO®



CABS773 / CABS773S
Renna m/vatnslás 128x54,5 mm - 50 cm

CAB773 / CAB773S
Renna 128x54,5 mm - 50 cm

GR77P / GR77PS / GR77PB
PVC rist - 128x54,5 - 50 cm

GDR10AP
Rist v/CAB rennur
Galvaniserað stál

GDR10AHPP
Rist v/CAB rennur
Svart Polyam

GDR10ATI
Rist v/CAB rennur
Ryðfrí gólfrenna

FIXCAN
Skrúfuset v/CAB rennur skrúfur
fyrir CAN ristum, 12 stk

SVCAN
Enda úttak 110 mm

NAH773
Rennuendi v/CAB773 rennu - 40 mm

GRL77 / GRL77S / GRL77K
PVC rist - 128x54,5 - 50 cm

PSCVV
Enda úttak sandfang 110 mm

CLASS B125 - Ætlað fyrir fótgangandi, einkabílastæði eða minni bílaumferð

CONNECTO®



CAN10BN
Renna PP 115-136 mm - 1 m
Polyamide grind

NAV178
Enda úttak - fyrir CAL10BF / CAN10BN - 110 mm

CAL10BF
Renna PP 115-136 mm - 1 m
Ryðfrítt stál

GR77
Rist fyrir CABS773 / CAB773 / CAN10BN rennur
50 cm - PVC

NAV177 / NAV177N
Enda úttak - fyrir CAN177 - 110 mm
Grá eða svart

SVCAN
Lóðrétt úrtak fyrir CAN177 / CAN10BN / CAL10BF / DRP178 - 110 mm

PSCVV
Enda úttak sandfang 110 mm

CLASS C250 - Ætlað fyrir svæði með léttri bílaumferð

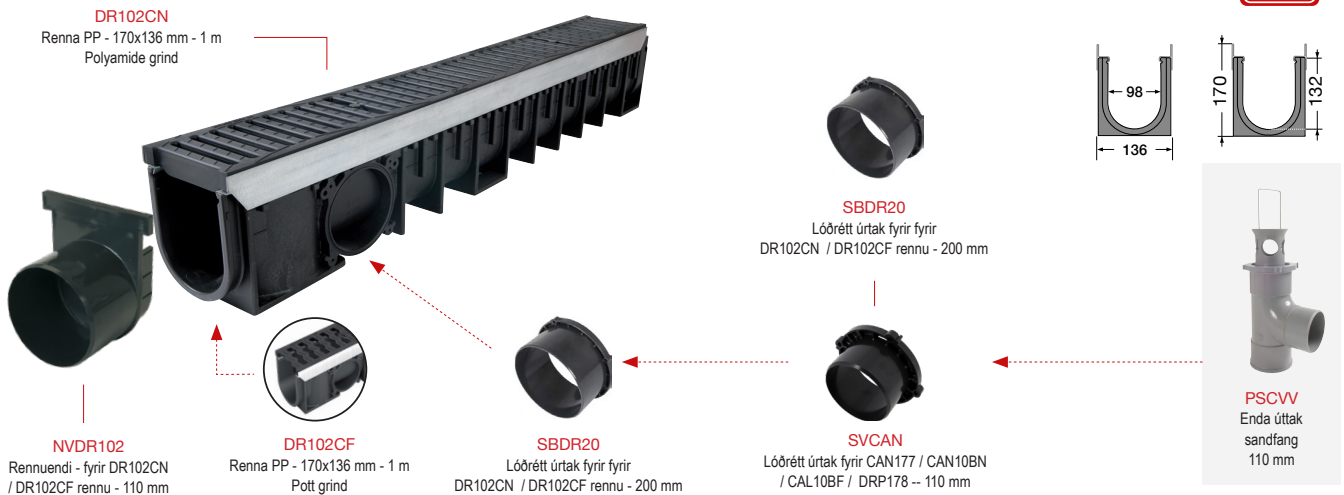
KENADRAIN®

CLASS C250 - Ætlað fyrir svæði með léttri bílaumferð

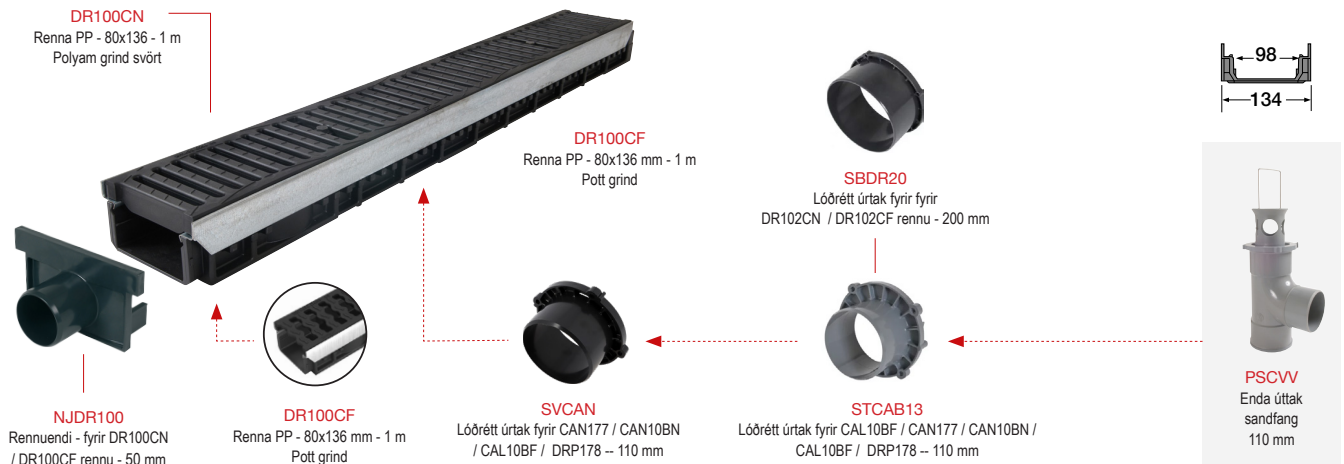
KENADRAIN®

CLASS E400 - Ætlað fyrir hraðbrautir, bílastæði og öll ökutæki.

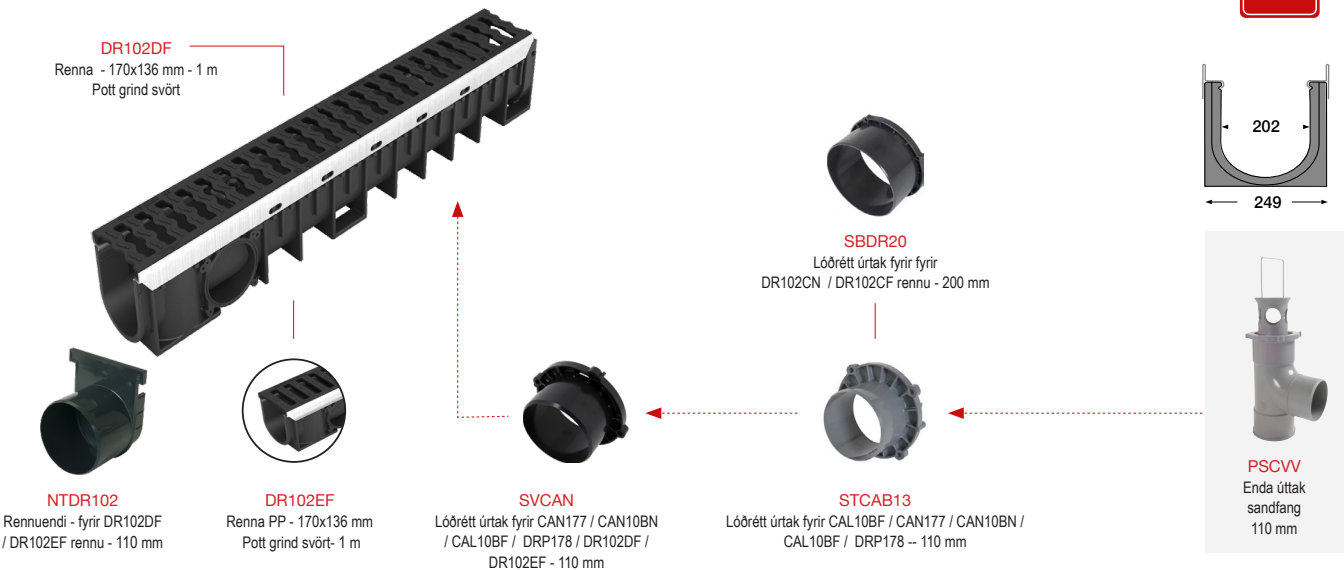
KENADRAIN®

CLASS E600 - Ætlað fyrir svæði með mikilli umferð, t.d. iðnaðarplön eða hafnarsvæði.

KENADRAIN®

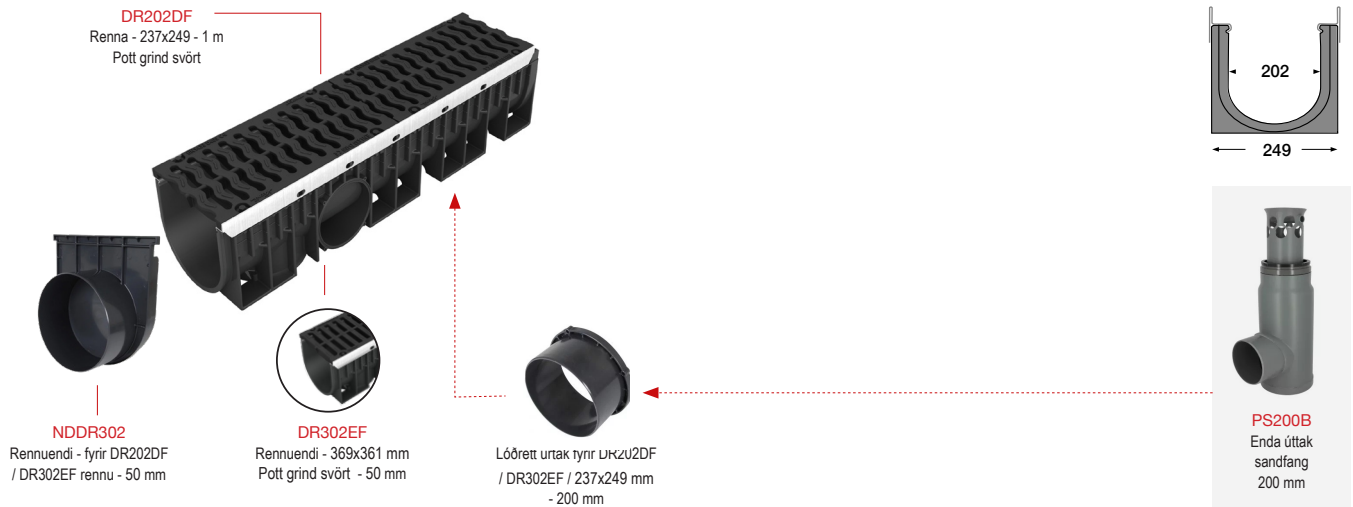

Margar gerðir og lausnir og einfalt í uppsetningu - Fellur vel inn í umhverfið - Sterkt og þolir mikila umferð á iðnaðarplönum

CONNECTO®



Fyrir einkabílastæði og garða



KENADRAIN®



Fyrir þéttbýli og opinbert svæði

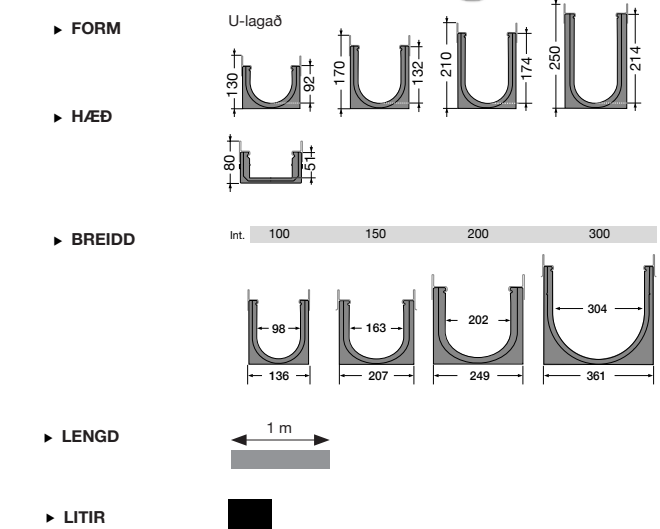
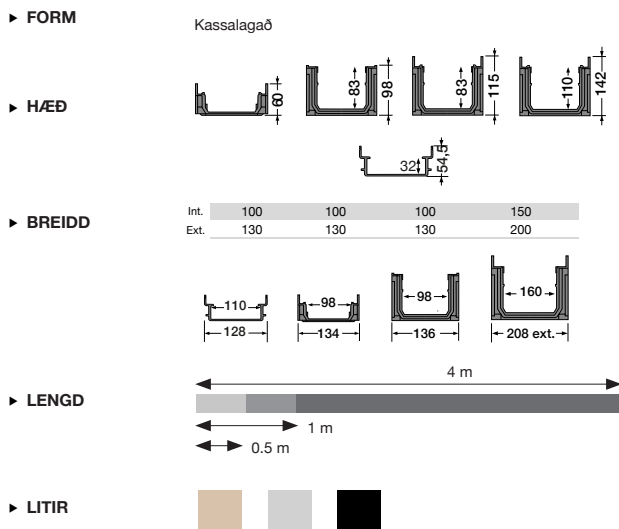
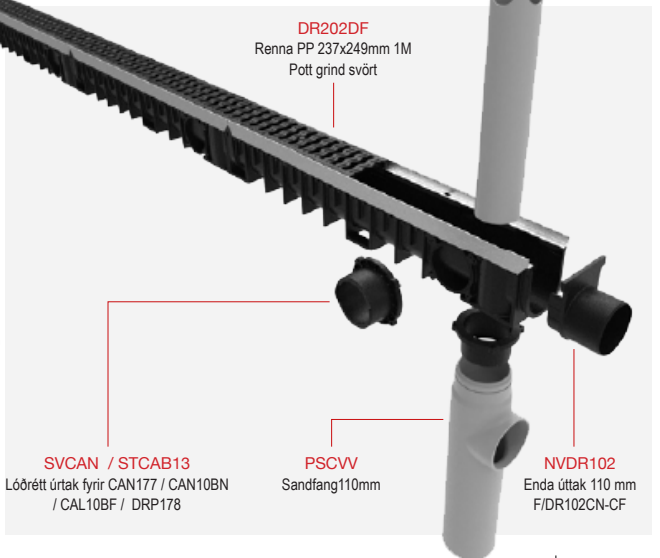

Niðurföll - líka fyrir þá sem þurfa lítið pláss

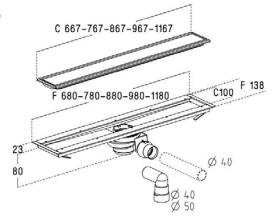
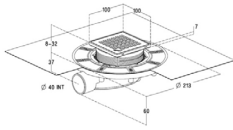

Niðurfall

Vörunúmer	Gerð	mm	Ø mm
SFH10ICEX	m/vatnslás	100x100	100
SFH15ICEX	m/vatnslás	150x150	100



DOCIA sturtuniðurfall

Vörunúmer	Gerð	lengd cm	l/min
SICANCFH70R	Sturtuniðurfall	70	26
SICANCFH80R	Sturtuniðurfall	80	26
SICANCFH90R	Sturtuniðurfall	90	26
SICANCFH100R	Sturtuniðurfall	100	26



Niðurfall

Vörunúmer	Gerð	mm	Ø mm
SK1110G	m/vatnslás - hvítt	100x100	40/50

Frárennslislagir og fittings fyrir vaska og vatnslás



Hné 87° M/N

Vörunúmer	Gerð	Litur	Ø
CF8B	frárennslí - M / N	Hvítt	32 mm
CH8B	frárennslí - M / N	Hvítt	40 mm
CJ8B	frárennslí - M / N	Hvítt	50 mm



Hné 87° M/M

Vörunúmer	Gerð	Litur	Ø
CF88B	frárennslíhné - M / M	Hvítt	32 mm
CH88B	frárennslíhné - M / M	Hvítt	40 mm
CJ88B	frárennslíhné - M / M	Hvítt	50 mm



Hné 45° M/N

Vörunúmer	Gerð	Litur	Ø
CF4B	frárennslíhné - M / N	Hvítt	32 mm
CH4B	frárennslíhné - M / N	Hvítt	40 mm
CJ4B	frárennslíhné - M / N	Hvítt	50 mm



Hné 45° M/M

Vörunúmer	Gerð	Litur	Ø
CF44B	frárennslíhné - M / M	Hvítt	32 mm
CH44B	frárennslíhné - M / M	Hvítt	40 mm
CJ44B	frárennslíhné - M / M	Hvítt	50 mm



Grein 87° - 30°

Vörunúmer	Gerð	Litur	Ø
TF188BL	frárennslí - M / M	Hvítt	32 mm
TH188BL	frárennslí - M / M	Hvítt	40 mm
TJ188BL	frárennslí - M / M	Hvítt	50 mm



Grein 45° - M/M

Vörunúmer	Gerð	Litur	Ø
BF144B	frárennslí 45° - M / M	Hvítt	32 mm
BH144B	frárennslí 45° - M / M	Hvítt	40 mm
BJ144B	frárennslí 45° - M / M	Hvítt	50 mm



Samtengi

Vörunúmer	Gerð	Litur	Ø
M2FB	frárennslí - samtengi	Hvítt	32 mm
M2HB	frárennslí - samtengi	Hvítt	40 mm
M2JB	frárennslí - samtengi	Hvítt	50 mm



Minnkun

Vörunúmer	Gerð	Litur	Ø
IHB	Frárennslí - Minnkun	Hvítt	40/32 mm
JB	Frárennslí - Minnkun	Hvítt	50/40 mm
JFB	Frárennslí - Minnkun	Hvítt	50/32 mm



Öndunarrör

Vörunúmer	Gerð	stærð Ø	Litur
TMA50B	Öndunarrör	100/125 mm	Hvítt



Vatnslás

Vörunúmer	Gerð	stærð Ø
0202073	Vatnslás 1 1/4	32 mm x L 250 mm
0202074	Vatnslás 1 1/4	40 mm x L 250 mm



Vatnslás

Vörunúmer	Gerð	stærð Ø
0202117	1 1/4 sem sparar pláss	32 mm 2x180 mm



Vatnslás

Vörunúmer	Gerð	stærð Ø
0201241	1 1/4 með ABS Crore	32 mm x 250 mm

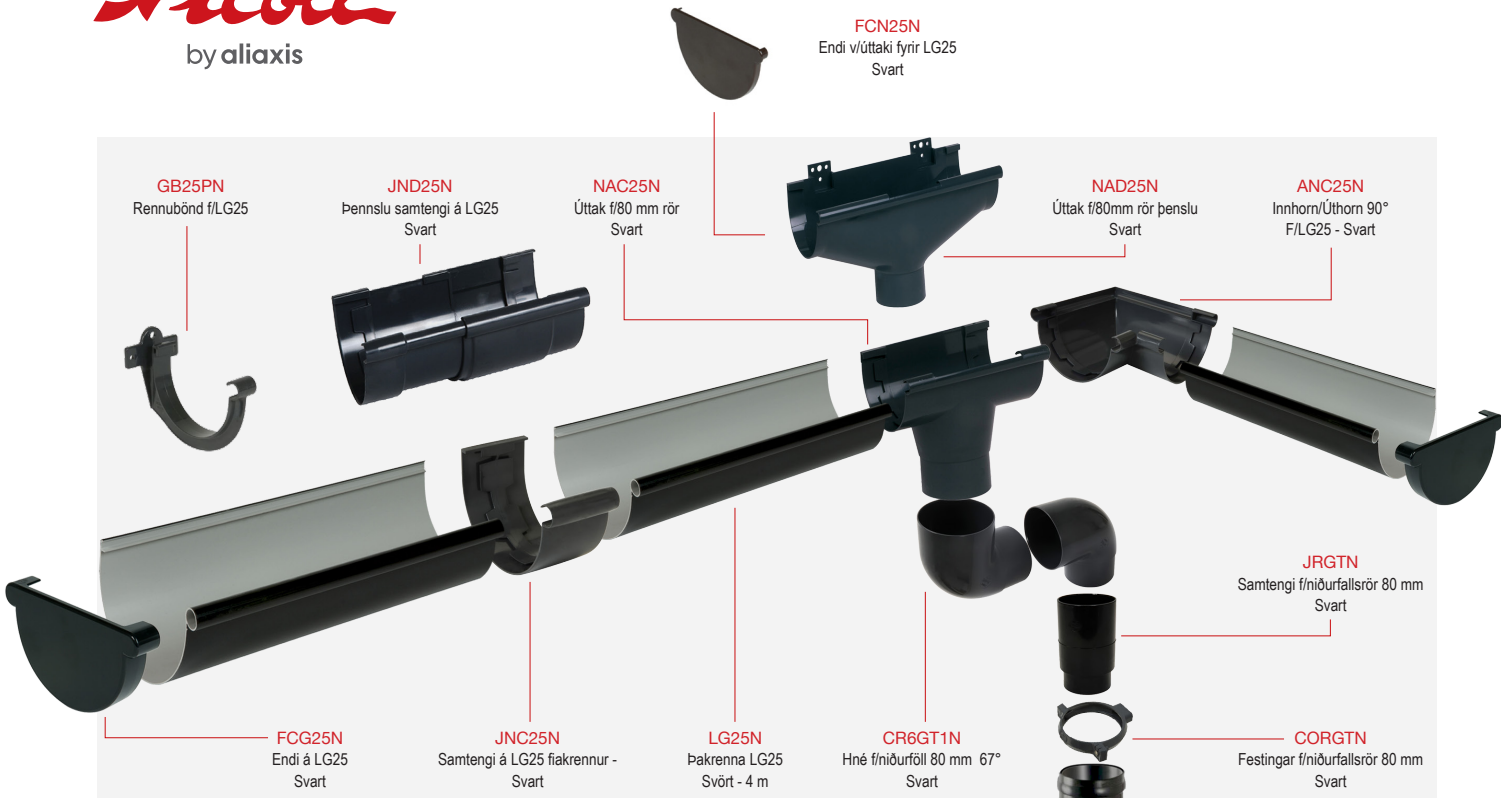

Helstu kostir TECHTAN®

- Það er mjög auðvelt í uppsetningu.
- Það er mjög veðurþolið með allt að 30 ára ábyrgð.
- Það er gert úr 100% endurvinnanlegum efnum.
- Það er höggþolnara en sambærilegar þakrennur.
- Það er blanda af pvc og titanium.
- Það hefur verið prófað við allar erfiðustu aðstæður!
(-40°til +60°c / Haglél og snjó / 55m/s vind / Útfjólubláageilsa)



Hvert rennuband
þolir 100 kg álag



TSON
Lim fyrir PVC 125.ml



PV4BO
Skrúfur f/festingar 40mm

TD803N
Niðurfallsrör 80 mm - 3 m
Svart

BR16GTN
Grein 67°30-80
Svart

Pakrennur



Uppsetning



Styrking



Litir

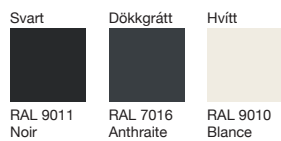

Sérpantaðir litir

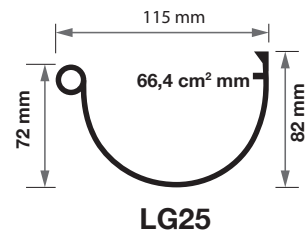
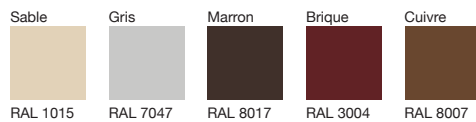

LG25



Þakrenna

Vörunúmer	Gerð	Lengd	Litur
LG25N	fyrir LG25	4 m	Svört
LG25B	fyrir LG25	4 m	Hvitt
LG25A	fyrir LG25	4 m	Dökkgrátt



Pennslu samtengi

Vörunúmer	Gerð	Litur
JND25N	fyrir LG25	Svört
JND25B	fyrir LG25	Hvitt
JND25A	fyrir LG25	Dökkgrátt



Úttak

Vörunúmer	Gerð	Litur
NAD25N	f/80 mm rör þenslu	Svart
NAD25B	f/80 mm rör þenslu	Hvitt
NAD25A	f/80 mm rör þenslu	Dökkgrátt



Úttak

Vörunúmer	Gerð	Litur
NAC25N	f/80 mm rör	Svart
NAC25B	f/80 mm rör	Hvitt
NAC25A	f/80 mm rör	Dökkgrátt



Endi

Vörunúmer	Gerð	Litur
FCG25N	fyrir LG25	Svört
FCG25B	fyrir LG25	Hvitt
FCG25A	fyrir LG25	Dökkgrátt



Endi v/úttaki

Vörunúmer	Gerð	Litur
FCN25N	fyrir LG25	Svört
FCN25B	fyrir LG25	Hvitt
FCN25A	fyrir LG25	Dökkgrátt



Samtengi

Vörunúmer	Gerð	Litur
JNC25N	fyrir LG25 þakrennur	Svört
JNC25B	fyrir LG25 þakrennur	Hvitt
JNC25A	fyrir LG25 þakrennur	Dökkgrátt



Innhorn / Úthorn 90°

Vörunúmer	Gerð	Litur
ANC25N	fyrir LG25	Svört
ANC25B	fyrir LG25	Hvitt
ANC25A	fyrir LG25	Dökkgrátt



Innhorn / Úthorn 135°

Vörunúmer	Gerð	Litur
ANC525N	fyrir LG25	Svört
ANC525B	fyrir LG25	Hvitt
ANC525A	fyrir LG25	Dökkgrátt



Niðurfallsrör

Vörunúmer	Gerð	stærð Ø	Litur
TD803N	niðurfallsrör - 3 m	80 mm	Svört
TD803B	niðurfallsrör - 3 m	80 mm	Hvitt
TD803A	niðurfallsrör - 3 m	80 mm	Dökkgrátt



Samtengi

Vörunúmer	Gerð	stærð Ø	Litur
JRGTN	fyrir niðurfallsrör	80 mm	Svört
JRGTB	fyrir niðurfallsrör	80 mm	Hvitt
JRGTA	fyrir niðurfallsrör	80 mm	Dökkgrátt



Grein 67°

Vörunúmer	Gerð	stærð Ø	Litur
BR16GTN	fyrir niðurfallsrör	30-80	Svört
BR16GTB	fyrir niðurfallsrör	30-80	Hvitt
BR16GTA	fyrir niðurfallsrör	30-80	Dökkgrátt



Hné 67°

Vörunúmer	Gerð	stærð Ø	Litur
CR6GT1N	fyrir niðurföll	80 mm	Svört
CR6GT1B	fyrir niðurföll	80 mm	Hvitt
CR6GT1A	fyrir niðurföll	80 mm	Dökkgrátt



Hné 87°

Vörunúmer	Gerð	stærð Ø	Litur
CR8GT1N	fyrir niðurföll	80 mm	Svört
CR8GT1B	fyrir niðurföll	80 mm	Hvitt
CR8GT1A	fyrir niðurföll	80 mm	Dökkgrátt



Festingar

Vörunúmer	Gerð	stærð Ø	Litur
CORGTN	fyrir niðurföll	80 mm	Svört
CORGTB	fyrir niðurföll	80 mm	Hvitt
CORGTA	fyrir niðurföll	80 mm	Dökkgrátt



Rennubönd

Vörunúmer	Gerð	Litur
GB25PN	fyrir LG25	Svört
GB25PB	fyrir LG25	Hvitt
GB25PA	fyrir LG25	Dökkgrátt



Skrúfur

Vörunúmer	Gerð	stærð
PV4BO	Skrúfur f/festingar	40 mm



Lím

Vörunúmer	Gerð	magn
TSON	Lím fyrir PVC	125 ml



WC kassi

Vörunúmer	Gerð	mm	Ø mm
WBS2P90	Happy suport	90 mm tenging	90



WC kassi

Vörunúmer	Gerð	Ø mm
0708105	Nicoll - undir glugga	110



WC kassi

Vörunúmer	Gerð	mm	Ø mm
WBS1PMU110	Solemur 110 mm tenging		110

Dura



WC skál

Vörunúmer	Gerð
5431	Dura SIRIUS salernisskál



Einstefnuventill

Vörunúmer	Gerð	stærð Ø	L/sek.
CEP3240	Einstefnuventill	32/40 mm	4 L/sek
CEP4050	Einstefnuventill	40/50 mm	11 L/sek
CEP100	Einstefnuventill	100/110 mm	43 L/sek



Skolventill

Vörunúmer	Gerð
0702124	Skolventill f/salerniskassa

Nicoll + Dura

Upphengt saleni og skál

Vörunúmer	Gerð
WC-sett	Nicoll + Dura WC kassi og skál



HAPPY SUPPORT - Salerniskassi

Nicoll
Happy
support

Hægt er að skoða myndbandin um Happy Support með QR kvótan



Mikið úrval af hnöppum

<p>REC</p> <p>Hvitt / Svart / Kremað / Króm</p>	<p>EVO</p> <p>Hvitt / Króm / Kremað</p>	<p>INFINITY</p> <p>Hvitt / Svart / Króm</p>
<p>SWING</p> <p>Hvitt / Svart / Kremað / Silfur</p>	<p>CAIMAN</p> <p>Hvitt / Króm / Matt króm</p>	<p>BOUTONS ROUNDS</p> <p>Hvitt / Króm</p>
<p>GOUTTE</p> <p>Hvitt / Svart / Króm</p>	<p>ROMA</p> <p>Hvitt / Svart / Kremað / Króm</p>	<p>MURANO</p> <p>Ryðfritt stál</p>

HLIÐ AÐ OFAN



Auðveldur aðgangur í vatskassan

POLYMER STÁL



Einföld uppsetning

FESTING



Auðvelt að stilla hæðina

ÚRVAL AF HNÖPPUM



Hraði og öryggi í uppsetningu

TENGI INN Í KASSANUM



Öruggi, engin leki

AUÐVELD TENGING



Rennandi krangi



Stillalegt rör

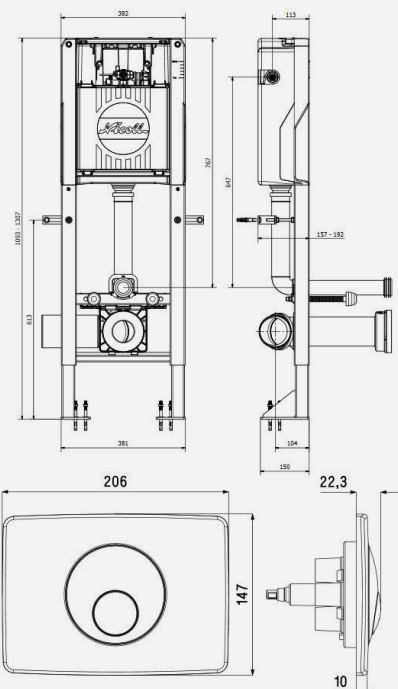



PBRECB



PBRECCM



PBRECN



PBREC2C



PBRECC

Hnappur - REC

Vörunúmer	Gerð	Litur
PBRECB	Rec	Hvitt
PBRECN	Rec	Svartur
PBRECCM	Rec	Matt króm
PBRECC	Rec	Glans króm
PBREC2C	Rec	Króm



0709315



0709317



PBRECCM



0709358

Hnappur - EVO

Vörunúmer	Gerð	Litur
0709315	Evo	Hvítur
0709316	Evo	Matt króm
0709317	Evo	Glans króm
PBRECCM	Evo	Matt króm



WPCINFS



WPCINFB



WPCINFC



WPCINFC

Hnappur - INFINITY

Vörunúmer	Gerð	Litur
WPCINFB	Infinity	Hvítur
WPCINFN	Infinity	Svartur
WPCINFC	Infinity	Matt króm
WPCINFS	Infinity	Svart matt króm



0709410



0709380



0709381



0709379

Hnappur - CAÍMAN

Vörunúmer	Gerð	Litur
0709410	Caíman	Matt+Glans króm
0709381	Caíman	Matt króm
0709380	Caíman	Glans króm
0709379	Caíman	Hvítur



0709186

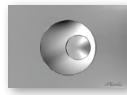

0709188



0709187



0709190



0709189

Hnappur - BUTTONS ROUNDS

Vörunúmer	Gerð	Litur
0709186	Buttons	Hvitt
0709187	Buttons	Matt króm
0709188	Buttons	Glans króm
0709189	Buttons	Króm+matt
0709190	Buttons	Matt+króm



0709141



0709140

Hnappur - GOUTTE

Vörunúmer	Gerð	Litur
0709141	Goutte	Matt króm
0709140	Goutte	Hvítur



WPCLAKB



WPCLAKC

Hnappur - LAKE

Vörunúmer	Gerð	Litur
WPCLAKB	Lake	Hvítur
WPCLAKC	Lake	Grárç



PBMURC2



WPCMUVBM

Hnappur - MURANO

Vörunúmer	Gerð	Litur
WPCMUVBM	Murano	Hvítur
PBMURC	Murano	Króm

Sérpantanir

DUO



WPCDUOB
WPCDUON
WPCDUOM

BRIGHT



WPCBRC
WPCBRBT
WPCBRBM
WPCBRNT

LED



WPCLED
Hægt að breytir litum

DROPLET



0709140
0709141
0709150

ROMA



WPCROIM



Taktu mynd af QR kóðanum og skoðuðu bæklingin í símanum



TENGIKRANAR



Tengikrani

Vörunúmer	Gerð	Ø
CQ4105	3-way	1/2x1/2x1/2"



Tengikrani

Vörunúmer	Gerð	Ø
NOV76MAC	Stuttur	1/2x3/8"



Tengikrani

Vörunúmer	Gerð	Ø
NOV88MAC	Langur	1/2x3/8"



Tengikrani

Vörunúmer	Gerð	Ø
COMB5MAC	Tvöfaldur	1/2x3/4x2/8"



Tengikrani

Vörunúmer	Gerð	Ø
728MN	Fyrir þvottavélur	1/2x3/4"



BLÖNDUNARTÆKI OG STÁLVASKAR

FYRIR OPINBERA STAÐI OG FYRIRTÆKI



DELABIE

FYRIR HEILSUGÆSLUNA

Tilvalinn fyrir heilsugæslustöðvar, elli- og hjúkrunarheimili, sjúkrahús og heilsugæslustöðvar

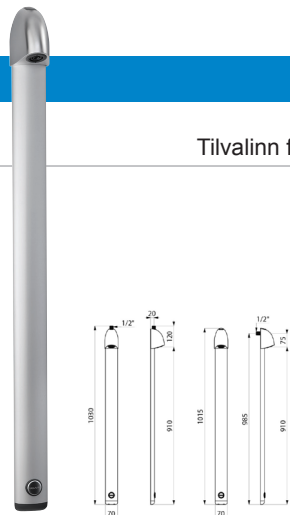

Sturtusett

Vörunúmer	Gerð
714700	SPORTING 2

Glansandi ál og safín króm áferð.

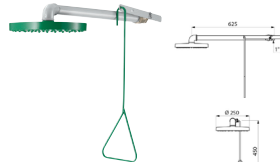

Öryggissturta

Vörunúmer	Gerð
9108	ÖRYGGISSTURTA

Öryggissturta á vegg með handvirkri stjörn



Augnskölun

Vörunúmer	Gerð
9102	AUGNSKÖLUN

Á vegg með handvirkri stjörn



Öryggissturta

Vörunúmer	Gerð
9203	ÖRYGGISSTURTA

Öryggissturta með augaskilun - samsett. Frístandandi.

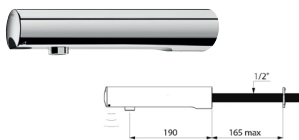

Veggfestur krani

Vörunúmer	Gerð
443516	TREMOMATIC 4

Rafstýrt veggfestur vatnskrani
Lithium 123 6V rafhlöður innbyggðar.
Rennslíð er stillt á 3 lpm við 3 bör, hægt að stilla frá 1,5 - 6 lpm.
Skynjar með innrauðu ljósi á enda stútsins.
Bakteríuþeftandi ryðfritt burstaðu stáli L. 190mm.
Fyrir uppsetningu á vegg.
Hentar fólki með skerta hreyfigetu.



Sturtusæti

Vörunúmer	Gerð
511930W	BE-LINE

Sturtusæti fyrir fatlað fólk eða hreyfihamlað fólk.
Sterkt sæti úr hástyrk fjölliðu.
5 faldir festingar.
Fylgir með ryðfriu stáli skúrúfum Ø 8 x 70mm á vegg.
Mál: 443 x 450 x 480 mm.
Stærð samantrotin: 87 x 541 mm.
Hámarksþyngt: 135 kg.

Handúði

Vörunúmer	Gerð
433010	HANDÚÐI - Svartur

Svartur handúði með tvær mismunandi úðara.
Pólyprópylen handfang með slípivörn.
Krómhúðuð stál.

Handúði

Vörunúmer	Gerð
433000	HANDÚÐI - Hvítur

Hvítur handúði með tvær mismunandi úðara.
Pólyprópylen handfang með slípivörn.
Krómhúðuð stál.

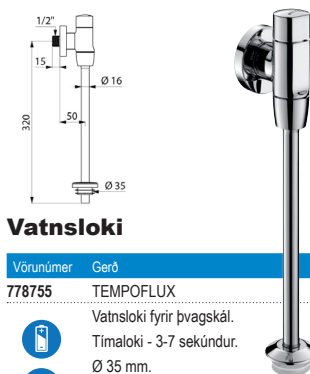

Vatnsloki

Vörunúmer	Gerð
778755	TEMPOFLUX

Vatnsloki fyrir þvagskál.
Tímaloki - 3-7 sekúndur.
Ø 35 mm.
Fyrir veggfestingar.

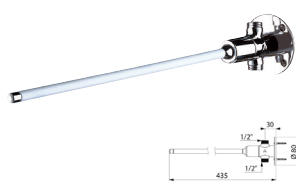

Hnéstýring

Vörunúmer	Gerð
735400	HNÉSTÝRING

Hnéstýrður vatnsloki

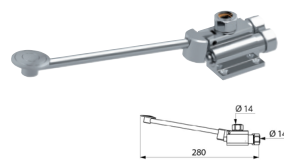

Fótstýring

Vörunúmer	Gerð
739000	FÓTSTÝRING

Fótstýrður vatnsloki



Vatnsloki

Vörunúmer	Gerð
479006	TEMPOMATIC 3

Vatnsloki fyrir þvagskál.
Rafren loki með rafhlöðu.
Fyrir veggfestingar.
Tímaloki - 3 sekúndur

VASKAR - HITASTILLIR - AUKAHLUTIR



Stálvaskar

Vörunúmer	Gerð
120650	QUADRA
	Stálvaskur á borð. Úr bakteríuþeftandi ryðfriju burstuðu stáli. Hálf innfeldur. Stærð: 380x380 mm.

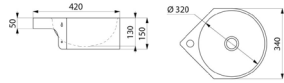

Stálvaskar

Vörunúmer	Gerð
121550	MINIMAL
	Stálvaskur í horn (90° horn) veggghengdur. Úr bakteríuþeftandi ryðfriju burstuðu stáli. Með miðjugat Ø 35 mm fyrir blöndunartæki. Innri þvermál skálar: 320 mm.

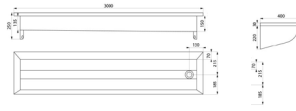
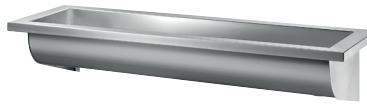

Stálvaskar

Vörunúmer	Gerð
120310	CANAL
	Úr bakteríuþeftandi ryðfriju burstuðu stáli. Veggghengt. Lengd: 1200-3000 mm.

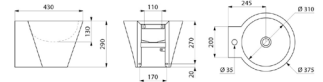

Stálsalerni

Vörunúmer	Gerð
121180	MINI BAILA
	Veggghengdur handlaug.
	Innra þvermál vaska: 310 mm.
	Úr bakteríuþeftandi ryðfriju burstuðu stáli - þykkt: 1 mm.
	Ávalar brúnir koma í veg fyrir meiðsl.
	Borað gat - Ø 35 mm.
	Fylgir með 1/2" úrgangi. Án yfirfalls.
	Þyngd: 4,1 kg.

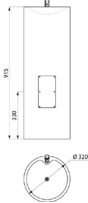

Drykkjabrunnur

Vörunúmer	Gerð
180100	ILHA
	Gólfstandandi drykkjafontur úr bakteríuþeftandi ryðfritt burstuðu stáli með innbyggðum krana. Hæð: 915 mm.

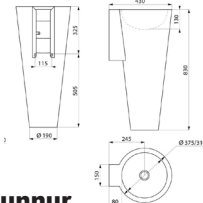

Drykkjabrunnur

Vörunúmer	Gerð
120172	BAILA
	Gólfstandandi drykkjafontur úr bakteríuþeftandi ryðfriju burstuðu stáli, með ávolum brúnum. Hæð: 830 mm.

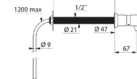

Sápuskammtari

Vörunúmer	Gerð
729150	SÁPUSKAMMTARI
	Veggghengdur sápuskammtari
	Krómhúðuð þrýstihnappur.
	90 mm.

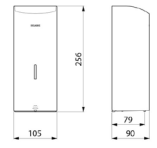

Sápuskammtari

Vörunúmer	Gerð
512066P	SÁPUSKAMMTARI
	Veggghengt, fyrir rafhlöður, 1 lítra.
	Ryðfritt stál.

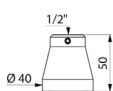

Sturtuhaus

Vörunúmer	Gerð
716000	GYM
	Lofffesting. Vatnssparnaður allt að 80%

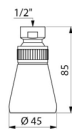

Sturtuhaus

Vörunúmer	Gerð
711000	GYM COMFORT
	Stíllanlegur sturtuhaus með rist. Lofffestingu - Ø 45 mm. Fyrir mjúkan og þægilegan úða.



Sigti

Vörunúmer	Gerð
921022.50P	SIGTI
	Sjómulaga sigti án rist.
	F22/100.
	Universal - alhliða



Flæðistillir

Vörunúmer	Gerð
927015.5P	FLÆÐISTILLIR
	Nippill 1/2x3/8 Króm með sæti FM1/2".
	10 lpm við 3 bör ± 10%.

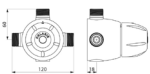

Hitastillir

Vörunúmer	Gerð
731002	PREMIX COMFORT
	Stór blandari fyrir 32°-42°C.
	Tímastillir.
	Hitavörn.
	Stöðugur hiti.

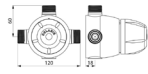

Hitastillir

Vörunúmer	Gerð
731052	PREMIX SECURITY
	Hitastillir fyrir blöndunartæki fyrir 34 - 60°C.
	Fyrir 1 til 2 blöndunar- eða sturtutæki

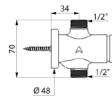

Hitastillir

Vörunúmer	Gerð
747800	TEMPOSOFT 2
	Vatnslöki fyrir sturtuna.
	Tímastillir.
	Mjúka og þægilegan úða.

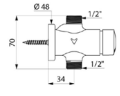

Hitastillir

Vörunúmer	Gerð
777800	TEMPOSOFT 2
	Vatnslöki fyrir þvagskál.
	Tímalöki - 3 sekúndur.

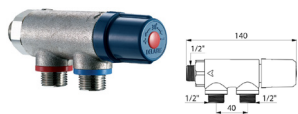

Hitastillir

Vörunúmer	Gerð
733015	PREMIX COMPACT
Hitastillir fyrir blöndunartæki fyrir 30 - 60°C.	
Fyrir 2 til 7 hreinlætisstöðvar (fer eftir flæðishraða).	
<i>Hitavörn gegn bruna:</i> stöðvað strax ef köldu eða heitu vatni bilar.	
Ráðlagt rennsli frá 5 - 20 lpm..	
M½".	

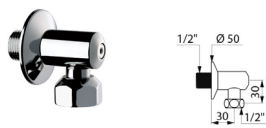

Vinkilkrani

Vörunúmer	Gerð
836015	TENGIKRANI
Vinkill union f/Tamposoft	
Krómhúðuð stál.	
MF 1/2".	
L.30 mm.	
H.30 mm.	

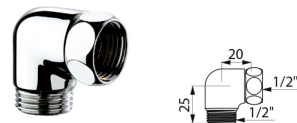

N-hné

Vörunúmer	Gerð
871015.2P	HNÉ
Krómhúðuð kopar.	
MF 1/2".	
L.20 mm, H.25 mm.	



Veggplatti

Vörunúmer	Gerð
824800	TEMPOFLUX
Veggplatti fyrir sturtuskammtara 3/4"	
4 skrófur.	
F12 x 1,5.	
4 mm þykkt	



Sturtuhaussíu

Vörunúmer	Gerð
820023	TENGI FYRIR STURTHAUS v/ 20051P.10P / 20250
Þrýstitingi M1/2" fyrir sturtuhausa	
Universal - alhlíða tengi	



Sturtuhaussíu

Vörunúmer	Gerð
820022	TENGI FYRIR STURTHAUS v/ 20050A.10P
Þrýstitingi F22/100 fyrir sturtuhausa	
Universal - alhlíða tengi	



Sturtuhaussíu

Vörunúmer	Gerð
820025	TENGI FYRIR STURTHAUS v/ 20050A.10P fyrir BIOFIL
Þrýstitingi M24/125 fyrir sturtuhausa	
Universal - alhlíða tengi	



Sturtuhaussíu

Vörunúmer	Gerð
820026	TENGI FYRIR STURTHAUS v/ 20051P.10P / 20250
Þrýstitingi M16.5x100 fyrir sturtuhausa	
Universal - alhlíða tengi	



Bakteríudrepandi síua

Vörunúmer	Gerð
20250	EINNOTA SÍUA með úða
Einnota bakteríudrepandi fyrir krana.	
BIOFIL sía með dauðhreinsað 0,1µm.	
Síunarfloitur: 1.400 cm².	
Síunarrennsli: 12 lpm við 3 bör	
Lengd hámarksnotkunar: 62 dagar eftir uppsetningu.	
Þyngd: 80g.	

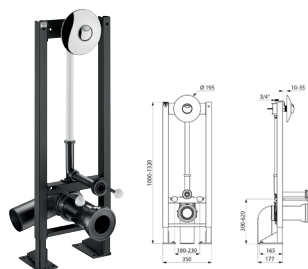

Salerniskassa

Vörunúmer	Gerð
578305-578222	TEMPOFIX 3
Grind fyrir salerniskassa.	
Hnappur fyrir 3L eða 6L á kassa	
10-35 mm á vegg.	
Auðvelt og fjótlegt að til uppsetningar.	

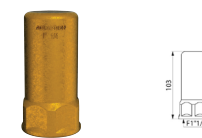

Hljóðdeyfir

Vörunúmer	Gerð
23033	HLJÓÐDEYFIR FYRIR VATN
Hljóðdeyfir með ryðfriju stáli	
Steyptum kopar.	
Dregur allt að 20 bör.	
F1 1/4", H. 103 mm.	

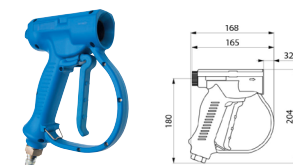

Vatnsbyssa

Vörunúmer	Gerð
433011	VATNSBYSSA
Höggþolið handúðari með stillalegum gikk.	
Mögulegt að læsa giknum í opinni stöðu.	
Hámarksþiti: 50°C.	
Hámarksþrýstingur: 12 bar.	

Fleiri aukahlutir fyrir **DELABIE** er hægt er að skoða á <https://loft.is> og það nýjasta hjá **DELABIE**



Rafmagnsbox

Vörunúmer	Gerð
495446BC	RAFMAGNSBOX
6V - 220-240 V - 50 Hz - IP65	

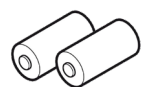

Rafhlaða f/stýribox

Vörunúmer	Gerð
990123	RAFHLAÐA
Rafhlaða Lithium 2x3V í stýribox 495446BVC	

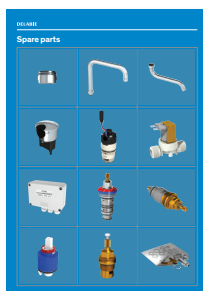

DELABIE

Bakteríudrepandi síur fyrir blöndunartæki

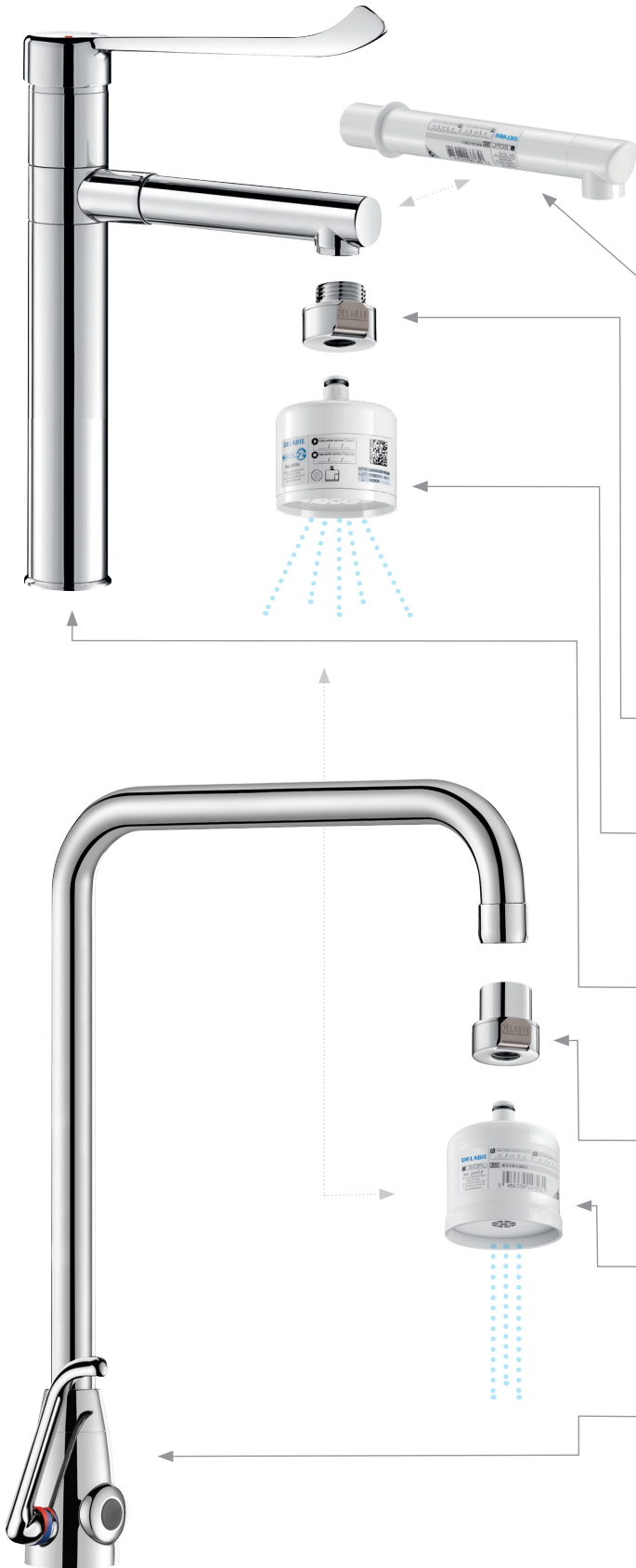

NÁNARI UPPLÝSINGAR

20040.10P

Bakteríudrepandi stútur - Einnota bakteríudrepandi stútur

Hægt skipta út BIOCLIP stúta í staðin venjulegan stút (engin þörf á sér verkfærum eða að skrúfa fyrir vatni)
Úr pólýetýlen plasti.
Síunarflötur: 1,200cm².
Hámarksþrýstingur 5 bör.
Lengd hámarksnotkunar: 62 dagar eftir uppsetningu.
Þyngd: 40g.

820122

Tengi fyrir blöndunartæki

v/ 20050A.10P - Þrýstítengi F22/100 fyrir blöndunartæki / Múffa Universal - alhliða tengi

20250

Bakteríudrepandi síua - Einnota síua með úða

BIOFIL síua með dauðhreinsað 0,1µm.
Síunarflötur: 1.400 cm². Síunarrennsli: 12 lpm við 3 bör
Lengd hámarksnotkunar: 62 dagar eftir uppsetningu.
Þyngd: 80g.

2870T1

Handlaugartæki - TEMPOMATIC MIX PRO - Rafrænt

Blöndunartæki á borð með háum (160 mm) - snúanlegum, stút sem er hægt að skipata út fyrir bakteríudrepandi stútur.
Rennsið takmarkaður við 5 lpm við 3 bör.
Bakteríuheftandi ryðfrítt burstaðu stáli F3/8".

820124

Tengi fyrir blöndunartæki

v/ 20051P.10P / 20250 - Þrýstítengi M1/2" fyrir blöndunartæki / Nippill Universal - alhliða tengi

20051P.10P

Bakteríudrepandi síua - Einnota síua með beinni bunu

BIOFIL síua með dauðhreinsað 0,1µm.
Síunarflötur: 1.400 cm². Síunarrennsli: 12 lpm við 3 bör
Lengd hámarksnotkunar: 62 dagar eftir uppsetningu.
Þyngd: 80g.

49525315

Handlaugartæki - TEMPOMATIC MIX PRO - Rafrænt

Meira hreinlæti: Engin handvirk snerting handlaugartæki hátt með yfirveflu fyrir frístandandi vask.



HITABLÁSARA

VÖRUHÚSIÐ - BÍLSKÚRINN - GRÓÐURHÚSIÐ - VERSLUNINA



VTS



Hitablásari Volcano EC

Vörunúmer	Gerð	mótor
1-4-0101-0455	Volcano VR Mini	EC 3-20 kW
1-4-0101-0442	Volcano VR1	EC 5-30 kW
1-4-0101-0443	Volcano VR2	EC 8-50 kW
1-4-0101-0444	Volcano VR3	EC 13-75 kW



Hitablásari Volcano AC

Vörunúmer	Gerð	mótor
1-4-0101-0445	Volcano VC Mini	AC 3-20 kW
1-4-0101-0446	Volcano VR1	AC 5-30 kW
1-4-0101-0447	Volcano VR2	AC 8-50 kW
1-4-0101-0448	Volcano VR3	AC 13-75 kW



Hitablásari Wing

Vörunúmer	Gerð	f/vatn	mótor
1-4-2801-0055	Wing / hvítt	f/vatn	EC motor L-1,0 m
1-4-2801-0056	Wing / hvítt	f/vatn	EC motor L-1,5 m
1-4-2801-0057	Wing / hvítt	f/vatn	EC motor L-2,0 m
1-4-2801-0309	Wing / svart	f/vatn	EC motor L-2,0 m



Hitaskynjari

Vörunúmer	Gerð
1-2-1205-0007	Hitaskynjari fyrir HMI stýringu



Hraðstýring

Vörunúmer	Gerð
1-4-0101-0438	Hraðstýring fyrir Volcano - AC-3 hrað
1-4-2801-0155	Hraðstýring fyrir Wing - EC-VR 0-1
1-4-2801-0157	Hraðstýring fyrir Volcano - VR 0-1



Festingar

Vörunúmer	Gerð
1-4-2801-0053	Festinga fyrir Wing hitablásara - 100
1-4-2801-0054	Festinga fyrir Wing hitablásara - 150/200

VOLCANO

	VR Mini	VR1	VR2	VR3	VR-D Mini	VR-D
AFKÖST Í KW FRÁ:	3-20 kW	5-30 kW	8-50 kW	13-75 kW	-	-
HÁMARKS HITABLÁSTUR:	2100 m³/h	5300 m³/h	4850 m³/h	5700 m³/h	2330 m³/h	6500 m³/h
LÁRÉTTUR HITI ALLT AÐ:	14 m	23 m	22 m	25 m	16 m	28 m
LÓDRÉTTUR HITI ALLT AÐ:	8 m	12 m	11 m	12 m	10 m	15 m

*0,5 m/s hámarks hitablástur



WING

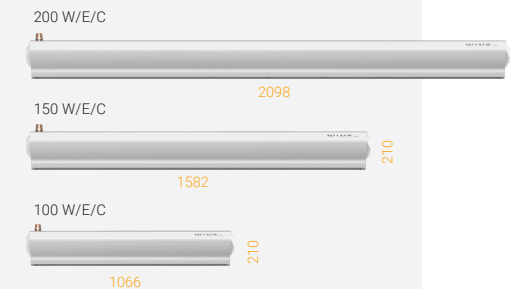

WING W

HITABLÁSARI FYRIR VATN:
AFKÖST Í KW FRÁ:
4 – 47 kW
HÁMARKS HITABLÁSTUR:
1850-4400 m³/h
HITADREIFING:
3,7 m

WING E

HITABLÁSARI FYRIR RAFMAGN:
AFKÖST Í KW FRÁ:
2 – 15 kW
HÁMARKS HITABLÁSTUR:
1850-4500 m³/h
HITADREIFING:
3,7 m

WING C

BLÁSARI MEÐ VIFTU:
HÁMARKS BLÁSTUR:
1950-4600 m³/h
HITADREIFING:
4 m



NÚTÍMALEGIR



NÚTÍMALEG HÖNNUN



HREINAR LÍNUR
Í LÖGUN OG LIT



LÉTT OG STERKT EFNI
OG EINFALT AÐ ÞRÍFA



SNJALLÆSING
Á HLÍF

NÝSKÖPUN



RIST SEM STJÓRNAR
LOFTI Á BESTAN HÁTT



STERKT VIFTUHÚS



VARMASKIPTI SEM
TRYGGIR RÉTT HITASTIG



HÁMARKS LOFTFLÆÐI
OG JÖFN DREIFING

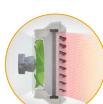

ORKUSPARNAÐUR



SKILVIRK VIFTUBLÖÐ
VEITA LITLA MÖTSTÖÐU



40% RAFMAGNS-
SPARNAÐUR

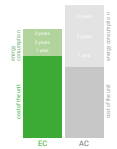

ÚR UMHVERFISVÆNU
EFNI



ORKUSPARANDI
EB MÓTÓR



WING PRO

IÐNAÐARHITABLÁSARAR

MEIRI KRAFTUR MEIRI HITI

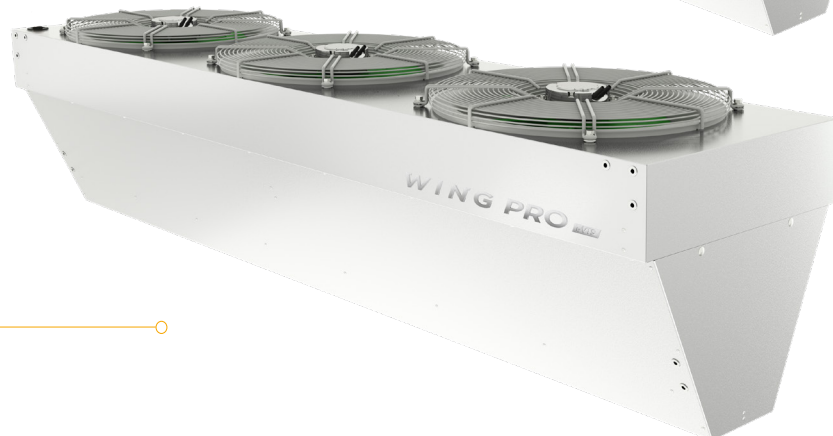
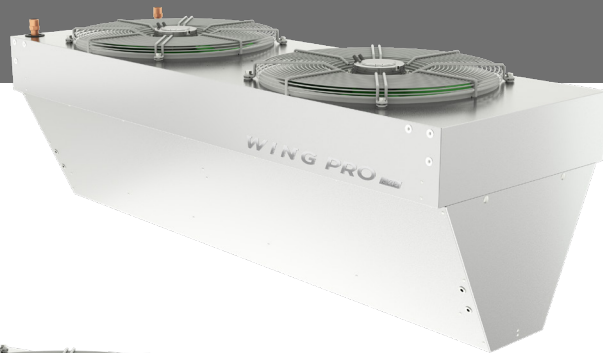

Breiður loftstraumur,
allt að **8 metrar**,
afkastageta allt að
88 kW



Vatnsorka



Taktu mynd af QR kóðanum og skoðaðu **Handbók 2024** í símanum



LOFT & RAFTÆKI
loft.is



Vatnsorka
vatnsorka.is



Hjallabrekka 1 - Dalbrekkumegin | 200 Kópavogur | S: 564 3000