

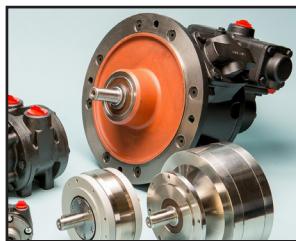

HANDBÓK 2024

Loftlagnir, fittings ofl.

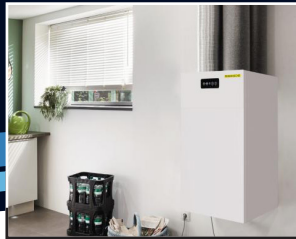
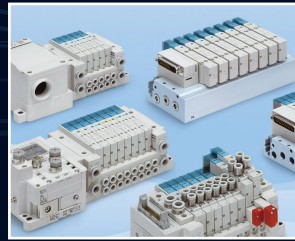
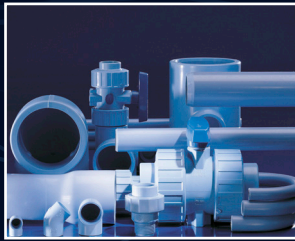

LOFT&RAFTÆKI | loft.is



Vatnsorka | vatnsorka.is



Hjallabrekka 1 - Dalbrekkumegin | 200 Kópavogur | S: 564 3000

Efniyfirlit

LOFTLAGNIR, FITTINGS OFL.

LOFTLAGNIR	Byrgjar	bis.
Girair	GIRPI	5
Rör	GIRPI	6
Fittings	GIRPI	6
Aukahlutir	GIRPI	9
Kaldsuða	GIRPI	10
Loftlagdir og tengi	John Geust	11
Loftfittings	John Geust	12
Rör og loftslöngur	John Geust	13
Neysluvatnslagdir	John Geust	13
Fittings úr plasti - Þrýsta og smella	John Geust	13
Fittings og rör fyrir neysluvatn	John Geust	14

LOFTLOKAR

SY lokar	SMC	17
Loftlokar	SMC	19
Handlokar	SMC	19
Síur - Mjúkstartlokar	SMC	21
Fínsía - Óliúglös - Smurtæki	SMC	23
Þrýstijafnarar - Filter	SMC	23
Tjakkar	SMC	24
Aukahluti	SMC	25-26
Loftlokar	CAMOZZI	27
Handstýring	CAMOZZI	28
Rafstýring	CAMOZZI	29
Fittings	CAMOZZI	30
Tjakkar	CAMOZZI	35
Verkfæri	CAMOZZI	35
Lofttjakkar	INOX	35
Loftrótor - ryðfrír / plast	PRISMA	36

LOFTMÓTORAR

Loftmótorar	GLOBE	36
Loft- og rafmótorar	Valpes	39
Segulspóla	Rotork	42
Segul- og sætislokar	M&M	42

LOFTHREINSUBÚNAÐUR

Loftskiptikerfið	FRÄNKISCHE	43
------------------------	-------------------------	----

LOFTPRESSUR

Skrúfupressur	POWER SYSTEM	54
Skrúfupressur	NUAIR	55
Mercury - Sirio - Seltex - Silair	NUAIR	55

Hugmynd um uppsetningu fyrir þrýstiloftskerfi3

KÆLIPURRKARI

Kælipurrrakar -	OMI	56
Kælipurrrakar -	BEKO	56

LOFTTANKAR

Lofttankar -	SICC	57
Tæknilegar upplýsinga	SICC	57

Hugmynd um uppsetningu fyrir þrýstiloftskerfi

SLÖNGUKEFLI OG SLÖNGUR

Slöngukefli	Sigmat	58
Slöngur	Sigmat	58

Seguldælur	DEBEM	58
-------------------------	--------------------	----

SÍUR

Síur og olíuskiljur	NOITECH	59
Síur og olíuskiljur	SOTRAS	59

FESTINGAKERFI

Brautir og festingar	MÜPRO	3
MPC - galvaniserað	3
Brautir og festingar	MÜPRO	67
Ryðfrítt - V2A - V4A	67
Vibringsvarnir	MÜPRO	69
Merkiplöturi	MÜPRO	69
Aukahluti	MÜPRO	69

VERKFÆRI

Purrborun	MAXIMA	71
-----------------	---------------------	----



Loftlagnir

GIRAIR





Rör - 4 m.

Vörunúmer	Gerð	Ø stærð
TUBGA16	Rör	16
TUBGA20	Rör	20
TUBGA25	Rör - max 12,5 bar	25
TUBGA32	Rör	32
TUBGA40	Rör - max 12,5 bar	40
TUBGA50	Rör	50
TUBGA63	Rör	63
TUBGA75	Rör	75
TUBGA90	Rör	90
TUBGA110	Rör	110



Hné 90°

Vörunúmer	Gerð	Ø stærð
GA4M16	Hné 90°	16
GA4M20	Hné 90°	20
GA4M25	Hné 90°	25
GA4M32	Hné 90°	32
GA4M40	Hné 90°	40
GA4M50	Hné 90°	50
GA4M63	Hné 90°	63
GA4M75	Hné 90°	75
GA4M90	Hné 90°	90
GA4M110	Hné 90°	110



Hné 45°

Vörunúmer	Gerð	Ø stærð
GA8M16	Hné 45°	16
GA8M20	Hné 45°	20
GA8M25	Hné 45°	25
GA8M32	Hné 45°	32
GA8M40	Hné 45°	40
GA8M50	Hné 45°	50
GA8M63	Hné 45°	63
GA8M75	Hné 45°	75
GA8M90	Hné 45°	90
GA8M110	Hné 45°	110



Té tengi

Vörunúmer	Gerð	Ø stærð
GATE16	Té tengi	16
GATE20	Té tengi	20
GATE25	Té tengi	25
GATE32	Té tengi	32
GATE40	Té tengi	40
GATE50	Té tengi	50
GATE63	Té tengi	63
GATE75	Té tengi	75
GATE90	Té tengi	90
GATE110	Té tengi	110



Té tengi

Vörunúmer	Gerð	Ø stærð
GATR2016	Té tengi	20/16
GATR2520	Té tengi	25/20
GATR3220	Té tengi	32/20
GATR3225	Té tengi	32/25
GATR4020	Té tengi	40/20
GATR4025	Té tengi	40/25
GATR4032	Té tengi	40/32
GATR5025	Té tengi	50/25
GATR5032	Té tengi	50/32
GATR5040	Té tengi	50/40
GATR6325	Té tengi	63/25
GATR6332	Té tengi	63/32
GATR6340	Té tengi	63/40
GATR7525	Té tengi	75/25
GATR7532	Té tengi	75/32
GATR7540	Té tengi	75/40
GATR9025	Té tengi	90/25
GATR9032	Té tengi	90/32
GATR9040	Té tengi	90/40
GATR1132	Té tengi	110/32
GATR1140	Té tengi	110/40
GATR1150	Té tengi	110/50



Vatnslás

Vörunúmer	Gerð	Ø stærð
GA2C16	Vatnslás	16
GA2C20	Vatnslás	20
GA2C25	Vatnslás	25
GA2C32	Vatnslás	32



Samtengi

Vörunúmer	Gerð	Ø stærð
GAMA16	Samtengi	16
GAMA20	Samtengi	20
GAMA25	Samtengi	25
GAMA32	Samtengi	32
GAMA40	Samtengi	40
GAMA50	Samtengi	50
GAMA63	Samtengi	63
GAMA75	Samtengi	75
GAMA90	Samtengi	90
GAMA110	Samtengi	110



Minnkun

Vörunúmer	Gerð	Ø stærð
GARD2516	Minnkun	25/16
GARD3220	Minnkun	32/20
GARD4025	Minnkun	40/25
GARD5032	Minnkun	50/32
GARD6325	Minnkun	63/25
GARD6332	Minnkun	63/32
GARD6340	Minnkun	63/40
GARD7532	Minnkun	75/32
GARD7550	Minnkun	75/50
GARD9050	Minnkun	90/50
GARD9063	Minnkun	90/63
GARD1150	Minnkun	110/50
GARD1163	Minnkun	110/63



Hné - langt

Vörunúmer	Gerð	Ø stærð
GA4C50	Hné - langt	50
GA4C63	Hné - langt	63
GA4C75	Hné - langt	75
GA4C90	Hné - langt	90
GA4C110	Hné - langt	110



Nippiltengi

Vörunúmer	Gerð	Ø stærð
GAEBL16	16/20 x 1/2"	16
GAEBL25	25/32 x 1"	25



Nippiltengi

Vörunúmer	Gerð	Ø stærð
GAEAL16		20 x 3/8"
GAEAL20		20/25 x 1/2"
GAEAL25		25/32 x 3/4"
GAEAL32		32/40 x 1"
GAEAL40		40/50 x 1 1/4"
GAEAL50		50/63 x 1 1/2"
GAEAL63		63/75 x 2"



Lok

Vörunúmer	Gerð	Ø stærð
GABO16	Lok	16
GABO20	Lok	20
GABO25	Lok	25
GABO32	Lok	32
GABO40	Lok	40
GABO50	Lok	50
GABO63	Lok	63
GABO75	Lok	75
GABO90	Lok	90
GABO110	Lok	110



Minnkun

Vörunúmer	Gerð	Ø stærð
GARS20	Minnkun	20/16
GARS25	Minnkun	25/20
GARS32	Minnkun	32/25
GARS40	Minnkun	40/32
GARS50	Minnkun	50/40
GARS63	Minnkun	63/50
GARS75	Minnkun	75/63
GARS90	Minnkun	90/75
GARS110	Minnkun	110/90



Múffutengi

Vörunúmer	Gerð	Ø stærð
GAMM16	Nippiltengi	16 x 3/8"
GAMM20	Nippiltengi	20 x 1/2"
GAMM25	Nippiltengi	25 x 3/4"
GAMM32	Nippiltengi	32 x 1"
GAMM40	Nippiltengi	40 x 1 1/4"
GAMM50	Nippiltengi	50 x 1 1/2"
GAMM63	Nippiltengi	63 x 2"



Múffutengi

Vörunúmer	Gerð	Ø stærð
GAMML16	Múffutengi	16/20 x 3/8"
GAMML20	Múffutengi	20/25 x 1/2"
GAMML25	Múffutengi	25/32 x 3/4"
GAMML32	Múffutengi	32/40 x 1"
GAMML40	Múffutengi	40/50 x 1 1/4"
GAMML50	Múffutengi	50/63 x 1 1/2"
GAMML63	Múffutengi	63/75 x 2"



Nippiltengi

Vörunúmer	Gerð	Ø stærð
GAEA16	Nippiltengi	16 x 3/8"
GAEA20	Nippiltengi	20 x 1/2"
GAEA25	Nippiltengi	25 x 3/4"
GAEA32	Nippiltengi	32 x 1"
GAEA40	Nippiltengi	40 x 1 1/4"
GAEA50	Nippiltengi	50 x 1 1/2"
GAEA63	Nippiltengi	63 x 2"
GAEA75	Nippiltengi	75 x 2 1/2"



Nippiltengi

Vörunúmer	Gerð	Ø stærð
GAEB16	Nippiltengi	16 x 1/2"
GAEB20	Nippiltengi	20 x 3/4"
GAEB25	Nippiltengi	25 x 1"
GAEB32	Nippiltengi	32 x 1 1/4"
GAEB40	Nippiltengi	40 x 1 1/2"
GAEB50	Nippiltengi	50 x 2"

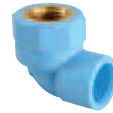

Múffuhné

Vörunúmer	Gerð	Ø stærð
GA4GL20	Múffuhné	20 x 1/2"

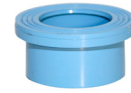

Flange

Vörunúmer	Gerð	Ø stærð
GACS50	Flange	50
GACS63	Flange	63
GACS75	Flange	75
GACS90	Flange	90
GACS110	Flange	110



Té m/gengju

Vörunúmer	Gerð	Ø stærð
GATG1612	Té	16 x 1/2"
GATG2012	Té	20 x 1/2"
GATG2534	Té	25 x 3/4"



Hné m/gengju

Vörunúmer	Gerð	Ø stærð
GA4G16	Hné m/gengju	16 x 3/8"
GA4G20	Hné m/gengju	20 x 1/2"
GA4G25	Hné m/gengju	25 x 3/4"



Union

Vörunúmer	Gerð	Ø stærð
GA3F/P16	Union	16 x 3/8"
GA3F/P20	Union	20 x 1/2"
GA3F/P25	Union	25 x 3/4"
GA3F/P32	Union	32 x 1"
GA3F/P40	Union	40 x 1 1/4"
GA3F/P50	Union	50 x 1 1/2"
GA3F/P63	Union	63 x 2"



Union

Vörunúmer	Gerð	Ø stærð
GA3P16	Union	16
GA3P20	Union	20
GA3P25	Union	25
GA3P32	Union	32
GA3P40	Union	40
GA3P50	Union	50
GA3P63	Union	63



Vegghné

Vörunúmer	Gerð	Ø stærð
GAAP16	Vegghné	1/2" x 3/8"
GAAP20	Vegghné	3/4" x 1/2"
GAAP25	Vegghné	1" x 3/4"



Union

Vörunúmer	Gerð	Ø stærð
GA3G/L16	Union	16 x 3/8"
GA3G/L20	Union	20 x 1/2"
GA3G/L25	Union	25 x 3/4"
GA3G/L32	Union	32 x 1"
GA3G/L40	Union	40 x 1 1/4"
GA3G/L50	Union	50 x 1 1/2"
GA3G/L63	Union	63 x 2"



Union

Vörunúmer	Gerð	Ø stærð
GA3F/L16	Union	16 x 3/8"
GA3F/L20	Union	20 x 1/2"
GA3F/L25	Union	25 x 3/4"
GA3F/L32	Union	32 x 1"
GA3F/L40	Union	40 x 1 1/4"
GA3F/L50	Union	50 x 1 1/2"
GA3F/L63	Union	63 x 2"



Union

Vörunúmer	Gerð	Ø stærð
GA3F/L16	Union	16 x 3/8"
GA3F/L20	Union	20 x 1/2"
GA3F/L25	Union	25 x 3/4"
GA3F/L32	Union	32 x 1"
GA3F/L40	Union	40 x 1 1/4"
GA3F/L50	Union	50 x 1 1/2"
GA3F/L63	Union	63 x 2"



Loki

Vörunúmer	Gerð	Ø stærð
GA2MBE16	Loki	16
GA2MBE20	Loki	20
GA2MBE25	Loki	25
GA2MBE32	Loki	32
GA2MBE40	Loki	40
GA2MBE50	Loki	50
GA2MBE63	Loki	63



Loki

Vörunúmer	Gerð	Ø stærð
GA2MFE75	Loki	75
GA2MFE90	Loki	90
GA2MFE11	Loki	110



Veggplatti

Vörunúmer	Gerð	Ø stærð
GAAP12G2	Veggplatti 1/2"	2x1/2
GAAP34G3	Veggplatti 3/4"	3x1/2



Veggplatti

Vörunúmer	Gerð	Ø stærð
GAAP12G4	1/2"	4x1/2
GAAP34G4	3/4"	4x1/2
GAAP12G4P	1/2" með dreni	4x1/2
GAAP34G4P	1/2" með dreni	4x1/2



Primer - Hreinsir

Vörunúmer	Gerð
CLEANER+	1 l.



Lím

Vörunúmer	Gerð	Magn
Gafix	p	250 ml.
Gafix	b	1 l.

AUKAHLUTIR



Rörafestingar

Vörunúmer	Gerð	Ø stærð
HCKC25/8	25/8	25
HCKC32/8	32/8	32
HCKC40/8	40/8	40
HCKC50/8	50/8	50
HCKC63/8	63/8	63
HCKC75/8	75/8	75
HCKC90/8	90/8	90
HCKC110/8	110/8	110
HCKC125/8	125/8	125
HCKC160/8	160/8	160



Rörafestingar

Vörunúmer	Gerð	Ø stærð
HCKCP25/5	25/5	25



Rörafestingar

Vörunúmer	Gerð	Ø stærð
HCK16/8	16/8 - M8	16
HCK 20/8	20/8 - M8	20



Rörafestingar

Vörunúmer	Gerð	Ø stærð
HCKP16/5	16/5	16
HCKP 20/5	20/5	20



Flange tengi

Vörunúmer	Gerð	Ø stærð
BPA40	50 x 40	40
BPA50	63 x 50	50
BPA60	63 x 60	60
BPA65	75 x 60	65
BPA80	90 x 80	80
BPA100	110 x 100	100
BPA125	125 x 125	125
BPA140	140 x 125	140



Flans í loka HTA®

Vörunúmer	Gerð	Ø stærð
COLVHCEP16		16
COLVHCEP20		20
COLVHCEP25		25
COLVHCEP32		32
COLVHCEP40		40
COLVHCEP50		50
COLVHCEP63		63



Flans í loka GIRAIR®

Vörunúmer	Gerð	Ø stærð
COLGA2MBE16		16
COLGA2MBE20		20
COLGA2MBE25		25
COLGA2MBE32		32
COLGA2MBE40		40
COLGA2MBE50		50
COLGA2MBE63		63



Flans í loka KRYOCLIM®

Vörunúmer	Gerð	Ø stærð
COLVFCEP20		20
COLVFCEP25		25
COLVFCEP32		32
COLVFCEP40		40
COLVFCEP50		50
COLVFCEP63		63



Flange tengi

Vörunúmer	Gerð	Ø stærð
BVR25	32 x 25	25
BVR32B	40 x 32	32
BVR40B	50 x 40	40



Ró fyrir loka HTA®

Vörunúmer	Gerð	Ø stærð
ECVHCEP1620		16
ECVHCEP1620		20
ECRVHCEP25		25
ECRVHCEP32		32
ECRVHCEP40		40
ECRVHCEP50		50
ECRVHCEP63		63



Ró fyrir loka GIRAIR®

Vörunúmer	Gerð	Ø stærð
ECGA2MBE1620		16
ECGA2MBE1620		20
ECRGA2MBE25		25
ECRGA2MBE32		32
ECRGA2MBE40		40
ECRGA2MBE50		50
ECRGA2MBE63		63



Ró fyrir loka KRYOCLIM®

Vörunúmer	Gerð	Ø stærð
ECRVFCEP20		20
ECRVFCEP25		25
ECRVFCEP32		32
ECRVFCEP40		40
ECRVFCEP50		50
ECRVFCEP63		63



Hækkun

Vörunúmer	Ø stærð
CALE2563	25-63

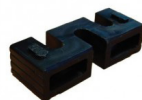

Hækkun

Vörunúmer	Ø stærð
CALE75110	75-110

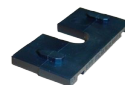

Hækkun

Vörunúmer	Ø stærð
CALE2563	25-63



Hækkun

Vörunúmer	Ø stærð
CALE1220	16-20



Röraskeri

Vörunúmer	Gerð	Ø stærð
CT1240R	Röraskeri	12 til 40 mm
CT1263R	Röraskeri	16 til 63 mm



MÜPRO röraskeri

Vörunúmer	Gerð	Ø stærð
115164	Röraskeri	6 til 67 mm



Yddari

Vörunúmer	Gerð	Ø stærð
CONE50U	Yddari	allt að 50 mm



MGF yddari

Vörunúmer	Gerð	Ø stærð
922983	Yddari	25 til 168 mm
922982	Hnífbíð	fyrir yddara

Leiðbeiningar fyrir

KALDSUÐU

Munið að velja rétta límið

Kalduða - einfalt og fljótlegt

 Skannaðu QR kóðanum og skoðu myndmyndband um **kalduði** í símanum

SKREF FYRIR SKREF



Skerið

Notið rörskera til að hafa skurðinn hreinan og beinan.

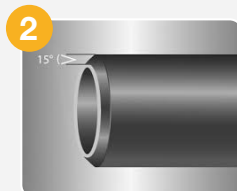

Yddið

Yddið rörið með yddara (CONE50U). Yddarinn jafnar dreifingu límsins.



Hreinsið

Hreinsið vel tengistykkin og rörin sem á að líma, með CLEANER+. Notið hreinan, mjúkan klút.



Berið lím á báða fleti

Berið lím á báða fleti, 4 til 8 sinnum.



Þrýstið saman

Þrýstið strax saman og haldið í 5 sek. án þess að snúa.



Loftlagnir og tengi

LOFTLAGNIR - NEYSLUVATNSLAGNIR - FITTINGS



John Guest

Múffutengi

Vörunúmer	Gerð	Ø (mm)	*
CM320616E	Múffutengi	6 mm	3/4"
CM320816E	Múffutengi	8 mm	3/4"
CM321014E	Múffutengi	10 mm	1/2"
CM321216E	Múffutengi	12 mm	3/4"

Múffutengi

Vörunúmer	Gerð	Ø (mm)	*
PM450411E		4 mm	1/8"
PM450611E		6 mm	1/8"
PM450612E		6 mm	1/4"
PM450812E		8 mm	1/4"
PM450813E		8 mm	3/8"
PM451015FE		10 mm	5/8"
PM451215FE		12 mm	5/8"

Minnkun

Vörunúmer	Gerð	Ø (mm)
PM060604E	Minnkun	6 mm - 4 mm
PM060804E	Minnkun	8 mm - 4 mm
PM060806E	Minnkun	8 mm - 6 mm
PM061006E	Minnkun	10 mm - 6 mm
PM061008E	Minnkun	10 mm - 8 mm
PM061208E	Minnkun	12 mm - 8 mm
PM061210E	Minnkun	12 mm - 10 mm
PM061510E	Minnkun	15 mm - 10 mm
PM061512E	Minnkun	15 mm - 12 mm
PM061815E	Minnkun	18 mm - 15 mm
PM062215E	Minnkun	22 mm - 15 mm
PM062218E	Minnkun	22 mm - 18 mm
PM062815E	Minnkun	28 mm - 15 mm
PM062822E	Minnkun	28 mm - 22 mm

Slöngustútur

Vörunúmer	Gerð	Ø (mm)
PM250604E	Plasttengi	6 mm - 4 mm
PM250806E	Plasttengi	8 mm - 6 mm
PM251008E	Plasttengi	10 mm - 8 mm

Y tengi

Vörunúmer	Gerð	Ø (mm)
RM2306E	Y tengi	6 mm
RM2308E	Y tengi	8 mm
PM2310E	Y tengi	10 mm

Nippiltengi

Vörunúmer	Gerð	Ø (mm)	*
PM010411E	Nippiltengi	4 mm	1/8"
PM010412E	Nippiltengi	4 mm	1/4"
PM010611E	Nippiltengi	6 mm	1/8"
PM010612E	Nippiltengi	6 mm	1/4"
PM010811E	Nippiltengi	8 mm	1/8"
PM010812E	Nippiltengi	8 mm	1/4"
PM010813E	Nippiltengi	8 mm	3/8"
PM011012E	Nippiltengi	10 mm	1/4"
PM011013E	Nippiltengi	10 mm	3/8"
PM011014E	Nippiltengi	10 mm	1/2"
PM011213E	Nippiltengi	12 mm	3/8"
PM011214E	Nippiltengi	12 mm	1/2"
PM011513E	Nippiltengi	15 mm	3/8"
PM011514E	Nippiltengi	15 mm	1/2"
PM011516E	Nippiltengi	15 mm	3/4"
PM011814E	Nippiltengi	18 mm	1/2"
PM012216E	Nippiltengi	22 mm	3/4"
PM012818E	Nippiltengi	28 mm	1"

Té tengi

Vörunúmer	Gerð	Ø (mm)
PM0204E	Tétengi	4 mm
PM0206E	Tétengi	6 mm
PM0208E	Tétengi	8 mm
PM0210E	Tétengi	10 mm
PM0212E	Tétengi	12 mm
PM0215E	Tétengi	15 mm
PM0218E	Tétengi	18 mm
PM0222E	Tétengi	22 mm
PM0228E	Tétengi	28 mm

Té tengi

Vörunúmer	Gerð	Ø (mm)
PM3018AE	Té tengi	18 - 15 - 18 mm
PM3022AE	Té tengi	22 - 15 - 22 mm

Hækkun á festingar

Vörunúmer	Gerð	Ø (mm)
PCSE	Hækkun	

Veggplatti

Vörunúmer	Gerð	Ø (mm)	*
JG-L-WSK	Veggplatti	5 x 1/2"	

Hné tengi

Vörunúmer	Gerð	Ø (mm)
PM0304E	Hné tengi	4 mm
PM0306E	Hné tengi	6 mm
PM0308E	Hné tengi	8 mm
PM0310E	Hné tengi	10 mm
PM0312E	Hné tengi	12 mm
PM0315E	Hné tengi	15 mm
PM0318E	Hné tengi	18 mm
PM0322E	Hné tengi	22 mm
PM0328E	Hné tengi	28 mm

N-hné

Vörunúmer	Gerð	Ø (mm)	*
PM090411E	N-hné	4 mm	1/8"
PM090412E	N-hné	4 mm	1/4"
PM090611E	N-hné	6 mm	1/8"
PM090612E	N-hné	6 mm	1/4"
PM090811E	N-hné	8 mm	1/8"
PM090812E	N-hné	8 mm	1/4"
PM090813E	N-hné	8 mm	3/8"
PM091012E	N-hné	10 mm	1/4"
PM091013E	N-hné	10 mm	3/8"
PM091014E	N-hné	10 mm	1/2"
PM091213E	N-hné	12 mm	3/8"
PM091214E	N-hné	12 mm	1/2"

Hné stút

Vörunúmer	Gerð	Ø (mm)
PM220404E	Hné stút	4 mm
PM220606E	Hné stút	6 mm
PM220808E	Hné stút	8 mm
PM221010E	Hné stút	10 mm
PM221212E	Hné stút	12 mm
PM221515E	Hné stút	15 mm
PM221818E	Hné stút	18 mm
PM222222E	Hné stút	22 mm
PM222222E	Hné stút	22 mm

Samtengi

Vörunúmer	Gerð	Ø (mm)
PM0404E	Samtengi	4 mm
PM0406E	Samtengi	6 mm
PM0408E	Samtengi	8 mm
PM0410E	Samtengi	10 mm
PM0412E	Samtengi	12 mm
PM0415E	Samtengi	15 mm
PM0418E	Samtengi	18 mm
PM0422E	Samtengi	22 mm
PM0428E	Samtengi	28 mm

Samtengi - minnkun

Vörunúmer	Gerð	Ø (mm)
PM200604E	Minnkun	6 mm - 4 mm
PM200804E	Minnkun	8 mm - 4 mm
PM200806E	Minnkun	8 mm - 6 mm
PM201006E	Minnkun	10 mm - 6 mm
PM201008E	Minnkun	10 mm - 8 mm
PM201208E	Minnkun	12 mm - 8 mm
PM201210E	Minnkun	12 mm - 10 mm

Stúttengi

Vörunúmer	Gerð	Ø (mm)	*
PM050412E	Stúttengi	4 mm	1/4"
PM050611E	Stúttengi	6 mm	1/8"
PM050612E	Stúttengi	6 mm	1/4"
PM050811E	Stúttengi	8 mm	1/8"
PM050812E	Stúttengi	8 mm	1/4"
PM051012E	Stúttengi	10 mm	1/4"
PM051013E	Stúttengi	10 mm	3/8"
PM051213E	Stúttengi	12 mm	3/8"
PM051214E	Stúttengi	12 mm	1/2"
PM051513E	Stúttengi	15 mm	3/8"
PM051514E	Stúttengi	15 mm	1/2"
PM051814E	Stúttengi	18 mm	1/2"
PM052214E	Stúttengi	22 mm	1/2"
PM052216E	Stúttengi	22 mm	3/4"

Gegnumtak

Vörunúmer	Gerð	Ø (mm)
PM1206E	Gegnumtak	6 mm
PM1208E	Gegnumtak	8 mm
PM1210E	Gegnumtak	10 mm
PM1212E	Gegnumtak	12 mm

Vatnskilja

Vörunúmer	Gerð	Ø (mm)
PMTT22E	Vatnskilja	22 mm



Rör

Vörunúmer	Gerð	Ø (mm)	M
PA-RM1512-3M-20B	Rör - blá	12 mm	3 m
PA-RM1814-3M-20B	Rör - blá	18 mm	3 m
PA-RM2218-3M-20B	Rör - blá	22 mm	3 m
PA-RM2823-3M-10B	Rör - blá	28 mm	3 m



Loftslöngur - 100 m á rúllu

Vörunúmer	Gerð	Ø (mm)	M
PE-0604-0100M-B	blá	6 mm	100
PE-0604-0100M-E	svört	6 mm	100
PE-0604-0100M-N	glær	6 mm	100
PE-0604-0100M-R	rauð	6 mm	100
PE-0604-0100M-W	hvít	6 mm	100
PE-0806-0100M-B	blá	8 mm	100
PE-0806-0100M-E	svört	8 mm	100
PE-0806-0100M-N	glær	8 mm	100
PE-0806-0100M-R	rauð	8 mm	100
PE-0806-0100M-W	hvít	8 mm	100
PE-1007-0100M-B	blá	10 mm	100
PE-1007-0100M-E	svört	10 mm	100
PE-1007-0100M-N	glær	10 mm	100
PE-1007-0100M-R	rauð	10 mm	100
PE-1007-0100M-W	hvít	10 mm	100
PE-1209-0100M-B	blá	12 mm	100
PE-1209-0100M-E	svört	12 mm	100
PE-1209-0100M-N	glær	12 mm	100
PE-1209-0100M-R	rauð	12 mm	100
PE-15115-0100M-B	blá	15 mm	100
PE-15115-0100M-R	rauð	15 mm	100



Rörafesting

Vörunúmer	Gerð	Ø (mm)
PC15E	Rörafesting	15 mm
PC16W	Rörafesting	16 mm
PC18E	Rörafesting	18 mm
PC20W	Rörafesting	20 mm
PC22E	Rörafesting	22 mm
PC28E	Rörafesting	28 mm



Röraklippa

Vörunúmer	Gerð	Ø (mm)
JG-TS	röraklippa	fyrir rör allt að 22 mm

FITTINGS FYRIR NEYSLUVATNSLAGNIR ÚR PLASTI - ÞRÝSTA OG SMELLA



Nippiltengi

Vörunúmer	Gerð	Ø (mm)	*
PI010812S		1/4"	1/4"
PI011212S		3/8"	1/4"



Nippiltengi

Vörunúmer	Gerð	Ø (mm)	*
PI011202S		3/8"	1/4"
PI011203S		3/8"	3/8"



Stúthné

Vörunúmer	Gerð	Ø (mm)	*
PI220808S		1/4"	1/4"



Múffutengi

Vörunúmer	Gerð	Ø (mm)	*
PI450822S	Múffutengi	1/4"	1/4"
PI451222S	Múffutengi	3/8"	1/4"



Hné

Vörunúmer	Gerð	Ø (mm)	*
PI0308S		1/4"	

Samtengi

Vörunúmer	Gerð	Ø (mm)
PEM0412W		12 mm
PEM0416W		16 mm
PEM0420W		20 mm

Hné

Vörunúmer	Gerð	Ø (mm)
PEM0312W		12 mm
PEM0316W		16 mm
PEM0320W		20 mm

Stúthné

Vörunúmer	Gerð	Ø (mm)
PEM221616W		16 mm 16 mm
PEM222020W		20 mm 20 mm

Té

Vörunúmer	Gerð	Ø (mm)
PEM0212W		10 mm
PEM0216W		15 mm
PEM02220W		22 mm

Té m/minnkun

Vörunúmer	Gerð	Ø (mm)
PEM3020BW		20 x 16 x 16
PEM3020AW		20 x 20 x 16

Múffutengi

Vörunúmer	Gerð	Ø (mm)
PEMSTC1614		16 mm x 1/2"
PEMSTC2016		20 mm x 3/4"

Blindlok

Vörunúmer	Gerð	Ø (mm)
PSE4612W		12 mm
PSE4616W		16 mm
PSE4620W		20 mm

Minnkun

Vörunúmer	Gerð	Ø (mm)
PEM061612W		16 mm x 10 mm
PEM061615W		16 mm x 15 mm
PEM062016W		20 mm x 15 mm

Rör í rúllum

Vörunúmer	Gerð	Ø (mm)
16BPEX-50C		16 x 50
20BPEX-50C		20 x 50

Rör

Vörunúmer	Gerð	Ø (mm)
12BPEX-12x3L		12 x 3
16BPEX-16x3L		16 x 3
20BPEX-20x3L		20 x 3

Innlegg

Vörunúmer	Gerð	Ø (mm)
TSM16		16
TSM20		20

Extra þétt innlegg

Vörunúmer	Gerð	Ø (mm)
STS16		16
STS20		20

Loki

Vörunúmer	Gerð	Ø (mm)
16HSV		16
20HSV		20

VEGGHNÉ ÚR KOPAR

Vörunúmer	Gerð	Ø (mm)
16WB	1	6 x 1/2"
20WB		20 x 3/4"

NIPPILTENGI (M/STÚT)

Vörunúmer	Gerð	Ø (mm)
MW051614		16 x 1/2"
MW052014		20 x 1/2"

Umbreyta Speedfit að karl tengingu

Nippiltengi

Vörunúmer	Gerð	Ø (mm)
MW011614		16mm x 1/2" BSP
MW011616		16mm x 3/4" BSP
MW012014		20 x 1/2" BSP
MW012016		20 x 3/4" BSP
12 mc		1/2"
12 mc		3/8"

MW011504N	25
MW051614	16
MW501614	69

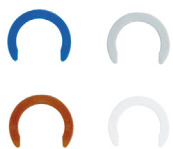

Splittin koma í veg fyrir að rörin muni losna

Splitti

Vörunúmer	Gerð	Ø (mm)
CM1816W	White	16
CM1820W	White	20
CM1816R	Red	16
CM1820R	Red	20
CM1816B	Blue	16
CM1820B	Blue	20

Röraklippur

Vörunúmer	Gerð	Ø (mm)
JG-TS		20 mm

PEM0315W	30
PEM0410W	40
PEM0220W	46
PEM0215W	8
PEM0415W	39
PEM221212W	84
PEM221515W	70
PEM531212W	86
PEMSTC1214	38

PEMSTC1514	15
PEMSTC1516	31
ST510	101
ST512	685
ST515	450
ST516	613
ST520	599
TSM12	448

LOFTLOKAR

ÞRÝSTIJA FNARAR - SÍUR - OLÍUGLÖS - MJÚKSTARTLOKAR



SEGULLOKAR / SY3000/5000/7000/9000

SY 5 1 20 5 L 01 **-Q**

A, B port stærð

Práðarlögn

Symbol	Port size	Applicable series
M5	M5	SY3000
01	1/8	SY5000
02	1/4	SY7000
03	3/8	SY9000

Gerð

3	SY3000
5	SY5000
7	SY7000
9	SY9000

Virkjun

1	2 position single (A)(B)
2	2 position double (A)(B)
3	3 position closed center (A)(B)
4	3 position exhaust center (A)(B)
5	3 position pressure center (A)(B)

Upplýsingar um spólu

- Standard

T Með orkusparandi hringrás (24, fyrir 12 VDC)

Orkusparandi hringrás er ekki í boði ef um er að ræða D, DO eða W gerð

Fyrir DC

5	24 VDC
6	12 VDC
V	6 VDC
S	5 VDC
R	3 VDC

Fyrir AC (50/60 Hz)

1	100 VAC
2	200 VAC
3	110 VAC [115 VAC]
4	220 VAC [230 VAC]

DC forskrift týpa D og DO eru aðeins fánlegar með 12 og 24 VDC

AC forskrift er aðeins fánleg með D, DO gerð

Spenna

Práðarlögn

-	Rc
F	G
N	NPT
T	NPTF

Eingöngu fyrir M5

Bracket

-: Without bracket
F1: With foot bracket (2 position single only)
F2: With side bracket

Engin festing í SY9000

Rafmagns inngangur

24, 12, 6, 5, 3 VDC				24, 12 VDC/ 100, 110, 200, 220 VAC
Grommet	L plug connector	M plug connector	DIN terminal ^(Note2)	
G: Lead wire length 300 mm	L: With lead wire (Length 300 mm)	M: With lead wire (Length 300 mm)	MN: Without lead wire	D: With connector
H: Lead wire length 600 mm	LN: Without lead wire	LO: Without connector	MO: Without connector	DO: Without connector

24, 12, 6, 5, 3 VDC

M8 connector *

WO: Without connector cable

W□: With connector cable (Note 1)

- LN, MN gerð: með 2 innstungum.
- Fyrir DIN tengi í SY3000 seríunni.
- DIN tengi gerð „Y“ sem er í samræmi við EN-175301-803C (fyrrum DIN43650C) er einnig fánleg.
- Fyrir tengisnúru á M8 tengi.
- Tengi M8 gerð „WA“ í samræmi við IEC 60947-5-2 staðal er einnig fánlegt.

Handvirk yfirkeysla

-: Non-locking push type

D: Push-turn locking slotted type

E: Push-turn locking lever type

Ljós / bylgjuspenna

Rafmagnsinngangur fyrir G, H, L, M, W

-	Without light/surge voltage suppressor
S	With surge voltage suppressor
Z	With light/surge voltage suppressor
R	With surge voltage suppressor (Non-polar type)
U	With light/surge voltage suppressor (Non-polar type)

-	Without light/surge voltage suppressor
S	With surge voltage suppressor
Z	With light/surge voltage suppressor

SY5000 gerðir



Loftloki - f/2 víra tengi

Vörunúmer	Gerð	Din skinna
SY5120-5MOU-01F-Q	Tvívirkur - 1 spólur - 24V/DC	5/3, 1/8
SY5220-5MOU-01F-Q	Tvívirkur - 2 spólur - 24V/DC	5/2, 1/8
SY5320-5MOU-01F-Q	Lokuð miðstaða - 24V/DC	5/3, 1/8
SY5420-5MOU-01F-Q	Opinn miðstaða - 24V/DC	5/3, 1/8



Loftloki

Vörunúmer	Gerð	Din skinna
SY5120-5DOSD-01F-Q	Tvívirkur - 1 spóla - 24V/DC	5/2, 1/8
SY5220-5DOSD-01F-Q	Tvívirkur - 2 spólur - 24V/DC	5/2, 1/8
SY5320-5DOSD-01F-Q	Lokuð miðstaða - 24V/DC	5/3, 1/8
SY5420-5DOSD-01F-Q	Opinn miðstaða - 24V/DC	5/3, 1/8



Loftloki

Vörunúmer	Gerð	Din skinna
SY5120-4DOSD-01F-Q	Tvívirkur - 1 spóla - 230V	5/2, 1/8
SY5220-4DOSD-01F-Q	Tvívirkur - 2 spólur - 230V	5/2, 1/8
SY5320-4DOSD-01F-Q	Lokuð miðstaða - 230V	5/3, 1/8
SY5420-4DOSD-01F-Q	Opinn miðstaða - 230V	5/3, 1/8



Botnplata - fyrir 5120 loka

Vörunúmer	Gerð	Stk.
SS5Y5-20-02-00F-Q	f/5120 loka	2
SS5Y5-20-04-00F-Q	f/5120 loka	4
SS5Y5-20-06-00F-Q	f/5120 loka	6
SS5Y5-20-08-00F-Q	f/5120 loka	8
SS5Y5-20-10-00F-Q	f/5120 loka	10
SS5Y5-20-12-00F-Q	f/5120 loka	12



Blindplata

Vörunúmer	Gerð
SY5000-26-1A-Q	Blindplata fyrir botnplötu

SY7000 gerðir

Loftloki - f/2 víra tengi

Vörunúmer	Gerð	Din skinna
SY7120-5MOU-01F-Q	Tvívirkur - 1 spólur - 24V/DC	5/3, 1/4
SY7220-5MOU-01F-Q	Tvívirkur - 2 spólur - 24V/DC	5/2, 1/4
SY7320-5MOU-01F-Q	Lokuð miðstaða - 24V/DC	5/3, 1/4
SY7420-5MOU-01F-Q	Opinn miðstaða - 24V/DC	5/3, 1/4

Loftloki

Vörunúmer	Gerð	Din skinna
SY7120-5DOSD-01F-Q	Tvívirkur - 1 spóla - 24V/DC	5/2, 1/4
SY7220-5DOSD-01F-Q	Tvívirkur - 2 spólur - 24V/DC	5/2, 1/4
SY7320-5DOSD-01F-Q	Lokuð miðstaða - 24V/DC	5/3, 1/4
SY7420-5DOSD-01F-Q	Opinn miðstaða - 24V/DC	5/3, 1/4

Loftloki

Vörunúmer	Gerð	Din skinna
SY7120-4DOSD-01F-Q	Tvívirkur - 1 spóla - 230V	5/2, 1/4
SY7220-4DOSD-01F-Q	Tvívirkur - 2 spólur - 230V	5/2, 1/4
SY7320-4DOSD-01F-Q	Lokuð miðstaða - 230V	5/3, 1/4
SY7420-4DOSD-01F-Q	Opinn miðstaða - 230V	5/3, 1/4



Botnplata - fyrir 7120 loka

Vörunúmer	Gerð	Stk.
SS5Y7-20-02-00F-Q	f/7120 loka	2
SS5Y7-20-04-00F-Q	f/7120 loka	4
SS5Y7-20-06-00F-Q	f/7120 loka	6
SS5Y7-20-08-00F-Q	f/7120 loka	8
SS5Y7-20-10-00F-Q	f/7120 loka	10
SS5Y7-20-12-00F-Q	f/7120 loka	12



Blindplata

Vörunúmer	Gerð
SY7000-26-1A-Q	Blindplata fyrir botnplötu

SY9000 gerðir

Loftloki - f/2 víra tengi

Vörunúmer	Gerð	Din skinna
SY9120-5MOU-02F-Q	Tvívirkur - 1 spólur - 24V/DC	5/3, 1/4
SY9220-5MOU-02F-Q	Tvívirkur - 2 spólur - 24V/DC	5/2, 1/4
SY9320-5MOU-02F-Q	Lokuð miðstaða - 24V/DC	5/3, 1/4
SY9420-5MOU-02F-Q	Opinn miðstaða - 24V/DC	5/3, 1/4

Loftloki

Vörunúmer	Gerð	Din skinna
SY9120-5DOSD-03F-Q	Tvívirkur - 1 spóla - 24V/DC	5/2, 3/8
SY9220-5DOSD-03F-Q	Tvívirkur - 2 spólur - 24V/DC	5/2, 3/8
SY9320-5DOSD-03F-Q	Lokuð miðstaða - 24V/DC	5/3, 3/8
SY9420-5DOSD-03F-Q	Opinn miðstaða - 24V/DC	5/3, 3/8

Loftloki

Vörunúmer	Gerð	Din skinna
SY9120-4DOSD-03F-Q	Tvívirkur - 1 spóla - 230V	5/2, 3/8
SY9220-4DOSD-03F-Q	Tvívirkur - 2 spólur - 230V	5/2, 3/8
SY9320-4DOSD-03F-Q	Lokuð miðstaða - 230V	5/3, 3/8
SY9420-4DOSD-03F-Q	Opinn miðstaða - 230V	5/3, 3/8



Botnplata - fyrir 9120 loka

Vörunúmer	Gerð	Stk.
SS5Y9-20-02-00F-Q	f/9120 loka	2
SS5Y9-20-04-00F-Q	f/9120 loka	4
SS5Y9-20-06-00F-Q	f/9120 loka	6
SS5Y9-20-08-00F-Q	f/9120 loka	8
SS5Y9-20-10-00F-Q	f/9120 loka	10
SS5Y9-20-12-00F-Q	f/9120 loka	12



Blindplata

Vörunúmer	Gerð
SY9000-26-1A-Q	Blindplata fyrir botnplötu

RAFTENGI



Tengi - fyrir 2 víra

Vörunúmer	Gerð	Lengd
SY100-30-4A-10	Tengi fyrir M loka	1 m



Raftengi

Vörunúmer	Gerð	Spenna
SY100-82-3-05-24DC	Tengi f/ Y loka	24V DC



Raftengi

Vörunúmer	Gerð	Spenna
VK300-37-3-05-24DC	Tengi f/ D loka	24V DC
VK300-37-3-05-220V	Tengi f/ D loka	220V

SY5000 gerðir

Loftloki - f/2 víra tengi

Vörunúmer	Gerð	Din skinna
SY5160-5MOU-01F-Q	Tvívirkur - 1 spólur - 24V/DC	5/3, 1/8
SY5260-5MOU-01F-Q	Tvívirkur - 2 spólur - 24V/DC	5/2, 1/8
SY5360-5MOU-01F-Q	Lokuð miðstaða - 24V/DC	5/3, 1/8
SY5460-5MOU-01F-Q	Opinn miðstaða - 24V/DC	5/3, 1/8

Loftloki

Vörunúmer	Gerð	Din skinna
SY5160-5DOSD-01F-Q	Tvívirkur - 1 spóla - 24V/DC	5/2, 1/4
SY5260-5DOSD-01F-Q	Tvívirkur - 2 spólur - 24V/DC	5/2, 1/4
SY5360-5DOSD-01F-Q	Lokuð miðstaða - 24V/DC	5/3, 1/4
SY5460-5DOSD-01F-Q	Opinn miðstaða - 24V/DC	5/3, 1/4

230V

Loftloki

Vörunúmer	Gerð	Din skinna
SY5160-4DOSD-01F-Q	Tvívirkur - 1 spóla - 230V	5/2, 1/4
SY5260-4DOSD-01F-Q	Tvívirkur - 2 spólur - 230V	5/2, 1/4
SY5360-4DOSD-01F-Q	Lokuð miðstaða - 230V	5/3, 1/4
SY5460-4DOSD-01F-Q	Opinn miðstaða - 230V	5/3, 1/4

AUKAHLUTIR

Festing - f/síuhús

Vörunúmer	Gerð	Stun (µm)
AF30P-050AS	Festing á AF30 síuhús	

Pakkning

Vörunúmer	Gerð
SY5000-GS-1	fyrir 5120 loka á botnplötu

SY7000 gerðir

Loftloki - f/2 víra tengi

Vörunúmer	Gerð	Din skinna
SY7160-5MOU-01F-Q	Tvívirkur - 1 spólur - 24V/DC	5/3, 1/4
SY7260-5MOU-01F-Q	Tvívirkur - 2 spólur - 24V/DC	5/2, 1/4
SY7360-5MOU-01F-Q	Lokuð miðstaða - 24V/DC	5/3, 1/4
SY7460-5MOU-01F-Q	Opinn miðstaða - 24V/DC	5/3, 1/4

Loftloki

Vörunúmer	Gerð	Din skinna
SY7160-5DOSD-01F-Q	Tvívirkur - 1 spóla - 24V/DC	5/2, 1/4
SY7260-5DOSD-01F-Q	Tvívirkur - 2 spólur - 24V/DC	5/2, 1/4
SY7360-5DOSD-01F-Q	Lokuð miðstaða - 24V/DC	5/3, 1/4
SY7460-5DOSD-01F-Q	Opinn miðstaða - 24V/DC	5/3, 1/4

Loftloki

Vörunúmer	Gerð	Din skinna
SY7160-4DOSD-01F-Q	Tvívirkur - 1 spóla - 230V	5/2, 1/4
SY7260-4DOSD-01F-Q	Tvívirkur - 2 spólur - 230V	5/2, 1/4
SY7360-4DOSD-01F-Q	Lokuð miðstaða - 230V	5/3, 1/4
SY7460-4DOSD-01F-Q	Opinn miðstaða - 230V	5/3, 1/4

Veggfesting - f/síuhús

Vörunúmer	Gerð	stærð
AM-BM102	Veggfesting f/síuhús	
AM-BM103	Veggfesting f/síuhús	

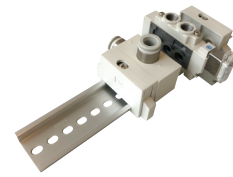
AUKAHLUTIR

Plata og loki

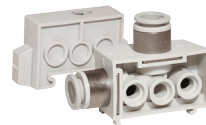
Vörunúmer	Gerð	Virkni
SS5Y5-60-08D-Q	Endastykki f/5160	f/8 loka
SS5Y5-60-08D-U	Endastykki f/5160	f/8 loka

Inntak

Vörunúmer	Gerð	Din skinna
SY5000-55-1A-Q	Inntak á skinnu	f/5160
SY5000-56-1A-Q	Endastykki á skinnu	f/5160
SY5000-56-1B-Q	Endastykki á skinnu	f/5160

RAFTENGI

Raftengi

Vörunúmer	Gerð	L/min *
DIN43650AL	stórt 230V LED yfirsp	
DIN43650AZ	24V DC m/LED og Zener	
DIN43650BL	miðst 230V LED yfirsp	
DIN43650BY	f. SMC loka	
DIN43650BYZ	miðst. 24V dc	
DIN43650BZ	miðst. 24V LED Zener	
DIN43650CZ	miðst. 24V	
DIN43650B	f.loka VO307 24V AC standard	

Einstefnuloki

Vörunúmer	Gerð	stærð
AKH06-00	fyrir slöngur	6 mm
AKH08-00	fyrir slöngur	8 mm
AKH10-00	fyrir slöngur	10 mm
AKH12-00	fyrir slöngur	12 mm

Einstefnuloki

Vörunúmer	Gerð	stærð
AKB01A-01S	Einstefnuloki	1/8"
AKB02A-02S	Einstefnuloki	1/4"
AKB02B-02S	Einstefnuloki	1/4"
AKB03A-03S	Einstefnuloki	3/8"
AKB04A-04S	Einstefnuloki	1/2"
AKB04B-04S	Einstefnuloki	1/2"
AKH04A-M5	Einstefnuloki	04-5mm
AKH04B-M5	Einstefnuloki	04-5mm
AKH06-00	Einstefnuloki	F/6mm slöngu
AKH06B-01S	Einstefnuloki	6mm -> 1/8"
AKH08-00	Einstefnuloki	F/8mm slöngu
AKH08-03S	Einstefnuloki	8mm - 3/8"
AKH08A-02S	Einst.loki	8mm, 1/4/05bar SMC™
AKH08A-03S	Einstefnuloki	8mm - 3/8"
AKH10-00	Einstefnuloki	F/10mm slöngu
AKH10A-03S	Einstefnuloki	10mm - 3/8"
AKH10B-03S	Einstefnuloki	10mm - 3/8"
AKH12-00	Einstefnuloki	F/12mm slöngu
AKH12A-03S	Einstefnuloki	12mm - 3/8"

Einstefnuþrenging - ryðfri

Vörunúmer	Gerð	Gengjustærð
AS3001FG-06	Einstefnuþrenging	6 mm
AS2051FG-08	Einstefnuþrenging	8 mm
AS3001FG-10	Einstefnuþrenging	10 mm
AS3001FG-12	Einstefnuþrenging	12 mm

Einstefnuþrenging + festing

Vörunúmer	Gerð	Límin
AS2052F-06-X214	6mm slanga í báðar áttir	
AS2052F-06	6mm slanga+festing	
AS2052F-08	8mm slanga+festing	

Einstefnuþrenging

Vörunúmer	mm	Gerð
AS3001F-08	8mm	slanga
AS3001F-10	10mm	slanga
AS3001F-12	12mm	slanga
AS3001FG-08	8mm	slanga ryðfri /plast
AS3001FG-10	10mm	slanga ryðfri
AS3001FG-12	12mm	slanga ryðfri
AS3002FS-10	10mm	m/skifu
AS3201F-G03-12A		

Hné þrenging

Vörunúmer	Gerð	mm	"
AS2201F-01-04S	plast	6mm	1/8"
AS2201F-01-06S	plast	6mm	1/8"
AS2201F-01-08S	plast	8mm	1/8"
AS2201F-02-06S	plast	6mm	1/4"
AS2201F-02-08S	plast	8mm	1/4"

Hnéþrenging

Vörunúmer	Gerð	mm	"
AS2211F-02-08S	plast	8mm	1/4"
AS2211FG-02-08S	ryðfri	8mm	1/4"

Hraðaftöppun

Vörunúmer	Gerð	Gengjustærð
AQ240F-04-00	Hraðaftöppun	4mm

Hné þrenging - ryðfri

Vörunúmer	Gerð	mm	"
ASP330F-01-06S	6mm slanga	1/8"	m/afloftun
ASV310F-02-08S	8mm slanga	m/afloftun	
ASD330F-01-08S	RF	8mm	1/8"
ASD330FG-03-08S	RF	8mm	3/8"
ASD530F-03-08S		8mm	3/8"
AS3201FG-02-10S	RF	10mm	1/4"
AS3201FG-03-10S	RF	10mm	3/8"

Þrenging - ryðfri

Vörunúmer	Gerð	Gengjustærð
AS2051FG-06	Þrenging RF	6 mm
AS2051FG-08	Þrenging RF	8 mm
AS2051FG-10	Þrenging RF	10 mm
AS2051FG-12	Þrenging RF	12 mm

Hnéþrenging - ryðfri

Vörunúmer	Gerð	Gengjustærð
AS2201FG-01-06S	Hnéþrenging	6 mm -1/8"
AS2201FG-01-08S	Hnéþrenging	8 mm -1/8"
AS2201FG-02-06S	Hnéþrenging	6 mm -1/4"
AS2201FG-02-08S	Hnéþrenging	8 mm -1/4"
AS3201FG-02-10S	Hnéþrenging	10 mm -1/4"
AS3201FG-03-10S	Hnéþrenging	10 mm -3/8"

Handloki - Plast

Vörunúmer	Gerð	stærð
VHK3-06F-06F	3/2 f/ slöngu	6 mm
VHK3-08F-08F	3/2 f/ slöngu	8 mm
VHK3-10F-10F	3/2 f/ slöngu	10 mm
VHK3-12F-12F	3/2 f/ slöngu	12 mm

Handloki - Plast

Vörunúmer	Gerð	stærð
VHK2-06F-06F	2/2 f/ slöngu	6 mm
VHK2-08F-08F	2/2 f/ slöngu	8 mm
VHK2-10F-10F	2/2 f/ slöngu	10 mm
VHK2-12F-12F	2/2 f/ slöngu	12 mm

Handloki

Vörunúmer	Gerð	Týpa	Gengjustærð
VHK2A	2/2 lokar	Ø4 til Ø12	M5, 1/8 til 1/2
VHK3A	3/2 lokar	Ø4 til Ø12	M5, 1/8 til 1/2

Handloki - Plast

Vörunúmer	Gerð	stærð
VHK3-01S-01S	3/2 lokar	1/8"
VHK3-02S-02S	3/2 lokar	1/4"
VHK3-03S-03S	3/2 lokar	3/8"
VHK3-04S-04S	3/2 lokar	1/2"

Handloki

Vörunúmer	Gengjustærð	Þrýstingur (MP)
VH200 til VH600	1/4, 3/8, 3/4, 1/2	0.1 til 1

Handloki - Plast

Vörunúmer	Gerð	stærð
VHK2-06F-03S	2/2 lokar	6 mm - 3/8"

ÞRÝSTIJAFNARAR - SÍUR - OLÍUGLÖS - MJÚKSTARTLOKAR

AMG

Vatnssilja
[Siun skilvirkni: 99%]

Gerð	L/min	Gengjustærð
150C	300	1/8, 1/4
250C	750	1/4, 3/8
350C	1,500	3/8, 1/2
450C	2,200	1/2, 3/4
550C	3,700	3/4, 1
650	6,000	1, 1 1/2
850	12,000	1 1/2, 2

AFF

Venjulega sía: 3 µm
[Siun skilvirkni: 99%]

Gerð	L/min	Gengjustærð
2C	300	1/8, 1/4
4C	750	1/4, 3/8
8C	1,500	3/8, 1/2
11C	2,200	1/2, 3/4
22C	3,700	3/4, 1
37B	6,000	1, 1 1/2
75B	12,000	1 1/2, 2

AM

Venjulega sía: 0.3 µm
[Siun skilvirkni: 99.9%]

Gerð	L/min	Gengjustærð
150C	300	1/8, 1/4
250C	750	1/4, 3/8
350C	1,500	3/8, 1/2
450C	2,200	1/2, 3/4
550C	3,700	3/4, 1
650	6,000	1, 1 1/2
850	12,000	1 1/2, 2

AMD

Venjulega sía: 0.01 µm
[Siun skilvirkni: 99.9%]

Gerð	L/min	Gengjustærð
150C	300	1/8, 1/4
250C	750	1/4, 3/8
350C	1,500	3/8, 1/2
450C	2,200	1/2, 3/4
550C	3,700	3/4, 1
650	6,000	1, 1 1/2
850	12,000	1 1/2, 2

Vatnssilja - sjálfvirk aftöppun

[Siun skilvirkni: 99%]

Vörunúmer	Gerð	L/min	Gengjustærð
AMG150C-F02D	aftöppun	300	1/8", 1/4"
AMG250C-F03D	aftöppun	750	1/4", 3/8"
AMG350C-F04D	aftöppun	1,500	3/8", 1/2"
AMG450C-F06D	aftöppun	2,200	1/2", 3/4"
AMG550C-F10BD	aftöppun	3,500	3/4", 1"

SÍUR



Sía - 2 mikron

Vörunúmer	Gerð	*	Siun (µm)
AF40-F04D-7-2-A	Aftöppun	3/4	0.02
AF30-F03D-7-2-A	Aftöppun	3/8	0.02

AF-50-F05D-7-2	Sía 3/4"	2 mikron auto drain
AF-60-F06D-7-2	Sía 1"	2 mikron auto drain

AF-3000-F03D-2	Sía 5 mikron 3/8"	auto drain
AF-3000-F03D-7-2	Sía 3/8"	2 mikron auto drain

AF-4000-F04D-7-2	Sía 1/2"	2 mikron auto drain
------------------	----------	---------------------

AF-60-F10-A	Sía	1"
AF20-01-J-A	Sía 5my m/autodrain	1/8
AF20-F01-A	Sía m/autodrain	1/8
AF20-F01C	Sía m/autodrain	1/8
AF20-F02-2-A	Sía m/autodrain	1/8
AF20-F02C	Sía m/autodrain	1/4
AF60-F10C-A	Sía 1"	5 mikron auto drain



Sía - 2 mikron

Vörunúmer	Gerð	*	Siun (µm)
AF30-F03D-7-2-A	Sía.3/8"	2 mikron auto drain	
AF40-F04D-7-2	Sía 1/2"	2 mikron auto drain	



Sía - á stofn

Vörunúmer	Gerð	L/min	*	Siun (µm)
AFF11B-F06D-T	Aftöppun	2200 L	3/4"	3my
AFF4B-F03D-T	Aftöppun	750 l	3/8"	3my
AFF4C-F03D-T	Aftöppun	750 l	3/8"	3my
AFF8B-F04D-T	Aftöppun	1500 l	1/2"	3my



Sía

Vörunúmer	Gerð	L/min	*
AMD250C-F02-T	1/4"	0,01 mikron	500 L/min
AMD350C-F03-T	3/8"	0,01 mikron	1000 L/min
AMD450C-F04-T	1/2"	0,01mikron	2000 L/Min
AMD550-F10D-T	1"	0,01mikron	3700 L/Min
AMD550C-F06-T	3/4"	0,01mikron	3700 L/Min
AMD650-F10-T	1"-1 1/2"	0,01mikron	6000 L/Min
MICRO MIST SEPARATOR			
AMD650-F14	1 1/2"	0,01my	
AMD850-F14	0,3 my	1 1/2"	



Sía -

Vörunúmer	Gerð	L/min	*	Siun (µm)
AFJ20-01-5-S	1/8 vacuum			5 mikron

Sía -

0.01 µm [Siun skilvirkni: 99.9%]

Vörunúmer	Gerð	L/min	Gengjustærð
AMD350D-F03-T	Aftöppun	1000	3/8"
AMD450D-F04-T	Aftöppun	2000	1/2"
AMD550D-F10D-T	Aftöppun	3700	1"

Sía -

0.3 µm [Siun skilvirkni: 99.9%]

Vörunúmer	Gerð	L/min	Gengjustærð
AM350C-F03D-T	Aftöppun	1,500	3/8", 1/2"
AM450C-F03D	Aftöppun	2,200	1/2", 3/4"
AM550C-F03D	Aftöppun	3,700	3/4", 1"

Sía - á stofn

3 µm [Siun skilvirkni: 99%]

Vörunúmer	Gerð	L/min	Gengjustærð
AFF4C-F03D-T	Aftöppun	750	3/8"
AFF8B-F04D-T	Aftöppun	1500	1/2"
AFF11B-F06D-T	Aftöppun	2,200	3/4"

MJÚKSTARTLOKAR



Mjúkstartloki

Vörunúmer	Gerð	L/min	*
EAV2000-F02-5YZ-Q	24VDC	2000 sería	??
EAV3000-F03-5YZ-Q	24VDC	3000 sería	??
EAV4000-F04-5YZ-Q	24VDC	3533	1/2"
EAV4000-F04-5DZC-Q	SMC 1/2"	3533 L/Min	
EAV5000-F06-5DZ-Q	SMC 3/4"		

AV3000-F03-5YZ-Q	24VDC	3000 sería
AV4000-F04-5DZ-Q	24VDC	4000 sería



Flotaftöppun

Vörunúmer	Gengjustærð	Stærð frárennisslop
AD402-F04	1/2	3/8

FÍNSÍA



Fínsía

Vörunúmer	Gerð	L/min
AMH350-F04D-T	Fínsía 0,01 my 1/2"	
AMH450-F06D-T	Fínsía 0,01 my 3/4"	



Fínsía - 1 mikron

Vörunúmer	L/min	Stærð	Slun (µm)
AFD40-F04	600	1/2"	0,01
AFD40-F04-A	600	1/2"	0,01
AFD30-F03-A	240	3/8"	0,01
AFD-3000-F03	240 l/min*	3/8"	0,01 mikron
AFD-40-F04	600 l/min*	1/2"	0,01 mikron
AFD-4000-F04	600 l/min*	1/2"	0,01 mikron
AFD20-F01C-A		1/8"	0,01 mikron



Fínsía

Vörunúmer	Gerð	L/min
AMF350C-F03	Fínsía 3/8"	



Fínsía

Vörunúmer	Gerð	L/min
EAFD-3000-F03	Fínsía 0,01 mikron 3/8"	
EAFD-4000-F03	Fínsía 0,01 mikron 3/8"	
EAFD-4000-F04	Fínsía 0,01 mik 1/2 600l/min"	
EAM250-F02D-T	SMC microsia 0,3m auto drain	
EAM350-F03D	Fínsía 0,3m 3/8\ autodrain"	
EAM450-F04D-T	Fínsía 0,3m 1/2\ autodrain"	
EAM450-F06D	Fínsía 0,3m 3/4 autodrain"	
EAMD-350-F03-T	Fínsía 3/8" 0,01 mikron	
EAMD-550-F06-T	SMC submikro 0,01mikron 3/4	
EAMD250-F02-T	SMC submicrosia 0,01mikron	
EAMD450-F04-T	SMC submicrosia 0,01mikron	
EAM550-F10D	SMC Mist vatnskilja 1"	



Fínsía - 3 mikron

Vörunúmer	L/min	Slun (µm)
AFM30-F03-A	0,3 mik 3/8\ 240l/min"	
AFM40-F04-A	0,3 mik 1/2\ 600l/min"	



Millistykki f/brýstjafnari ofl.

Vörunúmer	Gerð	L/min
Y300-A-X260	Millistykki f/ 3000 - málað	

OLÍUGLÖS



Glas - í AMG450

Vörunúmer	Gerð	stærð
AM-CA450C-A	Glas í AMG450	



Oliuglas

Vörunúmer	Gerð	Afkastageta (cm3)
AL20-F03-A	Smurtæki 3/8"	0,01



Oliuglas

Vörunúmer	Gerð	Afkastageta (cm3)
AL30-F04-A	Smurtæki 3/8"	0,01
AL40-F03-A	Smurtæki 1/2"	0,01

Glas

Vörunúmer	Gerð	stærð
EAD43	Glas í EAW3000 með sj. aftöppun	
EAD44	Glas í EAW4000 með sj. aftöppun	

Glas - í AMG450

Vörunúmer	Gerð	stærð
AM-CA450C-A	Glas í AMG450	

Glas

Vörunúmer	Gerð	L/min
C2SF-J-A	í brýstjafnara 1/8 A20	
C2SL-C-A	í Smurtæki 1/8 AL20	
C400F	í EAW4000 án sj. aftöppunar	
C4LF-8	f/síuhús AF40	
C4SF	í Smurtæki 1/2" AF40	
C4SL	í Smurtæki 1/2" AL40	

SMURTÆKI



Smurtæki

Vörunúmer	Gerð	stærð
AL20-F01	fyrir 2000 seríu 1/8"	
AL20-F02	2000 sería 1/4	
AL20-F02-A	2000 sería 1/4 hvítt	



Smurtæki - nýrri gerð

Vörunúmer	Gerð	stærð
AL20-F02-C-A	hvítt	1/8"
AL20P-080AS	sjönglas f/smurtæki f/AL20-AL60	
AL30-F02	Smurtæki	1/4"
AL30-F03	Smurtæki	3/8"
AL30-F03-A	Smurtæki	3/8"
AL40-F04	Smurtæki	1/2"
AL40-F04-A	Smurtæki	1/2"
AL40-F06-A	Smurtæki	3/4"



Loftdempari

Vörunúmer	Gerð	L/min
AN10-C06	Loftdempari 6mm stunginn	
AN103-KM6	Loftdempari 6mm stunginn	
AN15-C08	Loftdempari 8mm stunginn	
AN20-02	Loftdempari 1/4"	
AN20-C10	Loftdempari 10 mm stunginn	
AN200-KM10	Loftdempari 10 mm stunginn	
AN203-KM8	Loftdempari 8mm stunginn	
AN30-03	Loftdempari 3/8"	
AN30-C12	Loftdempari 12mm	
AN500-06	Loftdempari 3/4" 30dB	
ANA1-01	Loftdempari 1/8 -40db	
ANA1-02	Loftdempari 1/4 -40db	
ANA1-03	Loftdempari 3/8 -40db	
ANA1-04	Loftdempari 1/2" stór	
ANA1-06	Loftdempari 3/4"	
ANA1-10	Loftdempari 1" stór	
ANA1-12	Loftdempari 1 1/4"	
ANA1-14	Loftdempari 1 1/2"	

Hljóðdempari

Vörunúmer	Gerð	L/min
ASN2-01-S	Hljóðdempari 1/8 stillanlegur	
ASN2-02-S	Hljóðdempari 1/4 stillanlegur	
ASN2-03-S	Hljóðdempari 3/8 stillanlegur	
ASN2-04-S	Hljóðdempari 1/2 stillanlegur	



Smurtæki

Vörunúmer	Gerð	L/min
EAL-3000-F02	Smurtæki 1/4	
EAL-4000-F03	Smurtæki 3/8	
EAL-4000-F04	Smurtæki 1/2	

PRÝSTIJAFNARAR



Prýstijafnari

Vörunúmer	Gerð L/min
EAR-2000-F01E	Prýstijafnari 1/8" innb. mælir"
EAR-3000-F03G	Prýstij. 0,5-8,5 bar 3/8"
EAR-4000-F03E	Prýstijafnari 3/8" innb. mælir"
EAR-4000-F04G	Prýstijafn. 1/2" m/mæli"
EAR2000-F01	Prýstij. 0,5-8,5 bar
EAR2000-F02	Prýstijafn. (mistök, ekki til)
EAR3000-F02	Prýstijafnari 1/4"
EAR4000-F03	Prýstijafnari 3/8" EAW-2000
F02DG	Prýstij. 0,5-8,5 bar 1/4"
EAW-3000-F02	Prýstijafn. m/siu 5 mik 1/4"
EAW-3000-F02D	Prýstijafnari m/siu 5mik 1/4"
EAW2000-F02D	Prýstijafnari 0,5-10 bar
EAW2001-F01G	Prýstij. 1/8" m/siu & mæli"
EAW3000-F02	



Prýstijafnari

Vörunúmer	Gerð	L/min
AR-1000-M5	5 m/m	
AR20-F01	1/8" 0,05-085 mpa	
AR20-F01-1-B	1/8" 0,2-2 bar	
AR20-F01G-A	1/8" 0,05-0,7 mpa	
AR20-F02	1/4" 2000 seria"	
AR20-F02B-B	1/4" 0,05-085 mpa m/bracke	
AR20-F02H	1/4" 0,05-085 mpa	
AR20-F02H-B	1/4" 0,05-085 mpa	
AR20-N02	1/4" 2000 seria"	
AR20K-F02E	1/4" M/back flow mechanism	



Prýstijafnari

Vörunúmer	Gerð	L/min
AW20-F01C	m/siu 1/8"	
AW20-F02C	m/siu 1/4" autod"	
AW20K-F02-B	m/siu 1/4" autod" hvitt	
AW30-F02DEH-6	1/4" m.siu og sjálfv. aft.mæli	
AW30-F02DH-6	1/4" m.siu og sjálfv. aft.	
AW30-F03-2-X2622C	3/8" ryðfrír	
AW30-F03DEH	3/8" m.siu og sjálfv. aft.	
AW30-F03DH	3/8" m.siu og sjálfv. aft.	
AW30K-F02DE-B	1/4" m.siu og sjálfv.mæli	
AW30K-F03DE-B	3/8" m.siu og sjálfv. aft.	
AW30K-F03DH	3/8" m.siu og sjálfv. aft.	
AW30K-F03D-B	3/8" m.siu og sjálfv. aft.	
AW40-F04D-B	1/2" m.siu & sjálfv.aftópp-mæli	
AW40-F04DE	1/2" m.siu & sjálfv.aft.	
AW40-F04DEH	1/2" m.siu og sjálfv. aft.	
AW40-F04H	1/2" m.siu	
AW40-F06DEH	3/4" m.siu og sjálfv. aft.	
AW40K-F04D-B	1/2" m.siu og sjálfv. aft.	
AW40K-F04DE-B	1/2" m.siu og sjálfv. aft.	
AW60K-F10	1" m.siu	
AW60K-F10D	1" sjálfv. aftóppun 5 my	

Prýstijafnari

Vörunúmer	Gerð	L/min
AR30-F02H-X430	1/4" -30-60°C	
AR40-F04	1/2" 0,5-8,5bar	
AR40-F06EH-B	3/4" 0,5-8,5bar	
AR50-F06	3/4" 0,5-8,5 bar	
AR60-F10	1" 0,5-8,5 bar	
AR60-F10E		
AR825-F14	1 1/2" 0,5-8,5bar	
AR925-F20	2" 0,5-8,5 bar	
ARG20-N01G2-Z	1/8"	
ARJ310F-F01-06	6mm slanga út -1/8" inn	
ARJ310F-F01G-06-S	6mm slanga út -1/8" inn	
ARM10-08-BG	með mæli veggf 6mm nippill	
ARM11A1-S03	Manifold fyrir prýstijafnara 10mm	
ARM11A1-V02	Loki á prýstijafnaraskinnu - fyrir ARM11	
ARM11AA1-R05-A	Prýstijafnari	
ARM11AA1-R05-AZA-P	Prýstijafnari	
ARM11AA4-312-M	Prýstijafnar 3 stk á blok	
ARM11EL	Endastykki vinstra	
ARM11ER	Endastykki Hægri	
ARX20-F01	Prýstijafn. SMC 0,5-30 bar,1/8"	
ARX20-F01B	Prýstijafn. SMC 0,5-8,5 bar,1/8" m/festin	
ARX21-F02	Prýstijafn. SMC 0,5-30 bar,1/4"	



Prýstijafnari - 4-20 MPa

Vörunúmer	Gengjustærð	Prýstingur (MP)
ITV0000-3000	1/8, 1/4, 3/8, 1/2"	0.001 til 0.9



Prýstijafnari - með síu

Vörunúmer	Gerð	Síun (µm)
AFD20 til 40-D	1/8 1/4 3/8 1/2"	0.01
AW30K-F03DE-B	Sjálvvirk aft.	3/8 0.01
AW40K-F04DE-B	Sjálvvirk aft.	1/2 0.01

FILTER



Filter

Vörunúmer	L/min	Síun (µm)
AF20P-060S	FILTERELEMENT AF/AW20	5µm
AF30P-060S	FILTERELEMENT AF/AW30	5µm
AF40P-060S	FILTERELEMENT AF/AW40	5µm



Filter - AFD - AFM

Vörunúmer	L/min	Síun (µm)
AFD20P-060AS	AFD20-0,01µm	
AFD30P-060AS	AFD30-0,01µm	
AFD40P-060AS	AFD40-0,01µm	
AFM20P-060AS	AFM20-0,3µm	
AFM40P-060AS	AFM40-0,3µm	



Finsía - 1 mikron

Vörunúmer	L/min	Síun (µm)
AFF-EL11B	Síuelement í AFF11B3my	
AFF-EL4B	Síuelement í AFF4B3my	
AFF-EL8B	Síuelement í AFF11B3my	



Síuelement

Vörunúmer	Gerð	L/min
AM-EL250	Síuelement í EAM250	0,3 mik
AM-EL350	Síuelement í EAM350	0,3mik
AM-EL450	Síuelement í EAM450	0,3 mik



Loftdempari

Vörunúmer	Gerð	L/min
AMC320-03	tekur olíu úr loftinu	3/8inn
AMC520-F04	3/4 inn gengjur	
AMC520-F06	3/4 inn gengjur	



Síuelement

Vörunúmer	Gerð	L/min
AMD-EL250	Síuelement í EAMD250	0,01mik
AMD-EL350	Síuelement í EAMD350	0,01 mik
AMD-EL450	Síuelement í EAMD450	0,01 mik
AMD-EL550	Síuelement í EAMD550	0,01 mik



Síuelement

Vörunúmer	Gerð	L/min
AMJ-EL4000	Síuelement í EAJ 4000	



Síuelement

Vörunúmer	Gerð	L/min
AMG-EL350	Síuelement í EAMG350	
AMG-EL450	Síuelement í EAMG450	



Síuelement

Vörunúmer	Gerð	L/min
AMH-EL450	Síuelement í AMH450	



Áltjakkur

Vörunúmer	Gerð	L/min
CD85N16-160C-B	Áltjakkur 16/160 m/endarbremsum	
CD85N16-40CB	Áltjakkur 16/40 m/endarbremsum	
CD85N16-50C-B	Áltjakkur 16/50 m/endarbremsum	
CD85N16-80C-B	Áltjakkur 16/80 m/endarbremsum	
CD85N20-100C-B	áltjakkur 20/100	
CD85N20-125C-B	áltjakkur 20/125	
CD85N20-35C-B	með endabremst 20/35	
CD85N25-080C-B-XC6	Áltjakkur 25/80 með ryðfriri stöng	
CD85N25-100C-B-XC6	Áltjakkur 25/100 með ryðfriri stöng	
CD85N25-125C-B	25/125 m/endarbremsu	
CD85N25-125C-B-XC6B	Áltjakkur 25/125 með ryðfriri stöng	
CD85N25-160C-B	Áltjakkur 25/160 m/loftdempun	
CD85N25-160C-B-XC6	Áltjakkur 25/160 með ryðfriri stöng	
CD85N25-160C-B-XC6B	Áltjakkur 25/160 með ryðfriri stöng	
CD85N25-180C-B-XC6B	Áltjakkur 25/180 með ryðfriri stöng	
CD85N25-200C-B	Áltjakkur ISO 25/200 m/loftdempun	
CD85N25-200C-B-XC6	Áltjakkur 25/200 með ryðfriri stöng	
CD85N25-200C-B-XC6B	Áltjakkur 25/200 með ryðfriri stöng	
CD85N25-250C-B-XC6B	Áltjakkur 25/250 með ryðfriri stöng	
CD85N25-25C-B-XC6	Áltjakkur 25/25 með ryðfriri stöng	
CD85N25-25C-B-XC6B	Áltjakkur 25/25 með ryðfriri stöng	
CD85N25-300C-B-XC6	Áltjakkur 25/300 með ryðfriri stöng	
CD85N25-360C-B-X2018	Áltjakkur 25/360	
CD85N25-500C-B-XC6	Áltjakkur 25/500 með ryðfriri stöng	
CD85N25-50C-B-XC6	Áltjakkur 25/50 með ryðfriri stöng	
CD85N25-80C-B-XC6B	Áltjakkur 25/80 með ryðfriri stöng	
CDG1BA32-117+20-XC10	SMC áltjakkur tvískiptur	
CDG1BA32-120	SMC áltjakkur	
CDG1BA32-50	SMC áltjakkur 32/50	
CDG1BA32-50-XC6	SMC áltjakkur 32x50	
CDG1BN25-150	SMC áltjakkur 25/150	
CDG1BN25-300	SMC áltjakkur 25/300	
CDJ2B16-45-B	Áltjakkur 16/45	
CDJ2B16-45S-B	Áltjakkur 16/45	
CDJ2KF16-125Z-M9BLSA	Áltjakkur	
CDJP2B10-10D	Áltjakkur	
CDJP2B16-20D	Áltjakkur 16/20	
CDJP2B16-25D	Áltjakkur 16/25	
CDJPB15-20D	Áltjakkur	
CG1BA80-250	Áltjakkur 80/250	
CG1KTN25-50Z	Áltjakkur 25-50 non - rotating	
CP95SDB100-320	Álsegtljakkur 100/320	
CP95SDB32-100	Álsegtljakkur 32/100	
CP95SDB32-160	Álsegtljakkur 32/160	
CP95SDB32-25	Álsegtljakkur 32/25	
CP95SDB32-50	Álsegtljakkur 32/50	
CP95SDB40-320	Álsegtljakkur 40/320	
CP95SDB63-300XC6	63/300 með ryðfriri stöng	
CP95SDB63-550	Álsegtljakkur 63/550	
CP96SDB32-135	Álsegtljakkur 32/135	
CP96SDB32-450C	Álsegtljakkur 32/450	
CP96SDB32-60	Álsegtljakkur 32/60	



Álofttjakkur

Vörunúmer	Gerð	L/min
CD76E32-160C-B-XC6B	32/160 með ryðfriri stöng	
CD85N20-050C-B-XC6B	20/50 með ryðfriri stöng	
CD85N20-100C-B-XC6B	20/100 með ryðfriri stöng	
CD85N20-200C-B-XC6B	20/200 með ryðfriri stöng	
CD85N20-250C-B-XC6B	20/250 með ryðfriri stöng	
CD85N25-0025-DKM1088	25/25 með firkant stöng	

Tjakkur - ryðfrí

Vörunúmer	Gerð	L/min
C5G25-0080-DKK11332	25/080 með FKM pakn	
C5G25-DK110184-025	25/25 með FKM pakn	
C5G25-DK110184-050	25/50 með FKM pakn.	
C5G25-DK110184-080	25/080 með FKM pakn	
C5G25-DK110184-100	25/100 með FKM pakn	
C5G25-DK110184-160	25/160 með FKM pakn	
C5G25-DK110184-200	25/200 með FKM pakn	
C85N20-150-DK110377	með endabremst 20/150	
CDG5BA-20-SR-35	Tjakkur ryðfrír 20/35	
CDG5BA-20-SR-50	Tjakkur ryðfrír 20/50	
CDG5BA25SR-050	SMC ryðfr. tjakkur 25/50	
CDG5BA25SR-100	SMC ryðfr. tjakkur 25/100	
CDG5BA32SR-160	Tjakkur ryðfrír 32/160	
CDG5BA32SR-50	Tjakkur ryðfrír 32/50	
CDG5BA32TFSV-100	Tjakkur ryðfrír 32/100 m/gat i enda	
CDG5BA32TFSV-50	Tjakkur ryðfrír 32/50 m/gat i enda	
CDG5BA40SR-350	SMC ryðfr. tjakkur 40/350	
CDG5BA40SR-400	Tjakkur ryðfrír 40/400	
CDG5BA40SR-500	SMC ryðfr. tjakkur 40/500	
CDG5BA40SR-80	Ryðfrír tjakkur 40/80	
CDG5BA40TFSR-400	Tjakkur ryðfrír 40/400 m/gat i enda	
CDG5BA50SR-125	SMC ryðfr. tjakkur 50/125	
CDG5BA50SR-150	SCM ryðfr. tjakkur 50/150	
CDG5BA50SR-160	SMC ryðfr. tjakkur 50/160	
CDG5BA50SR-300	tjakkur ryðfrír 50/300	
CDG5BA50SR-400	Tjakkur ryðfrír 50/400	
CDG5BA50SR-450	Tjakkur ryðfrír 50/450	
CDG5BA63SR-250	Ryðfrír tjakkur 63/250	
CDG5BA63SR-450	Ryðfrír tjakkur 63/450	
CDG5BN80SR-900	Ryðfrirtjakkur m/seg. 80/900	
CDG5E25SV-0050X1833A	Tjakkur ryðfrír 25-50 FKM Skraber	
CDG5E25SV-050-X1833A	SMC ryðfr. tjakkur 25/50	
CDG5EA25SR-250	Tjakkur ryðfrír 25/250 m/gat i enda	
CDG5EA32SR-50	Tjakkur ryðfrír 32/50 m/gat i enda	
CDG5EA32TFSR-50	Tjakkur ryðfrír 32/50 m/gat i enda	
CDG5EN20SR-50	20/50 með ISO enda	
CDG5EN20SV-50	20/50 með ISO enda	
CDG5EN25SR-100	25/100 ISO bakendi	
CDG5EN25SR-160	25/160 ISO endi NBR	
CDG5EN25SR-25	25/25 ISO endi NBR	
CDG5EN25SR-50	25/50 ISO endi NBR	
CDG5EN25SR-80	25/80 ISO endi NBR	
CDG5EN25SV-160	25/160 ISO endi Vito	
CDG5EN25SV-25	25/25 ISO endi Viton	
CDG5EN25SV-50	25/50 ISO endi Viton	
CDG5EN25SV-80	25/80 ISO endi Viton	
CG5BA-20-SR-35	Tjakkur ryðfrír 20/35	
CG5BA-20-SR-50	Tjakkur ryðfrír 20/50	
CG5BA32SR-125	Ryðfrír tjakkur 32/125	
CG5BA32SR-160	Tjakkur ryðfrír 32/160 án/segun	
CG5BA32SR-400-EUH120	Tjakkur ryðfrír 32/400	
CG5BA63-350	Tjakkur ryðfrír 63/350	
CG5BN80SR-900	Ryðfrirtjakkur án seg. 80/900	
CG5EA32SV-50	Ryðfrír tjakkur 32/50	
CG5EA40TNSV-150	Ryðfrír tjakkur 40-150	
CG5EA40TNSV-450	Ryðfrír tjakkur 40-450	
CG5EN25SV-30	Tjakkur ryðfrír 25/30	

Segultjakkur

Vörunúmer	Gerð	L/min
CD85N25-500-B	Segultjakkur 25/500 án endabr,	
CD85N25-500C-B	Segultjakkur 25/500 með endabr	
CY1B63H-1380	Segultjakkur 63/1380	
CY3B32-600	Segultjakkur 32/600	
CY3B32TF-1300	Segultjakkur 32/1300	
CY3B40TF-600	Segultjakkur 40/600	
CY3B40TF-900	Segultjakkur 40/900	

Lofttjakkur - ryðfrí

Vörunúmer	Gerð	L/min
CD85N25-50C-B-XC6B	25/50 með ryðfriri stöng	
CDG5BA25SV-125	25/125	
CDG5EA25SR-50	25/50 m/gat i enda	
CDG5EA40TFSV-200	40/200	
CDG5FN40TFV200G5BAL	40/200	
CG1WBA32-50Z-XC6	Lofttjakkur 32/50	
CG5BA32SR-100-EUH120	Lofttjakkur 32/100	
CG5BA32SR-50-EUH1209	Lofttjakkur 32/50	
CJ2B16-150Z	Lofttjakkur 16/150	
CJ2D16-60	Lofttjakkur 16/60	
CJ2L16-60-DAL00087	Lofttjakkur 16/60 USA	

Lofttjakkur

Vörunúmer	Gerð	L/min
C7640-SBJ002-25	40/25	
C8516-040C	16/40mm	
CD85N16-35C-B	16/35 m/endarbremsum	
	<i>RYÐFRÍR</i>	
C85KN25-200-XC6A	25/200 m/ál endum	
CD85N25-80C-B	ál enda 25/80	

Compacttjakkur

Vörunúmer	Gerð	L/min
CDBQ2B100-100DC-RL	með lokun 100mm	
CDQ2B12-10D	SMC compact tjakkur 12/10 D	
CDQ2B12-15DZ	SMC compact tjakkur 12/15 DZ	
CDQ2B20-10DZ	SMC compact tjakkur 20/10 DZ	
CDQ2B20-15DZ	SMC compact tjakkur 20/15	
CDQ2B20-20D	SMC compact tjakkur 20/20 D	
CDQ2B20-20DZ	20/20 DZ	
CDQ2B20-50DZ	20/50 DZ	
CDQ2B32-50D	32/50 D	
CDQ2B32TF-50DZ	32/50 D	
CDQ2B40TF-20DZ	40/20 DZ	
CDQ2B63TF-20DZ	63/20	
CDQ2WB25-40DZ	25/40 stöng í gegnum	
CDQMB16-5	16/05	
CDQSB16-100DC-X691	16/100	
CDQSWL12-10D-M9BWVZS	12/10 stöng í gegnum	
CDUW16-10D-M9BWZS	16/10 stöng í gegnum	
CQ2A12-5S	Compact tjakkur SMC 12/5	
CQ2B-25-40D	Kompakt tjakkur 25/40	
CQ2B16-20D	SMC compact tjakkur 16/20	
CQ2B16-25D	SMC compact tjakkur 16/25	
CQ2B20-20D	Kompakt tjakkur 20/20	
CQ2B20-45DCM	Kompakt tjakkur 20/45	
CQ2B20-5D	Kompakt tjakkur 20/5	
CQ2B25-20DCM	Kompakt tjakkur 25/20	
CQ2B25-20DM	Kompakt tjakkur 25/20	
CQ2B25-35DC	Kompakt tjakkur 25/35 m. gúmmidempun	
CQ2B25-35DCM	Kompakt tjakkur 25/35 m/loftdempun	
CQ2B32-5D	Kompakt tjakkur 32/5	
CQ2B40-10SZ	Kompakt tjakkur 40/10	
CQ2B50-45DZ	Kompakt tjakkur 50/45	
CQ2B80-46D	SMC kompakt tjakkur 80/46	
CQM32TF-45	SMC kompakt tjakkur 32/45	
CQSB12-10D	SMC kompakt tjakkur 12/10	
CQSB12-15D	SMC kompakt tjakkur 12/15	
CQSB12-5D	SMC kompakt tjakkur 12/5	
ECQD-2B-40-30D	Kompakt tjakkur 40/30	
ECQDQ2B32-50D	SMC kompakt tjakkur 32/50	
ECQDQ2WB63-40D	Kompakt tjakkur gengjum 63/40	
ECQ2B32-15D	SMC kompakt tjakkur 32/15	
ECQ2B32-50D-C	Compact tjakkur 32/50	
ECQ2B40-10D	SMC kompakt tjakkur 40/10	
ECQ2B80-50D	Compact tjakkur 80/50	
ECQ2B80-80D	Compact tjakkur 80/80	



Áltjakkur

Vörunúmer	Gerð	L/min
C92SDB125-160	SMC tjakkur	
C92SDB125-750	Áltjakkur 125/750	
C95SDB125-750	Áltjakkur 125/750	
C95SDB160-0600	Áltjakkur 160 /0600	
C96SDB80-320C	Áltjakkur 80/320 SMC	

CD5G25-300-DKK11533	Tjakkur ryðfrír 25/300 með magnet	
CD85KN-200-B-M9BAXC6	Tjakkur Snýst ekki 25/200	
CD85KN25-50-B	Tjakkur Snýst ekki 25/50	
CD85N10-140-B	SMC tjakkur 10/140 iso 6432	
CD85N10-40-B	Tjakkur 10/40	
CD85N10-40C-B	Tjakkur 10/40 m/endabremsum	
CD85N16-220-B	16/220 iso 6432	
CD85N16-25C-B	Tjakkur 16/25 m/endabremsum	
CD85N20-50C-B	Tjakkur m/endabr. 20/50	
CD85N25-100C-B	Tjakkur m/endabr. 25/100	
CD85N25-25C-B	Tjakkur m/endabr 25/25	
CD85N25-300C-B	Tjakkur m/endabr 25/300	
CD85N25-350C-B	tjakkur m/endabr 25/350	
CD85N25-50C-B	Tjakkur m/endabr 25/50	
CD85N25-550C-B	tjakkur m/endabr 25/550	
CD85N25-550CB-XC6Y14	tjakkur m/endabr 25/550	
CDG1BN25-50	Tjakkur 25/50 sivalur án/endab	
CDG1BN50-100	Tjakkur 50/100 sivalur án/endab	
CDG1BN25-50	Tjakkur 25/50 sivalur án/endab	
CDG1BN50-100	Tjakkur 50/100 sivalur án/endab	
CDJ2B16-50-B	16/50 einvirkur	
CJ1B4-20SU4	Tjakkur 4/20 einvirkur m/gorm	
CJ2B16-30SZ	Tjakkur 16mm	
CM2B32-80AZ	Tjakkur 32-80mm gúmmi demp	
CM2B40-70	Tjakkur 40-70mm gúmmi demp	
CM2L32-100TZ	Tjakkur 32-100 einv	
CQ2WB25-10D	Tjakkur 25/10 gegnumgangandi	
CQ2WB25-40D	Tjakkur 25/40 gegnumgangandi	



Lofttjakkur

Vörunúmer	Gerð	L/min
C7640-SBJ002-25	40/25	
C8516-040C	16/40mm	
	RYÐFRÍR	
C85KN25-200-XC6A	25/200 m/ál endum	
C85N16-040C-DK11411	16/40 FKM-pak pfté ryð stöng	
C85N16-80C	16-80mm	
C85N16-80T	16-80mm	
C85N25-025-DKK11428	25/25 FKM-pak pfté ryð stöng	
C85N25-050-DKK11428	25/50 FKM-pak pfté ryð stöng	
C85N25-080-DKK11428	25/80 FKM-pak pfté ryð stöng	
C85N25-100-DKK11428	25/100 FKM-pak pfté ryð stöng	
C85N25-160-DKK11428	25/160 FKM-pak pfté ryð stöng	
C85N25-200-DKK11428	25/200 FKM-pak pfté ryð stöng	
C85N25-250-DKK11428	25/250 FKM-pak pfté ryð stöng	
C85N25-50	ISO tjakkur 25/50 án endabr.	
C85N25-DCG2689G-50-Y	25/50 með pfté pakningum	



Tjakkur

Vörunúmer	Gerð	L/min
C85N20-150-DK110377	Ryðfrír með endabremst 20/150	

AUKAHLUTIR



Skinna

Vörunúmer	Gerð	L/min
AXT100-DR-5	Skinna fyrir SQ	
AXT100-DR-8	Skinna fyrir SQ	



Kapall

Vörunúmer	Gerð	L/min
AXT100-FC20-3	Kapall 3m SV2000	
AXT100-MC26-030	Kapall F/ISV3000 IP67	

Undirplata

Vörunúmer	Gerð	L/min
AXT502-1A-A03F-L	Undirplata	

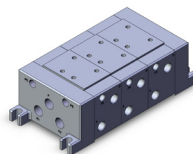

Endaplata

Vörunúmer	Gerð	L/min
AXT502-LA-03F	Endaplata f/ISO Botna	
AXT502-RA-03F	Endaplata f/ISO Botna	



Festing

Vörunúmer	Gerð	L/min
BJ2-016	fyrir skinjara á tjakk	
BJ3-1	fyrir skinjara á tjakk	
BM52	Veggfesting	
BM53	veggfesting	
BM54	Veggfesting	
BM55	f/vatnsskilju AMG550	
BM56	f/vatnsskilju AMG650	

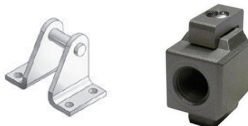

Festing

Vörunúmer	Gerð	L/min
CD-E050SUS	í CG-E050SUS ryðfrír	
CD-E080SUS	í CG-E080SUS festingu	

Boltar

Vörunúmer	Gerð	L/min
AXT502-34-4	Boltar f/botnplötur	



Veggfesting

Vörunúmer	Gerð	L/min
B220	EAR2000, 2500, EAW2000	
B240A	EA/F/L/FM/FD2000	
B320	EAR/EAW3000	
B340A	EA/F/L/FM/FD3000	
B420	EAR/EAW4000	
B440A	EA/F/L/FM/FD 4000	



Festing

Vörunúmer	Gerð	L/min
C5050	SINGLE CLEVIS 50mm	
C5160	SINGLE REAR CLEVIS 160mm	



Gaffall

Vörunúmer	Gerð	L/min
CG-E050SUS	Gaffall f. 50mm ryðfr. tjakk	
CG-E080SUS	Gaffalf. á 80 mm ryðfr. tjakk	



Loftjakkur

Vörunúmer	Gerð
CD55B20-70	20/70mm compact
CD55B63-70	63/70mm compact
CDM2B40-150Z	40/150
CDM2B40-200Z	40/200
CDM2B40-250	40/250



Tjakkur tvöfaldur

Vörunúmer	Gerð
CXSJL15-50	Tjakkur tvöfaldur 15-50
CXSM25-20	Tjakkur tvöfaldur 25-20



Bandtjakkur

Vörunúmer	Gerð
CY1B63H-2200-XB11	Bandtjakkur 63/2200
CY1B63H-2200-XB6B11	Bandtjakkur 63/2200
CY1S40TF-700BZ	Bandtjakkur 40/700
CY3B25-3000-XB11	Bandtjakkur 25/3000
CY3B63TF-2200-XB11	Bandtjakkur 63/2200

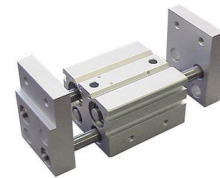

Gripló

Vörunúmer	Gerð
EMHL2-40-D2	Gripló 40mm 200 opnun



Segulskeyfari

Vörunúmer	Gerð
D-B73L	D-B73L
D-F7P	á tjakk SMC
D-M9B	á tjakk SMC IP67
D-M9BL	á tjakk 2 vir SMC 3m snúra
D-M9PAL	á tjakk SMC 3m snúra
D-M9PL	á tjakk SMC 3m snúra
D-Z73	á tjakk SMC



Nemi á tjakk

Vörunúmer	Gerð
D-A93	SMC Nemi á tjakk
D-A93L	SMC Nemi á tjakk
D-A96	SMC Nemi á tjakk
D-B73C	SMC Nemi á tjakk



Samtengi

Vörunúmer	Gerð
DMK6P-04	f/6x4mm slöngu karl
DMK6S-04	f/6x4mm slöngu kerling



Tengistykki

Vörunúmer	Gerð
ELWIKA-KV4408 PVC025	f/ITV0050



Snúningsrótur

Vörunúmer	Gerð
CRA1BS80-90CZ	Snúnings rötur 80/90
CRB1BW20-180S	SMC snúningsrötur 20 / 180°
CRB2BW40-270SZ	SMC snúningsrötur 40-270
CRB2FW10-180S	SMC snúningsrötur 10 / 180°
CDRA1BS80TF-180CZ	Snúningstjakkur 80x180°
CDRQ2BS30-90C	Snúningstjakkur 90°
CDRQ2BS40TF-180C	Snúningstjakkur 40
CRB1BW50-90D-XF	Snúningstjakkur 50 / 90°
ECRB50-270	Snúnings ACTUATOR 50/270
EMSQB30A	Snúningstjakkur 30mm



Pakkingasett

Vörunúmer	Gerð
C85-20PS	i C85 20 mm
C85-25PS	i CD85N25mm tjakk
CG1A32-PS	Pakkingasett i CG1 32 mm
CG1A32-PS	Pakkingasett i CG1 32 mm
CG1N25-PS	Pakkingasett i CG1 25mm
CG1N50-PS	Pakkingasett i CG1 50mm
CG5A100SR-PS	Pakkn. ryöfr.100m/m tja
CG5A25SR-PS	Pakkingasett i CG1 25 mm
CG5A32SR-PS	Pakkn. i SMC ryöfr.32m/m tja
CG5A40SR-PS	Pakkn. i SMC ryöfr.40m/m tja
CG5A50SV-PS	Pakkn. i SMC
CQ2B100-PS	Pakningsett ECQ2B100 tjakk
CQ2B20-PS	Pakningsett tjakkur 20
CQ2B32-XB6-PS	Pakning i CQ2A32
CQ2B40-PS	i compact tjakk 40 mm
CQ2B63-PS	i ECDQ2B63 tjakk
CS92-125	Pakkingasett i tjakk C92
CS95-32	Pakkingasett i tjakk CP95
CS95-63	Pakkingasett i tjakk CP95
CXSL15-K1271-PS	i CXSL15-K1271-PS
CY3B63-PS	i bandtjakk 63mm



Tengistykki

Vörunúmer	Gerð
E200-F02	Tengistykki 1/4" 2000 seria"
E300-F02	tengistykki 1/4" 3000 seria"
E400-F04	tengistykki 1/2" 4000 seria



DOUBLE CLEVIS

Vörunúmer	Gerð
D5050	DOUBLE CLEVIS 50mm
D5160	DOUBLE REAR CLEVIS 160mm



Úrsnarari

Vörunúmer	Gerð
EBAV1R	Úrsnarari

Péttisett

Vörunúmer	Gerð
C92S125-PS	i C92S seriu
C92S80-PS	i C92S 80mm seriu
CG5N32SR-PS	i tjakk ryöfr.ISO

FRL kitt

Vörunúmer	Gerð
EAC-2000-F01DG	FRL kitt (AF+AR+AL) 1/8
EAC-2010-F01DG	FRL kitt (AW+AL) 1/8
EAC-3000-F02DG	FRL kitt (AF+AR+AL) 1/4 auto"
EAC-3010-F02DG	FRL kitt (AW+AL) 1/4 auto dr"



Bakfesting

Vörunúmer	Gerð
CQ-D100	á stubbtjakk 100 mm



Pinnar

Vörunúmer	Gerð
CG-T025	Trunnion Pins 25mm

LOFTLOKAR

LOFTLOKAR - FITTINGS - TJAKKAR



HANDSTÝRÐIR LOFTLOKAR



Endaloki

Vörunúmer	Gerð	Tengingar	Loki
338-955	Endaloki	G1/8	3/2 NC



Endaloki

Vörunúmer	Gerð	Tengingar	Loki
358-955	Endaloki	G1/8	5/2 NC



Loftloki

Vörunúmer	Gerð	Tengingar	Loki
338-D15-9A5	Vélrænt endastopploki	G1/8	3/2 NC



Loftloki

Vörunúmer	Gerð	Tengingar	Loki
338-900	handsýrður án gorms	G1/8	3/2 NC
338-905	handsýrður m/gormi	G1/8	3/2 NC



Loftloki

Vörunúmer	Gerð	Tengingar	Loki
358-900	handstýrður	G1/8	5/2 NC
358-905	handstýrðu - m/gormir	G1/8	5/2 NC

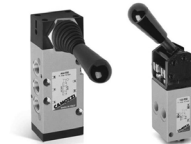

Loftloki

Vörunúmer	Gerð	Tengingar	Loki
338-977	handstýrður	G1/8	3/2 NC



Loftloki - Lokuð miðstöð

Vörunúmer	Gerð	Tengingar	Loki
368-900	Handstýrt - gormalaust	G1/8	5/3 NC
368-905	Handstýrt	G1/8	5/3 NC



Loftloki - Opin miðstöð

Vörunúmer	Gerð	Tengingar	Loki
378-900	Handstýrt - gormalaust	G1/8	5/3
378-905	Handstýrt	G1/8	5/3



Loftloki

Vörunúmer	Gerð	Tengingar	Loki
338-990	handstýrður	G1/8	3/2 NC



Endaloki

Vörunúmer	Gerð	Tengingar	Loki
338-975	m/hnapp	G1/8	3/2 NC



Loftloki

Vörunúmer	Gerð	Tengingar	Loki
338-910	handsýrður	G1/8	3/2 NC
338-915	handsýrður m/gormi	G1/8	3/2 NC
338-913S01	Öryggisloki	G1/8	3/2 NC



Loftloki

Vörunúmer	Gerð	Tengingar	Loki
358-910	handstýrður	G1/8	5/2 NC



Loftloki

Vörunúmer	Gerð	Tengingar	Loki
358-977	handsýrður m/gormi	G1/8	5/2 NC
358-990	handsýrður	G1/8	5/2 NC



Loftloki -

Vörunúmer	Gerð	Tengingar	Loki
338-033	tvöfaldur	G1/8	3/2 NC
338-035	einfaldur m/gormi	G1/8	3/2 NC



Loftloki

Vörunúmer	Gerð	Tengingar	Loki
358-033	tvöfaldur - m/fjóður	G1/8	5/2 NC
358-035	tvöfaldur - m/gormi	G1/8	5/2 NC

LOFTSTÝRÐIR LOFTLOKAR

RAFSTÝRÐIR LOFTLOKAR



Loftloki

Vörunúmer	Gerð	Tengingar	Loki
338L-015-02	rafstýrður - m/fjöður	G1/8	3/2 NC



Loftloki

Vörunúmer	Gerð	Tengingar	Loki
358-E15-02 S03	rafstýrtur - m/fjöður	G1/8	5/2 NC



Loftloki

Vörunúmer	Gerð	Tengingar	Loki
354-015-02	rafstýrtur - m/fjöður	G1/4	5/2 NC
358-015-02	rafstýrtur - m/fjöður	G1/8	5/2 NC
358-015-02IL	rafstýrtur - m/fjöður	G1/8	5/2 NC



Loftloki

Vörunúmer	Gerð	Tengingar	Loki
358-011-02	Tvöfaldur - rafstýrtur	G1/8	3/2 NC



Loftloki - Opin miðstöð

Vörunúmer	Gerð	Tengingar	Loki
374-011-02	Tvöfaldur - rafstýrður	G1/4	5/3 CO
378-011-02	Tvöfaldur - rafstýrður	G1/8	5/3 CO
378-033	Rafstýrður	G1/8	5/3 CO



Loftloki

Vörunúmer	Gerð	Tengingar	Loki
364-011-02	Tvöfaldur - rafstýrður	G1/4	5/3 NC
368-011-02	Tvöfaldur - rafstýrður	G1/8	5/3 NC



Loftloki

Vörunúmer	Gerð	Tengingar	Loki
358-D15-9A5	Vélrænt endastopploki	G1/8	3/2 NC



Raftengi

Vörunúmer	Gerð
122-800	Raftengi miðstærð
124-800	Raftengi stærra



Fótlloki

Vörunúmer	Gerð	Tengingar	Loki
354N-925	Fótlloki	G1/4	5/2 NC

DREIFIKISTUR

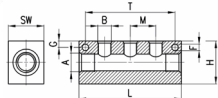

Dreifikista - Lokað

Vörunúmer	Tengi (A)	Tengi (B)
3053 1/2-5L-3/8	1/2	3/8
3053 1/2-6L-3/8	1/2	3/8
3053 1/4-3L-1/8	1/4	1/8
3053 3/8-4L-1/4	3/8	1/4
3053 3/8-5L-1/4	3/8	1/4
3053 3/8-6L-1/4	3/8	1/4

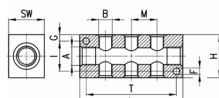

Dreifikista - Opioð

Vörunúmer	Tengi (A)	Tengi (B)
3043 1/2-6D-3/8	1/2	3/8
3043 3/8-3D-1/4	3/8	1/4
3043 3/8-4D-1/4	3/8	1/4
3043 3/8-6D-1/4	3/8	1/4



Nippiltengi

Vörunúmer	Gerð	mm	Ø
S6510-04-1/8	Nippiltengi	4 mm x 1/8"	
S6510-05-1/8	Nippiltengi	5 mm x 1/8"	
S6510-06-1/4	Nippiltengi	6 mm x 1/4"	
S6510-06-1/8	Nippiltengi	6 mm x 1/8"	
S6510-06-3/8	Nippiltengi	6 mm x 3/8"	
S6510-08-1/2	Nippiltengi	8 mm x 1/2"	
S6510-08-1/4	Nippiltengi	8 mm x 1/4"	
S6510-08-1/8	Nippiltengi	8 mm x 1/8"	
S6510-08-3/8	Nippiltengi	8 mm x 3/8"	
S6510-10-1/2	Nippiltengi	10 mm x 1/2"	
S6510-10-1/4	Nippiltengi	10 mm x 1/4"	
S6510-10-3/8	Nippiltengi	10 mm x 3/8"	
S6510-12-1/2	Nippiltengi	12 mm x 1/2"	
S6510-12-1/4	Nippiltengi	12 mm x 1/4"	
S6510-12-3/8	Nippiltengi	12 mm x 3/8"	
S6510-14-1/2	Nippiltengi	14 mm x 1/2"	
S6510-14-3/8	Nippiltengi	14 mm x 3/8"	



Nippiltengi M5

Vörunúmer	Gerð	mm	Ø
6512-04-M5	M5	4 mm	M5
6512-04-M5	M5	5 mm	M5
6512-04-M5	M5	6 mm	M5



Múffutengi

Vörunúmer	Gerð	mm	Ø
6463-04-5M	Múffutengi	4 mm - 5M	
6463-06-1/4	Múffutengi	6 mm - 1/4"	
6463-06-1/8	Múffutengi	6 mm - 1/8"	
6463-08-1/4	Múffutengi	8 mm - 1/4"	
6463-08-1/8	Múffutengi	8 mm - 1/8"	
6463-10-1/4	Múffutengi	10mm - 1/4"	



N-Formúffa

Vörunúmer	Gerð	mm	Ø
S2520-1/4-1/2	N-Formúffa	1/4"-1/2"	
S2520-1/4-1/4	N-Formúffa	1/4"-1/4"	
S2520-1/4-3/8	N-Formúffa	1/4"-3/8"	
S2520-1/8-1/4	N-Formúffa	1/8"-1/4"	
S2520-1/8-1/8	N-Formúffa	1/8"-1/8"	
S2520-1/8-3/8	N-Formúffa	1/8"-3/8"	
S2520-3/8-1/2	N-Formúffa	3/8"-1/2"	
S2520-3/8-3/8	N-Formúffa	3/8"-3/8"	



N-Hólkur

Vörunúmer	Gerð	mm	Ø
S2530-1/2-1/4	N-Hólkur	1/2"-1/4"	
S2530-1/2-1/8	N-Hólkur	1/2"-1/8"	
S2530-1/2-3/8	N-Hólkur	1/2"-3/8"	
S2530-1/4-1/8	N-Hólkur	1/4"-1/8"	
S2530-3/4-1/2	N-Hólkur	3/4"-1/2"	
S2530-3/8-1/4	N-Hólkur	3/8"-1/4"	
S2530-3/8-1/8	N-Hólkur	3/8"-1/8"	



Nippill/múffa

Vörunúmer	Gerð	mm	Ø
2530-3/4-1/2	Nippill/múffa		
2530-3/8-1/4	Nippill/múffa		



Tenginippill

Vörunúmer	Gerð	mm	Ø
S6811-04-1/8	Tenginippill	4mm x 1/8"	
S6811-06-1/4	Tenginippill	6 mm x 1/4"	
S6811-06-1/8	Tenginippill	6 mm x 1/8"	
S6811-08-1/4	Tenginippill	8 mm x 1/4"	
S6811-10-1/4	Tenginippill	10 mm x 1/4"	



Brjóstnippill

Vörunúmer	Gerð	mm	Ø
S2510-1/2-3/4	Brjóstnippill	1/2"-3/4"	
S2510-1/4-1/2	Brjóstnippill	1/4"-1/2"	
S2510-1/4-3/8	Brjóstnippill	1/4"-3/8"	
S2510-1/8-1/4	Brjóstnippill	1/8"-1/4"	
S2510-1/8-3/8	Brjóstnippill	1/8"-3/8"	
S2510-3/8-1/2	Brjóstnippill	3/8"-1/2"	



Brjóstnippill

Vörunúmer	Gerð	mm	Ø
S2500-1/2	Brjóstnippill	1/2"	
S2500-1/4	Brjóstnippill	1/4"	
S2500-1/8	Brjóstnippill	1/8"	
S2500-3/4	Brjóstnippill	3/4"	
S2500-3/8	Brjóstnippill	3/8"	



Millistykki

Vörunúmer	Gerð	mm	Ø
6950-06	Millistykki	6 mm	
6950-08	Millistykki	8 mm	
6950-10	Millistykki	10 mm	
6950-12	Millistykki	12 mm	



Gegnumtak

Vörunúmer	Gerð	mm	mm
6590-06	Gegnumtak	6 mm	
6590-08	Gegnumtak	8 mm	
6590-10	Gegnumtak	10 mm	
6590-12	Gegnumtak	12 mm	



Gegnumtak

Vörunúmer	Gerð	mm	mm
6593 10-3/8	Gegnumtak	10 -	3/8
6593 6-1/4	Gegnumtak	6 -	1/4
6593 6-1/8	Gegnumtak	6 -	1/8
6593 8-1/4	Gegnumtak	8 -	1/4
6593 8-1/8	Gegnumtak	8 -	1/8



Einstefnupreng

Vörunúmer	Gerð	mm	Ø
SCU-602-M5	Einstefnupreng.	M5	
SCU-604-1/8	Einstefnupreng.	1/8"	
SCU-606-1/4	Einstefnupreng.	1/4"	
SCU-608-3/8	Einstefnupreng.	3/8"	



Frömlenging

Vörunúmer	Gerð	mm	Ø
2525-1/4-27	Frömlenging	1/4"-27	
2525-1/4-43	Frömlenging	1/4"-43	
2525-1/8-16	Frömlenging	1/8"-16	
2525-1/8-36	Frömlenging	1/8"-36	



Samtengi

Vörunúmer	Gerð	mm
6580-04	Samtengi	4 mm
6580-05	Samtengi	5 mm
6580-06	Samtengi	6 mm
6580-08	Samtengi	8 mm
6580-10	Samtengi	10 mm
6580-12	Samtengi	12 mm
6580-14	Samtengi	14 mm



Samtengi

Vörunúmer	Gerð	mm	mm
6580 10-8	Samtengi	10	i 8 mm
6580 12-10	Samtengi	12	i 10 mm



Minnkun

Vörunúmer	Gerð	mm	Ø
6800-04-06	Minnkun	6/4"	
6800-04-08	Minnkun	8/4"	
6800-05-06	Minnkun	6/5"	
6800-05-08	Minnkun	8/5"	
6800-06-08	Minnkun	8/6"	
6800-06-12	Minnkun	12/6"	
6800-08-12	Minnkun	12/8"	
6800-10-12	Minnkun	12/10"	
6800-10-14	Minnkun	14/10"	
6800-12-14	Minnkun	14/12"	
6800-6-10	Minnkun	10/6"	
6800-8-10	Minnkun	10/8"	



Stækkun

Vörunúmer	Gerð	mm	Ø
6850-06-04	Stækkun	6/4"	
6850-08-06	Stækkun	8/6"	



Hné tengi

Vörunúmer	Gerð	mm	Ø
S6520-04-1/8	Hné	4 mm	x 1/8"
S6520-05-1/8	Hné	5 mm	x 1/8"
S6520-06-1/4	Hné	6 mm	x 1/4"
S6520-06-1/8	Hné	6 mm	x 1/8"
S6520-06-3/8	Hné	6 mm	x 3/8"
S6520-08-1/2	Hné	8 mm	x 1/2"
S6520-08-1/4	Hné	8 mm	x 1/4"
S6520-08-1/8	Hné	8 mm	x 1/8"
S6520-08-3/8	Hné	8 mm	x 3/8"
S6520-10-1/2	Hné	10 mm	x 1/2"
S6520-10-1/4	Hné	10 mm	x 1/4"
S6520-10-3/8	Hné	10 mm	x 3/8"
S6520-12-1/2	Hné	12 mm	x 1/2"
S6520-12-1/4	Hné	12 mm	x 1/4"
S6520-12-3/8	Hné	12 mm	x 3/8"
S6520-14-1/2	Hné	14 mm	x 1/2"



Hné tengi M5

Vörunúmer	Gerð	mm	Ø
6522-04-M5	Hné tengi	4 mm	x M5
6522-05-M5	Hné tengi	5 mm	x M5
6522-06-M5	Hné tengi	6 mm	x M5
6522-06-M6	Hné tengi	6 mm	x M6



Hné tengi

Vörunúmer	Gerð	mm	Ø
S2020-1/2	Hné tengi	1/2" nippill/múffa	
S2020-1/4	Hné tengi	1/4" nippill/múffa	
S2020-1/8	Hné tengi	1/8" nippill/múffa	
S2020-3/8	Hné tengi	3/8" nippill/múffa	



Hné tengi

Vörunúmer	Gerð	mm	Ø
S2010-1/2	Hné tengi	1/2" nippill	
S2010-1/4	Hné tengi	1/4" nippill	
S2010-1/8	Hné tengi	1/8" nippill	
S2010-3/8	Hné tengi	3/8" nippill	



Hné stungið

Vörunúmer	Gerð	mm	Ø
6555-06-06	Hné stungið	6 mm	
6555-08-08	Hné stungið	8 mm	
6555-10-10	Hné stungið	10 mm	
6555-12-12	Hné stungið	12 mm	



Langt snúningshné

Vörunúmer	Gerð	mm	Ø
S6525-06-1/4	Hné langt snú.	6 mm	x 1/4"
S6525-06-1/8	Hné langt snú.	6 mm	x 1/8"
S6525-08-1/4	Hné langt snú.	8 mm	x 1/4"
S6525-08-1/8	Hné langt snú.	8 mm	x 1/8"



Hné tengi

Vörunúmer	Gerð	mm	Ø
6550-04	Hné tengi	4 mm	
6550-05	Hné tengi	5 mm	
6550-06	Hné tengi	6 mm	
6550-08	Hné tengi	8 mm	
6550-10	Hné tengi	10 mm	
6550-12	Hné tengi	12 mm	
6550-14	Hné tengi	14 mm	



Hálfné

Vörunúmer	Gerð	mm	Ø
S6110 6-1/4	Hálfné	6 mm	x 1/4"
S6110 6-1/8	Hálfné	6 mm	x 1/8"
S6110 8-1/4	Hálfné	8 mm	x 1/4"
S6110 8-1/8	Hálfné	8 mm	x 1/8"



Hné tengi

Vörunúmer	Gerð	mm	Ø
2013-1/2	Hné tengi	1/2" múffa	
2013-1/4	Hné tengi	1/4" múffa	
2013-1/8	Hné tengi	1/8" múffa	
2013-3/8	Hné tengi	3/8" múffa	



Slöngustútur

Vörunúmer	Tengingar	mm	Ø
2601 7-1/4	G1/8	7 mm	1/4
2601 7-1/8	G1/8	7 mm	1/8
2601 8-1/8	G1/8	8 mm	1/8
2601 9-1/8	G1/8	9 mm	1/8
2601 9-1/4	G1/4	9 mm	1/4
2601 12-1/4	G1/4	12 mm	1/4
2601 12-1/2	G1/2	12 mm	1/2
2601 4,5-M5	G1/2	4,5 mm	M5

HRAÐTENGI - KÚPLINGAR

Hraðtengi
BSP Male Quick Coupling

Vörunúmer	Gerð	mm	Ø
5051 1/8	kerling m/nippill	G1/8	5
5051 1/4	kerling m/nippill	G1/4	5
5081 1/4	kerling m/nippill	G1/4	7
5081 3/8	kerling m/nippill	G3/8	7
5081 1/2	kerling m/nippill	G1/2	7

Hraðtengi
BSP Male Quick Coupling Bulkhead

Vörunúmer	Gerð	mm	Ø
5052 1/8	kerling m/nippill	G1/8	5
5052 1/4	kerling m/nippill	G1/4	5
5082 1/4	kerling m/nippill	G1/4	7

Hraðtengi
BSP Female Quick Coupling

Vörunúmer	Gerð	mm	Ø
5053 1/8	kerling m/nippill	G1/8	5
5053 1/4	kerling m/nippill	G1/4	5
5083 1/4	kerling m/nippill	G1/4	7
5083 3/8	kerling m/nippill	G3/8	7
5083 1/2	kerling m/nippill	G1/2	7

Hraðtengi
Quick Coupling Push-on

Vörunúmer	Gerð	mm	Ø
5054 6/4	kerling m/nippill	6/4	5
5054 8/6	kerling m/nippill	8/6	5
5084 8/6	kerling m/nippill	8/6	7
5084 10/8	kerling m/nippill	10/8	7

Hraðtengi
Quick Coupling Bulkhead Push-on

Vörunúmer	Gerð	mm	Ø
5055 6/4	kerling m/nippill	6/4	5
5055 8/6	kerling m/nippill	8/6	5

Hraðtengi
Quick Coupling Hose Adapter

Vörunúmer	Gerð	mm	Ø
5056 06	kerling m/slöngustút	6	5
5056 09	kerling m/slöngustút	9	5
5086 09	kerling m/slöngustút	9	7
5086 12	kerling m/slöngustút	12	7

Hraðtengi
Quick Coupling Hose Connector

Vörunúmer	Gerð	mm	Ø
5057 6x14	kerling m/nippill	6 x 14	5
5087 6x14	kerling m/nippill	6 x 14	7
5087 8x17	kerling m/nippill	8 x 17	7
5087 10x19	kerling m/nippill	10 x 19	7
5087 13x23	kerling m/nippill	13 x 23	7

Hraðtengi
Quick Coupling with Spring

Vörunúmer	Gerð	mm	Ø
5058 6/4	kerling m/gormi	6/4	5
5058 8/6	kerling m/gormi	8/6	5
5088 8/6	kerling m/gormi	8/6	7
5088 10/8	kerling m/gormi	10/8	7

Hraðtengi
Male Connector

Vörunúmer	Gerð	mm	Ø
5150 1/8	nippill, karl	G1/8	5
5150 1/4	nippill, karl	G1/4	5
5180 1/4	nippill, karl	G1/4	7
5180 3/8	nippill, karl	G3/8	7
5180 1/2	nippill, karl	G1/2	7

Hraðtengi
Female Connector

Vörunúmer	Gerð	mm	Ø
5350 1/8	m/múffu, karl	G1/8	5
5350 1/4	m/múffu, karl	G1/4	5
5380 1/4	m/múffu, karl	G1/4	7
5380 3/8	m/múffu, karl	G3/8	7
5380 1/2	m/múffu, karl	G1/2	7

Hraðtengi
Push-on Connector

Vörunúmer	Gerð	mm	Ø
5450 6/4	kerling m/nippill	6/4	5
5450 8/6	kerling m/nippill	8/6	5
5480 8/6	kerling m/nippill	8/6	7
5480 10/8	kerling m/nippill	10/8	7

Hraðtengi
Quick Coupling with Spring

Vörunúmer	Gerð	mm	Ø
5650 06	karl m/slöngutengi	6	5
5650 09	karl m/slöngutengi	9	5
5680 06	karl m/slöngutengi	6	7
5680 09	karl m/slöngutengi	9	7
5680 12	karl m/slöngutengi	12	7

Hraðtengi
Hose Connector

Vörunúmer	Gerð	mm	Ø
5750 6x14	kerling m/nippill	6 X 14	5
5780 6x14	kerling m/nippill	6 X 14	7
5780 8x17	kerling m/nippill	8 X 17	7
5780 13x23	kerling m/nippill	13 X 23	7

Hraðtengi
Connector with Spring

Vörunúmer	Gerð	mm	Ø
5850 6/4	karl m/gormi	6/4	5
5850 8/6	karl m/gormi	8/6	5
5880 8/6	karl m/gormi	8/6	7
5880 10/8	karl m/gormi	10/8	7



Té tengi

Vörunúmer	Gerð	mm	Ø
6540-04	Té tengi	4 mm	
6540-05	Té tengi	5 mm	
6540-06	Té tengi	6 mm	
6540-08	Té tengi	8 mm	
6540-10	Té tengi	10 mm	
6540-12	Té tengi	12 mm	
6540-14	Té tengi	14 mm	



Té tengi

Vörunúmer	Gerð	mm	*
2003-1/2	Té tengi	1/2" mm	
2003-1/4	Té tengi	1/4" mm	
2003-1/8	Té tengi	1/8" mm	
2003-3/8	Té tengi	3/8" mm	



Té tengi

Vörunúmer	Gerð	mm	Ø
S2050-1/2-1/2	Té tengi	1/2"-1/2"	NNM
S2050-1/4-1/4	Té tengi	1/4"-1/4"	NNM
S2050-1/8-1/8	Té tengi	1/8"-1/8"	NNM
S2050-3/8-3/8	Té tengi	3/8"-3/8"	NNM



Té tengi

Vörunúmer	Gerð	mm	Ø
S2060-1/2-1/2	Té tengi	1/2"-1/2"	MNM
S2060-1/4-1/4	Té tengi	1/4"-1/4"	MNM
S2060-1/8-1/8	Té tengi	1/8"-1/8"	MNM
S2060-3/8-3/8	Té tengi	3/8"-3/8"	MNM



Té tengi

Vörunúmer	Gerð	mm	Ø
S2080-1/2	Té tengi	1/2"	nippill
S2080-1/4	Té tengi	1/4"	nippill
S2080-1/8	Té tengi	1/8"	nippill
S2080-3/8	Té tengi	3/8"	nippill



Té tengi

Vörunúmer	Gerð	mm	Ø
S2090-1/2-1/2	Té tengi	1/2"-1/2"	NMN
S2090-1/4-1/4	Té tengi	1/4"-1/4"	NMN
S2090-1/8-1/8	Té tengi	1/8"-1/8"	NMN
S2090-3/8-3/8	Té tengi	3/8"-3/8"	NMN



Té tengi

Vörunúmer	Gerð	mm	Ø
S6430-06-1/4	Té tengi	6 mm x 1/4"	m/teflon
S6430-06-1/8	Té tengi	6 mm x 1/8"	m/teflon
S6430-08-1/4	Té tengi	8 mm x 1/4"	m/teflon
S6430-08-1/8	Té tengi	8 mm x 1/8"	m/teflon
S6430-08-3/8	Té tengi	8 mm x 3/8"	m/teflon
S6430-10-1/4	Té tengi	10 mm x 1/4"	m/teflon
S6430-12-3/8	Té tengi	12 mm x 3/8"	m/teflon



Té tengi

Vörunúmer	Gerð	mm	Ø
S6440-06-1/8	Té tengi snú.	1/8" x 6mm x 6mm	
S6440-08-1/4	Té tengi snú.	1/4" x 8mm x 8mm	
S6440-08-1/8	Té tengi snú.	1/8" x 8mm x 8mm	
S6440-10-1/4	Té tengi snú.	1/4" x 10mm x 10mm	
S6440-12-3/8	Té tengi snú.	3/8" x 12mm x 12mm	



Kross

Vörunúmer	Gerð	mm	Ø
6600-04	Kross	4 mm.	
6600-05	Kross	5 mm.	
6600-06	Kross	6 mm.	
6600-08	Kross	8 mm.	
6600-10	Kross	10 mm.	
6600-12	Kross	12 mm.	



Té tengi - m/teflon

Vörunúmer	Gerð	mm	Ø
S6430-06-1/4	Té tengi	6 mm x 1/4"	m/teflon
S6430-06-1/8	Té tengi	6 mm x 1/8"	m/teflon
S6430-08-1/4	Té tengi	8 mm x 1/4"	m/teflon
S6430-08-1/8	Té tengi	8 mm x 1/8"	m/teflon
S6430-08-3/8	Té tengi	8 mm x 3/8"	m/teflon
S6430-10-1/4	Té tengi	10 mm x 1/4"	m/teflon
S6430-12-3/8	Té tengi	12 mm x 3/8"	m/teflon



Té tengi - m/teflon

Vörunúmer	Gerð	mm	Ø
6432-4-M5	Té tengi	4 mm x M5	m/teflon
6432-5-M5	Té tengi	5 mm x M5	m/teflon



Té tengi

Vörunúmer	Gerð	mm	Ø
S2070-1/2	Té tengi	1/2"	mm
S2070-1/4	Té tengi	1/4"	MMN
S2070-1/8-1/8	Té tengi	1/8"-1/8"	MMN
S2070-3/8-3/8	Té tengi	3/8"-3/8"	MMN



Kross

Vörunúmer	Gerð	mm	Ø
2033-1/8	Kross	1/8"	



Y-tengi

Vörunúmer	Gerð	mm	Ø
S2040-1/2-1/2	Y-tengi	1/2"-1/2"	karl/kona
S2040-1/4-1/4	Y-tengi	1/4"-1/4"	
S2040-1/8-1/8	Y-tengi	1/8"-1/8"	
S2040-3/8-3/8	Y-tengi	3/8"-3/8"	



Y-tengi

Vörunúmer	Gerð	mm	Ø
6560-04	Y-tengi	4 mm	
6560-06	Y-tengi	6 mm	
6560-08	Y-tengi	8 mm	
6560-10	Y-tengi	10 mm	



Einföld baula

Vörunúmer	Gerð	mm	Ø
6610-04-1/8	Baula einf.	4 mm x 1/8"	
6610-04-M5	Baula einf.	4 mm x 5 mm	
6610-04-M6	Baula einf.	4 mm x M6	
6610-05-1/8	Baula einf.	5 mm x 1/8"	
6610-05-M6	Baula einf.	5 mm x M6	
6610-06-1/4	Baula einf.	6 mm x 1/4"	
6610-06-1/8	Baula einf.	6 mm x 1/8"	
6610-06-M6	Baula einf.	6 mm x M6	
6610-08-1/4	Baula einf.	8 mm x 1/4"	
6610-08-1/8	Baula einf.	8 mm x 1/8"	
6610-08-3/8	Baula einf.	8 mm x 3/8"	
6610-10-1/2	Baula einf.	10 mm x 1/2"	
6610-10-1/4	Baula einf.	10 mm x 1/4"	
6610-10-3/8	Baula einf.	10 mm x 3/8"	
6610-12-1/2	Baula einf.	12 mm x 1/2"	



Baula

Vörunúmer	Gerð	mm	Ø
2023-1/4-1/4	Baula	1/4"	
2023-3/8-3/8	Baula	3/8"	

Nippill/múffa

Vörunúmer	Gerð	mm	Ø
2531 1/8-M5	Nippilhólkur	1/8-M5	
2531-3/8-1/4	Nippill/múffa		

Tappi

Vörunúmer	Gerð	mm	Ø
S2610-1/2	Tappi	1/2" f/sekkant	
S2610-1/4	Tappi	1/4" f/sekkant	
S2610-1/8	Tappi	1/8" f/sekkant	
S2610-3/8	Tappi	3/8" f/sekkant	

Tappi

Vörunúmer	Gerð	mm	Ø
2611-1/2	Tappi	1/2"	
2611-1/4	Tappi	1/4"	
2611-1/8	Tappi	1/8"	
2611-3/8	Tappi	3/8"	

Tappi

Vörunúmer	Gerð	mm	Ø
6900-04	Tappi	4 mm	
6900-06	Tappi	6 mm	
6900-08	Tappi	8 mm	
6900-10	Tappi	10 mm	
6900-12	Tappi	12 mm	
6900-14	Tappi	14 mm	

Lok

Vörunúmer	Gerð	mm	Ø
6750-06	Lok	6 mm	
6750-08	Lok	8 mm	
6750-10	Lok	10 mm	

Hljóðdeyfir

Vörunúmer	Gerð	mm	Ø
2901-1/2	Hljóðdeyfir stálret		
2901-1/4-17	Hljóðdeyfir 1/4		
2901-1/8	Hljóðdeyfir 1/8"		
2901-3/4	Hljóðdeyfir stálret 3/4		
2901-3/8	Hljóðdeyfir stálret		
2901-5m	Hljóðdeyfir 5m		

Hljóðdeyfir

Vörunúmer	Gerð	mm	Ø
2938-M5	Hljóðdeyfir		M5

Hljóðdeyfir

Vörunúmer	Gerð	mm	Ø
2931-1/2	Hljóðdeyfir kopar		1/2
2931-1/4	Hljóðdeyfir kopar		1/4
2931-1/8	Hljóðdeyfir kopar		1/8
2931-3/8	Hljóðdeyfir kopar		3/8

Þétting

Vörunúmer	Gerð	mm	Ø
6708-6	Þétting á fittings	6 mm	
6708-8	Þétting á fittings	8 mm	
6708-10	Þétting á fittings	10 mm	

Nippilhné

Vörunúmer	Gerð	mm	"
7522 4-1/4	Nippilhné	4	- 1/4"
7522 4-1/8	Nippilhné	4	- 1/8"
7522 6-1/4	Nippilhné	6	- 1/4"
7522 6-1/8	Nippilhné	6	- 1/8"
7522 8-1/4	Nippilhné	8	- 1/4"
7522 8-1/8	Nippilhné	8	- 1/8"

Nippilhné langt

Vörunúmer	Gerð	mm	"
7526 4-1/8	Nippilhné langt	4	- 1/8
7526 6-1/4	Nippilhné langt	6	- 1/4
7526 6-1/8	Nippilhné langt	6	- 1/8
7526 8-1/4	Nippilhné langt	8	- 1/4
7526 8-1/8	Nippilhné langt	8	- 1/8

Hné stungið

Vörunúmer	Gerð	mm	efni
7555-12-12	Hné stungið	12mm	plast

Samtengi

Vörunúmer	Gerð	mm	efni
7580 8	Samtengi	8 mm	plast

Einstefnupreng

Vörunúmer	Gerð	mm	Ø
PSCU 604-1/8-6	Einstefnupreng,06-1/8		
PSCU 604-1/8-8	Einstefnupreng,08-1/8		
PSCU 606-1/4-6	Einstefnupreng,06-1/4		
PSCU 606-1/4-8	Einstefnupreng,08-1/4		

Prenging

Vörunúmer	Gerð	mm	Ø
7622 6-1/4	Prenging 6-1/4 plast		
7622 6-1/8	Prenging 6-1/8 plast		
7622 8-1/4	Prenging 8-1/4 plast		

Y-tengi

Vörunúmer	Gerð	mm	"
7575 8-6	Y-tengi	m/4 útgang	

Banjo

Vörunúmer	Gerð	mm	"
7642-02-06-1/4	Banjo 4x tvöfalt	6mm	1/4"
7642-03-06-1/4	Banjo 3x tvöfalt	6mm	1/4"
7642-03-06-1/8	Banjo 3x tvöfalt	6mm	1/8"
7642-03-08-1/4	Banjo 3x tvöfalt	8mm	1/4"
7642-03-08-1/8	Banjo 3x tvöfalt	8mm	1/8"
7642-03-10-1/4	Banjo 3x tvöfalt	10mm	1/4"

Deilistykki

Vörunúmer	Gerð	mm	Ø
7545 10-8	Deilistykki	10-8 / 8 útgang	
7545 6-4	Deilistykki	6-4 / 4 útgang	
7545 8-6	Deilistykki	8-6 / 6 útgang	

Einstefnupreng

Vörunúmer	Gerð	mm	Ø
RFU-446-1/4	Einstefnupreng.	1/4	
RFU-482-1/8	Einstefnupreng.	1/8	

Prengingarloki

Vörunúmer	Gerð	mm	Ø
RFO-346-1/4	Prengingarloki	1/4	
RFO-383-1/8	Prengingarloki	1/8	



Tjakkur

Vörunúmer	Magnetic	Virkni	(Ø)	Slaglengd
25N2A20A010	Já	tvivirkur	20	10
25N2A20A025	Já	tvivirkur	20	25
25N2A20A050	Já	tvivirkur	20	50
25N2A20A080	Já	tvivirkur	20	80
25N2A20A100	Já	tvivirkur	20	100
25N2A20A160	Já	tvivirkur	20	160
25N2A20A200	Já	tvivirkur	20	200
25N2A20A250	Já	tvivirkur	20	250
25N2A20A300	Já	tvivirkur	20	300
25N2A20A320	Já	tvivirkur	20	320
25N2A20A400	Já	tvivirkur	20	400
25N2A20A500	Já	tvivirkur	20	500

25N2A25A010	Já	tvivirkur	25	10
25N2A25A025	Já	tvivirkur	25	25
25N2A25A040	Já	tvivirkur	25	40
25N2A25A050	Já	tvivirkur	25	50
25N2A25A080	Já	tvivirkur	25	80
25N2A25A100	Já	tvivirkur	25	100
25N2A25A125	Já	tvivirkur	25	125
25N2A25A160	Já	tvivirkur	25	160
25N2A25A200	Já	tvivirkur	25	200
25N2A25A250	Já	tvivirkur	25	250
25N2A25A300	Já	tvivirkur	25	300
25N2A25A320	Já	tvivirkur	25	320
25N2A25A400	Já	tvivirkur	25	400
25N2A25A500	Já	tvivirkur	25	500

Tjakkur

Vörunúmer	Gerð	Virkni	(Ø)	Slaglengd
61M5P080xxxxx	off. standard	tvivirkur	80	1500

▶ sjá fleiri tjakkur á www.camozzi.com/Search

VERKFÆRI



Slönguklippur

Vörunúmer	Gerð	mm
PNZ-12	Slönguklippur	0-12mm
PNZ-25	Slönguklippur	0-25mm



Slönguklippur

Vörunúmer	Gerð	mm
PNZP-12	Slönguklippur	plast



Lylklar

Vörunúmer	Gerð	mm
SP	Lylklar til að aftengja slöngur	

TJAKKAR

INOX
PNEUMATIC



Lofttjakkur - ryðfrír

Vörunúmer	mm - Ø
CS03203JB0050	32/50
CS03203JB0080	32/80
CS03203JB0100	32/100
CS03203JB0100M	32/100
CS03203JB0125	32/125
CS03203JB0160	32/160
CS03203JB0200	32/200
CS03203JB0250	32/250



Lofttjakkur - ryðfrír

Vörunúmer	mm - Ø	gerð
T03203JB0025M	32/25	með gati í enda
T03203JB0050M	32/50 (segull)	m/gengj
T03203JB0080M	32/80 (segull)	m/gengj
T03203JB0125M	32/125	m/gengj
T03203JB0100M	32/100	m/gengj
T03203JB0160M	32/160 (segull)	m/gengj
T03203JB0200M	32/200	m/gengj
T03203JB0250M	32/250 (segull)	m/gengj



Tjakkur - ryðfrír - með gengju

Vörunúmer	mm - Ø	gerð
S02503JB0025	25/25	m/gengj
S02503JB0050	25/50	m/gengj
S02503JB0080	25/80	m/gengj
S02503JB0100	25/100	m/gengj
S02503JB0125	25/125	m/gengj
S02503JB0160	25/160	m/gengj
S02503JB0180	25/180	m/gengj
S02503JB0200	25/200	m/gengj
S02503JB0250C	25/250	m/gengj



Tjakkur - ryðfrír - án gengju

Vörunúmer	mm - Ø	lengd	Litur
S02503JB0050CW	25/50	án gengjur	
S02503JB0080CW	25/80	án gengjur	
S02503JB0050CW	25/50	án gengjur	
S02503JB0100CW	25/100	án gengjur	
S02503JB0125CW	25/125	án gengjur	
S02503JB0160CW	25/160	án gengjur	
S02503JB0180CW	25/180	án gengjur	
S02503JB0200CW	25/200	án gengjur	
S02503JB0250CW	25/250	án gengj	



Pakningsett

Vörunúmer	Gerð	mm
PSG01-020	sett f/tjakk	20 mm
PSG01-025	sett f/tjakk	25 mm
PSG01-032	sett f/tjakk	32 mm
PSG01-040	sett f/tjakk	40 mm
PSG01-050	sett f/tjakk	50 mm
PSG01-063	sett f/tjakk	63 mm
PSG01-080	sett f/tjakk	80 mm



Kúluliður - ryðfrír

Vörunúmer	Gerð	mm
SF17016	Ryðfrít	M6 gengur
SF17025/32	Ryðfrít	10x1,25
SF17040	Ryðfrít	12x1,25
SF17050/63	Ryðfrít	16x1,5
SF17080	Ryðfrít	20x1,5



Kúluliður - plast

Vörunúmer	Gerð	mm
SF17016-P	Plast	M6 gengur
SF17025/32-P	Plast	10x1,25
SF17040P	Plast	40 mm 12x1,25
SF17050/63-PA	Plast	16x1,5
SF17080-100-P	Plast	80-100 mm 20x1,5



Loftrótor

Vörunúmer	Gerð	? ???	mm
PA15	tvívirkur	PA10 F05/F07	17
PA15/S	einvirkur	PA/S F05/F07	17



Loftrótor - ryðfrír

Vörunúmer	Gerð	????	mm
PI20	tvívirkur		
PI20S	einvirkur		
PI30S	einvirkur		
PI40S	einvirkur		



Loftrótor - plast

Vörunúmer	Gerð	Stærð mm	mm
PP00	Loftrótor Polyamideplast tvívirkur		
PP00S	Loftrótor plast einvirkur með gorm		
PP10	Loftrótor úr plasti tvívirkur		
PP10/S	Loftrótor úr plasti einvirkur		
PP20	Loftrótor úr plasti tvívirkur		
PP20S	Loftrótor úr plasti einvirkur		



Loftrótor - plast

Vörunúmer	Gerð	Stærð mm	mm
PPW	Loftrótor plast tvív.		
PPWS	Loftrótor plast einvirkur með gorm		



Positioner SMART

Vörunúmer	Gerð	Stærð mm	mm
PST-303	Positioner SMART 4-20 mA P00-P30		
PST-A204D	Positioner SMART 4-20 mA P00-P30		

LOFTMÓTORAR



Sjá allar upplýsingar á <https://globe-benelux.nl/airmotors/en/product-serie/air-vane-motors/>



LOFT- OG RAFMÓTOROR

ROFRÓTORAR - KÚLULOKAR - STÝRINGAR



 valpes

Ótrulegir möguleikar af lokum og rafstýringum



RAFRÓTOR

ER típa IP-65
VS eða VR típa IP-68

KÚLULOKEI

m/gengjum
- ryðfrítt

KÚLULOKEI

m/suðuenda
- ryðfrítt



SPJALDLOKEI

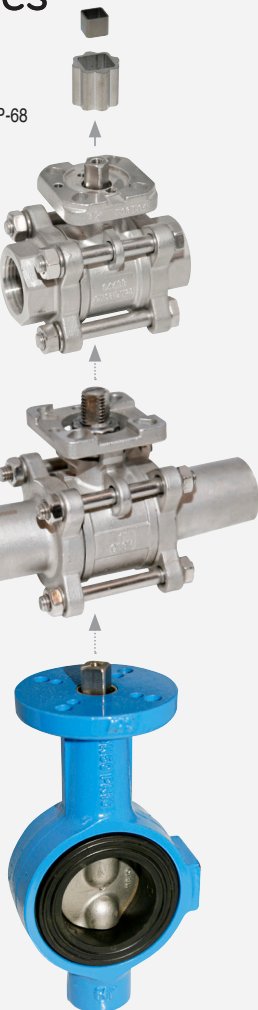

RAFRÓTOR

PVC LOKAR

3 WAY PVC KÚLULOKEI

PVC SPJALDLOKEI



Stöðustillir
4-20 mA

Stöðuskynjari



LOFTRÓTOR

Sjáðu
nánar á
loft.is

KÚLULOKEI

fyrir

- Sjö- og krapalagnir
- Loftlagnir
- Neyslu- vatnslagnir





Rafmagnsrótor - ER20

Vörunúmer	Stjarna / Lengd á milli róa	Tog	Spenna	Kraftur	tími án álags	tími álags
ER20.X03.M00	14/F03-F04-F05	20Nm	24V 50/60Hz (24V DC)	15W	7s	12s
ER20.X0A.M00	14/F03-F04-F05	20Nm	100V to 240V 50/60Hz (100V to 350V DC)	15W	9s	13s
ER20.X3B.GP6	14/F03-F04-F05	20Nm,	15-30VAC/12-48VDC	15W,		25s
ER20.X0A.GF3	14/F03-F04-F05	20Nm	100V - 240V 50/60Hz (100V - 350V DC)	15W	9s	12s
ER20.X3A.GP6	14/F03-F04-F05	20Nm	100-240VAC/100-350VDC	15W,		25s
ER20.X3A.GP6	14/F03-F04-F05	20Nm	100-240VAC/100-350VDC	15W,		25s
ER20.X3A.GP6.U/3020	14 F03/F04/F05	20 Nm	100 V to 240 V 50/60 Hz (100 V to 350 V DC)	15 W	25 s	
ER20.X3A.GP6.U/3020			230v 20Nm Posi Card P6 180°			

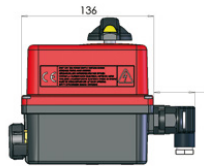
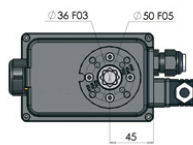
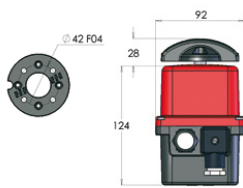

Rafmagnsrótor - ER35

Vörunúmer	Stjarna / Lengd á milli róa	Tog	Spenna	Kraftur	tími án álags	tími álags
ER35.90A.M00	22/F05-F07	35Nm	100V to 240V 50/60Hz (100V to 350V DC)	45W	7s	8s
ER35.903.M00	22/F05-F07	35Nm	24V 50/60Hz (24V DC)	45W	6s	7s
ER35.93A.GP6	22/F05-F07	35Nm	100V to 240V 50/60Hz (100V to 350V DC)	45W	34s	40s
ER35.93B.GP6	22/F05-F07	60Nm	100V to 240V 50/60Hz (100V to 350V DC)	45W	67s	79s

Rafmagnsrótor - ER60

Vörunúmer	Stjarna / Lengd á milli róa	Tog	Spenna	Kraftur	tími án álags	tími álags
ER60.90A.M00	22/F05/F07	60Nm	100 V to 240 V 50/60 Hz (100 V to 350 V DC)	45 W	7s	15 s
ER60.90A.G00	22/F05-F07	60Nm	100V to 240V 50/60Hz (100V to 350V DC)	45W	10s	12s
ER60.93A.GP6	22 / F05-F07	60Nm	100V to 240V 50/60Hz (100V to 350V DC)	45W	67s	79s
ER60.93B.GP6	22 / F05-F07	60Nm	15V to 30V 50/60Hz (12V to 48V DC)	45W	68s 7	9s

Rafmagnsrótor - ER100

Vörunúmer	Stjarna / Lengd á milli róa	Tog	Spenna	Kraftur	tími án álags	tími álags
ER100.90A.M00	22/F05-F07	100Nm	100V to 240V 50/60Hz (100V to 350V DC)	45W	22s	25s
ER100.903.M00	22/F05-F07	100Nm	24V 50/60Hz (24V DC)	45W	18s	22s
ER100.93A.GP6	22 F05/F07	100 Nm	100 V to 240 V 50/60 Hz (100 V to 350 V DC)	45 W	119 s	
ER100.93B.GP6/3020	22 F05/F07	100 Nm	100 V to 240 V 50/60 Hz (100 V to 350 V DC)	45 W	119 s	



Rafmagnsrótor - STANDARD RANGE

Vörunúmer	Stjarna / Lengd á milli róa	Tog	Spenna	Kraftur	tími án álags	tími án álags
ER20.X0A.G00**	14/F03-F04-F05	20Nm	100V - 240V 50/60Hz (100V - 350V DC)	15W	9s	12s
ER20.X0B.G00**	14/F03-F04-F05	20Nm	15V - 30V 50/60Hz (12V - 48V DC)	15W	9s	12s
ER35.X0A.G00**	14/F03-F04-F05	35Nm	100V - 240V 50/60Hz (100V - 350V DC)	15W	19s	26s
ER35.X0B.G00**	14/F03-F04-F05	35Nm	15V - 30V 50/60Hz (12V - 48V DC)	15W	19s	24s
ER35.90A.G00	22/F05-F07	35Nm	100V - 240V 50/60Hz (100V - 350V DC)	45W	6s	7s
ER35.90B.G00	22/F05-F07	35Nm	15V - 30V 50/60Hz (12V - 48V DC)	45W	6s	7s
ER60.90A.G00	22/F05-F07	60Nm	100V - 240V 50/60Hz (100V - 350V DC)	45W	10s	12s
ER60.90B.G00	22/F05-F07	60Nm	15V - 30V 50/60Hz (12V - 48V DC)	45W	10s	12s
ER100.90A.G00	22/F05-F07	100Nm	100V - 240V 50/60Hz (100V - 350V DC)	45W	20s	23s
ER100.90B.G00	22/F05-F07	100Nm	15V - 30V 50/60Hz (12V - 48V DC)	45W	19s	22s

Rafmagnsrótor - LONG OPERATING TIME RANGE

Vörunúmer	Stjarna / Lengd á milli róa	Tog	Spenna	Kraftur	tími án álags	tími án álags
ER35.93A.G00	22/F05-F07	35Nm	100V - 240V 50/60Hz (100V - 350V DC)	45W	34s	40s
ER35.93B.G00	22/F05-F07	35Nm	15V - 30V 50/60Hz (12V - 48V DC)	45W	34s	41s
ER60.93A.G00	22/F05-F07	60Nm	100V - 240V 50/60Hz (100V - 350V DC)	45W	67s	79s
ER60.93B.G00	22/F05-F07	60Nm 1	15V - 30V 50/60Hz (12V - 48V DC)	45W	68s	79s
ER100.93A.G00	22/F05-F07	100Nm	100V - 240V 50/60Hz (100V - 350V DC)	45W	110s	119s
ER100.93B.G00	22/F05-F07	100Nm	15V - 30V 50/60Hz (12V - 48V DC)	45W	110s	119s

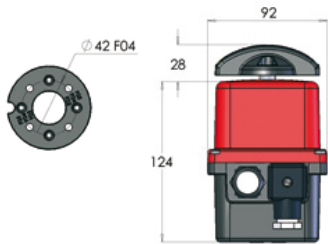

Rafmagnsrótor - STANDARD RANGE

Vörunúmer	Stjarna / Lengd á milli róa	Tog	Spenna	Kraftur	tími án álags	tími án álags
ER10.X0A.GF3**	14/F03-F04-F05	10Nm	100V - 240V 50/60Hz (100V - 350V DC)	15W	9s	11s
ER10.X0B.GF3**	14/F03-F04-F05	10Nm	15V - 30V 50/60Hz (12V - 48V DC)	15W	9s	11s
ER20.X0A.GF3**	14/F03-F04-F05	20Nm	100V - 240V 50/60Hz (100V - 350V DC)	15W	9s	12s
ER20.X0B.GF3**	14/F03-F04-F05	20Nm	15V - 30V 50/60Hz (12V - 48V DC)	15W	9s	12s
ER35.X0A.GF3**	14/F03-F04-F05	35Nm	100V - 240V 50/60Hz (100V - 350V DC)	15W	19s	26s
ER35.X0B.GF3**	14/F03-F04-F05	35Nm	15V - 30V 50/60Hz (12V - 48V DC)	15W	19s	24s
ER35.90A.GF3	22/F05-F07	35Nm	100V - 240V 50/60Hz (100V - 350V DC)	45W	6s	7s
ER35.90B.GF3	22/F05-F07	35Nm	15V - 30V 50/60Hz (12V - 48V DC)	45W	6s	7s
ER60.90A.GF3	22/F05-F07	60Nm	100V - 240V 50/60Hz (100V - 350V DC)	45W	10s	12s
ER60.90B.GF3	22/F05-F07	60Nm	15V - 30V 50/60Hz (12V - 48V DC)	45W	10s	12s
ER100.90A.GF3	22/F05-F07	100Nm	100V - 240V 50/60Hz (100V - 350V DC)	45W	20s	23s
ER100.90B.GF3	22/F05-F07	100Nm	15V - 30V 50/60Hz (12V - 48V DC)	45W	19s	22s

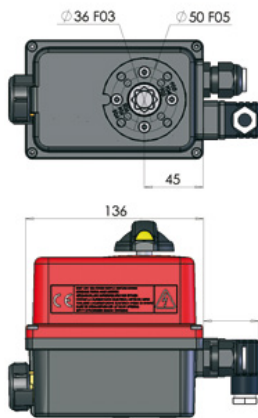

Rafmagnsrótor - LONG OPERATING TIME RANGE

Vörunúmer	Stjarna / Lengd á milli róa	Tog	Spenna	Kraftur	tími án álags	tími án álags
ER35.93A.GF3	22/F05-F07	35Nm	100V - 240V 50/60Hz (100V - 350V DC)	45W	34s	40s
ER35.93B.GF3	22/F05-F07	35Nm	15V - 30V 50/60Hz (12V - 48V DC)	45W	34s	41s
ER60.93A.GF3	22/F05-F07	60Nm	100V - 240V 50/60Hz (100V - 350V DC)	45W	67s	79s
ER60.93B.GF3	22/F05-F07	60Nm	15V - 30V 50/60Hz (12V - 48V DC)	45W	68s	79s
ER100.93A.GF3	22/F05-F07	100Nm	100V - 240V 50/60Hz (100V - 350V DC)	45W	110s	119s
ER100.93B.GF3	22/F05-F07	100Nm	15V - 30V 50/60Hz (12V - 48V DC)	45W	110s	119s

Rafmagnsrótor - STANDARD RANGE

VR 25-45-75 Nm - VS 100-150-300 Nm - VT 600-1000 Nm

Vörunúmer	Stjarna / Lengd á milli róa	Tog	Spenna	Kraftur	tími án álags
VR25.70A.G00	17 F05/F07	25Nm	100V - 240V 50/60Hz (100V - 350V DC)	45W	7s
VR25.70B.G00	17 F05/F07	25Nm	15V - 30V 50/60Hz (12V - 48V DC)	45W	7s
VR45.70A.G00	17 F05/F07	45Nm	100V - 240V 50/60Hz (100V - 350V DC)	45W	15s
VR45.70B.G00	17 F05/F07	45Nm	15V - 30V 50/60Hz (12V - 48V DC)	45W	15s
VR75.70A.G00	17 F05/F07	75Nm	100V - 240V 50/60Hz (100V - 350V DC)	45W	20s
VR75.70B.G00	17 F05/F07	75Nm	15V - 30V 50/60Hz (12V - 48V DC)	45W	20s
VS100.90A.G00	22 F07/F10	100Nm	100V - 240V 50/60Hz (100V - 350V DC)	45W	15s
VS100.90B.G00	22 F07/F10	100Nm	15V - 30V 50/60Hz (12V - 48V DC)	45W	15s
VS150.90A.G00	22 F07/F10	150Nm	100V - 240V 50/60Hz (100V - 350V DC)	45W	30s
VS150.90B.G00	22 F07/F10	150Nm	15V - 30V 50/60Hz (12V - 48V DC)	45W	30s
VS300.90A.G00	22 F07/F10	300Nm	100V - 240V 50/60Hz (100V - 350V DC)	45W	60s
VS300.90B.G00	22 F07/F10	300Nm	15V - 30V 50/60Hz (12V - 48V DC)	45W	60s



Rafmagnsrótor - THREE-PHASE 400V RANGE

VR 25-45-75 Nm - VS 100-150-300 Nm - VT 600-1000 Nm

Vörunúmer	Stjarna / Lengd á milli róa	Tog	Spenna	Kraftur	tími án álags
VR25.709.R00	17 F05/F07	25Nm	400V TRI	20W	10s
VR45.709.R00 17	F05/F07	45Nm	400V TRI	52W	10s
VR75.709.R00 17	F05/F07	75Nm	400V TRI	52W	15s
VS100.909.R00 22	F07/F10	100Nm	400V TRI	135W	10s
VS150.909.R00 22	F07/F10	150Nm	400V TRI	135W	20s
VS300.909.R00 22	F07/F10	300Nm	400V TRI	135W	35s

LOFT- OG RAFMÓTORAR

Rafmagnsrótor - STANDARD RANGE

VR 25-45-75 Nm - VS 100-150-300 Nm VT 600-1000 Nm

Vörunúmer	Stjama / Lengs á milli róa	Tog	Spenna	Kraftur	tími án álags
VR25.70A.G00	17 F05/F07	25Nm	100V - 240V 50/60Hz (100V - 350V DC)	45W	7s
VR25.70B.G00	17 F05/F07	25Nm	15V - 30V 50/60Hz (12V - 48V DC)	45W	7s
VR45.70A.G00	17 F05/F07	45Nm	100V - 240V 50/60Hz (100V - 350V DC)	45W	15s
VR45.70B.G00	17 F05/F07	45Nm	15V - 30V 50/60Hz (12V - 48V DC)	45W	15s
VR75.70A.G00	17 F05/F07	75Nm	100V - 240V 50/60Hz (100V - 350V DC)	45W	20s
VR75.70B.G00	17 F05/F07	75Nm	15V - 30V 50/60Hz (12V - 48V DC)	45W	20s
VS100.90A.G00	22 F07/F10	100Nm	100V - 240V 50/60Hz (100V - 350V DC)	45W	15s
VS100.90B.G00	22 F07/F10	100Nm	15V - 30V 50/60Hz (12V - 48V DC)	45W	15s
VS150.90A.G00	22 F07/F10	150Nm	100V - 240V 50/60Hz (100V - 350V DC)	45W	30s
VS150.90B.G00	22 F07/F10	150Nm	15V - 30V 50/60Hz (12V - 48V DC)	45W	30s
VS300.90A.G00	22 F07/F10	300Nm	100V - 240V 50/60Hz (100V - 350V DC)	45W	60s
VS300.90B.G00	22 F07/F10	300Nm	15V - 30V 50/60Hz (12V - 48V DC)	45W	60s

Rafmagnsrótor - THREE-PHASE 400V RANGE

VR 25-45-75 Nm - VS 100-150-300 Nm VT 600-1000 Nm

Vörunúmer	Stjama / Lengs á milli róa	Tog	Spenna	Kraftur	tími án álags
VR25.709.R00	17 F05/F07	25Nm	400V TRI	20W	10s
VR45.709.R00	17 F05/F07	45Nm	400V TRI	52W	10s
VR75.709.R00	17 F05/F07	75Nm	400V TRI	52W	15s
VS100.909.R00	22 F07/F10	100Nm	400V TRI	135W	10s
VS150.909.R00	22 F07/F10	150Nm 4	00V TRI	135W	20s
VS300.909.R00	22 F07/F10	300Nm	400V TRI	135W	35ss

Rafmagnsrótor - VT RANGE

VR 25-45-75 Nm - VS 100-150-300 Nm VT 600-1000 Nm

Vörunúmer	Stjama / Lengs á milli róa	Tog	Spenna	Kraftur	tími án álags
VT600.A08.T00	36 F10/F12	600Nm	230V AC	250W	38s
VT1000.A08.T00	36 F10/F12	1000Nm	230V AC	250W	38s
VT600.A09.T00	36 F10/F12	600Nm	400V TRI	250W	38s
VT1000.A09.T00	36 F10/F12	1000Nm	400V TRI	250W	38s

Rafmagnsrótor - VR 25-45-75 Nm - VS 100-150-300 Nm

Vörunúmer	Stjama / Lengs á milli róa	Tog	Spenna	Kraftur	tími án álags
VR25.70A.GS2	17 F05/F07	25Nm	100V - 240V 50/60Hz (100V - 350V DC)	45W	7s
VR25.70B.GS2	17 F05/F07	25Nm	15V - 30V 50/60Hz (12V - 48V DC)	45W	7s
VR45.70A.GS2	17 F05/F07	45Nm	100V - 240V 50/60Hz (100V - 350V DC)	45W	15s
VR45.70B.GS2	17 F05/F07	45Nm	15V - 30V 50/60Hz (12V - 48V DC)	45W	15s
VR75.70A.GS2	17 F05/F07	75Nm	100V - 240V 50/60Hz (100V - 350V DC)	45W	20s
VR75.70B.GS2	17 F05/F07	75Nm	15V - 30V 50/60Hz (12V - 48V DC)	45W	20s
VS100.90A.GS2	22 F07/F10	100Nm	100V - 240V 50/60Hz (100V - 350V DC)	45W	15s
VS100.90B.GS2	22 F07/F10	100Nm	15V - 30V 50/60Hz (12V - 48V DC)	45W	15s
VS150.90A.GS2	22 F07/F10	150Nm	100V - 240V 50/60Hz (100V - 350V DC)	45W	30s
VS150.90B.GS2	22 F07/F10	150Nm	15V - 30V 50/60Hz (12V - 48V DC)	45W	30s
VS300.90A.GS2	22 F07/F10	300Nm	100V - 240V 50/60Hz (100V - 350V DC)	45W	60s
VS300.90B.GS2	22 F07/F10	300Nm	15V - 30V 50/60Hz (12V - 48V DC)	45W	60s
VR75.70A.GS2	17 F05/F07	75Nm	100V - 240V 50/60Hz (100V - 350V DC)	45W	20s
VR75.70B.GS2	17 F05/F07	75Nm	15V - 30V 50/60Hz (12V - 48V DC)	45W	20s
VS100.90A.GS2	22 F07/F10	100Nm	100V - 240V 50/60Hz (100V - 350V DC)	45W	15s
VS100.90B.GS2	22 F07/F10	100Nm	15V - 30V 50/60Hz (12V - 48V DC)	45W	15s
VS150.90A.GS2	22 F07/F10	150Nm	100V - 240V 50/60Hz (100V - 350V DC)	45W	30s
VS150.90B.GS2	22 F07/F10	150Nm	15V - 30V 50/60Hz (12V - 48V DC)	45W	30s
VS300.90A.GS2	22 F07/F10	300Nm	100V - 240V 50/60Hz (100V - 350V DC)	45W	60s
VS300.90B.GS2	22 F07/F10	300Nm	15V - 30V 50/60Hz (12V - 48V DC)	45W	60s

Rafmagnsrótor - VR 25-45-75 Nm - VS 100-150-300 Nm

Vörunúmer	Stjama / Lengs á milli róa	Tog	Spenna	Kraftur	tími án álags
VR25.70A.GP5	17 F05/F07	25Nm	100V - 240V 50/60Hz (100V - 350V DC)	45W	7s (15s*)
VR25.70B.GP5	17 F05/F07	25Nm	15V - 30V 50/60Hz (12V - 48V DC)	45W	7s (15s*)
VR45.70A.GP5	17 F05/F07	45Nm	100V - 240V 50/60Hz (100V - 350V DC)	45W	15s
VR45.70B.GP5	17 F05/F07	45Nm	15V - 30V 50/60Hz (12V - 48V DC)	45W	15s
VR75.70A.GP5	17 F05/F07	75Nm	100V - 240V 50/60Hz (100V - 350V DC)	45W	20s
VR75.70B.GP5	17 F05/F07	75Nm	15V - 30V 50/60Hz (12V - 48V DC)	45W	20s
VS100.90A.GP5	22 F07/F10	100Nm	100V - 240V 50/60Hz (100V - 350V DC)	45W	15s
VS100.90B.GP5	22 F07/F10	100Nm	15V - 30V 50/60Hz (12V - 48V DC)	45W	15s
VS150.90A.GP5	22 F07/F10	150Nm	100V - 240V 50/60Hz (100V - 350V DC)	45W	30s
VS150.90B.GP5	22 F07/F10	150Nm	15V - 30V 50/60Hz (12V - 48V DC)	45W	30s
VS300.90A.GP5	22 F07/F10	300Nm	100V - 240V 50/60Hz (100V - 350V DC)	45W	60s
VS300.90B.GP5	22 F07/F10	300Nm	15V - 30V 50/60Hz (12V - 48V DC)	45W	60s

Rafmagnsrótor - GF3

VR 25-45-75 Nm - VS 100-150-300 Nm

Vörunúmer	Stjama / Lengs á milli róa	Tog	Spenna	Kraftur	tími án álags
VR25.70A.GF3	17 F05/F07	25Nm	100V - 240V 50/60Hz (100V - 350V DC)	45W	7s
VR25.70B.GF3	17 F05/F07	25Nm	15V - 30V 50/60Hz (12V - 48V DC)	45W	7s
VR45.70A.GF3	17 F05/F07	45Nm	100V - 240V 50/60Hz (100V - 350V DC)	45W	15s
VR45.70B.GF3	17 F05/F07	45Nm	15V - 30V 50/60Hz (12V - 48V DC)	45W	15s
VR75.70A.GF3	17 F05/F07	75Nm	100V - 240V 50/60Hz (100V - 350V DC)	45W	20s
VR75.70B.GF3	17 F05/F07	75Nm	15V - 30V 50/60Hz (12V - 48V DC)	45W	20s
VS100.90A.GF3	22 F07/F10	100Nm	100V - 240V 50/60Hz (100V - 350V DC)	45W	15s
VS100.90B.GF3	22 F07/F10	100Nm	15V - 30V 50/60Hz (12V - 48V DC)	45W	15s
VS150.90A.GF3	22 F07/F10	150Nm	100V - 240V 50/60Hz (100V - 350V DC)	45W	30s
VS150.90B.GF3	22 F07/F10	150Nm	15V - 30V 50/60Hz (12V - 48V DC)	45W	30s
VS300.90A.GF3	22 F07/F10	300Nm	100V - 240V 50/60Hz (100V - 350V DC)	45W	60s
VS300.90B.GF3	22 F07/F10	300Nm	15V - 30V 50/60Hz (12V - 48V DC)	45W	60s

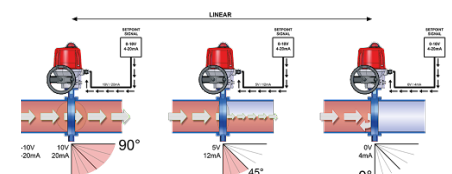

rotork

m&m
international



Segulpóla

Vörunúmer	Gerð	mm	Ø
2200-24V-50/60	24V 50/60 AC lítil		
2150-12V-DC	12V DC lítil 7w		
2250-24V-DC	24V DC lítil		
2700-230V-50/60	230V lítil		



Segulpóla

Vörunúmer	Gerð	mm	Ø
7150-12V-DC	12V DC stór 14w		
7200-24V-AC	24V /50-60		
7250-24V-DC	24V DC Stór		
7701-230/240	230/240V AC		



Segulloki - Ryðfrír

Vörunúmer	Gerð *	Bör
D206-DVYI	3/4" FKM	0,3-16bar
D222-DVYI	1" 25mm m/FKM pakkn	



Segulloki

Vörunúmer	Gerð	*	Bör
B204-DEZ-3/8	EPDM	3/8"	0,3-16bar
B205-DEZ-1/2	EPDM	1/2"	0,3-16 bar
B206-DBY	EPDM	3/4"	0,3-16 bar
B206-DEX-3/4	EPDM	3/4"	120/260C°
B222-DEY-1	EPDM	1"	



Sætisloki

Vörunúmer	Gerð	mm	Ø
BLG205DBW00	1/2" NC O 32		
BPG205STW00	1/2 NC		
BPG206STX00	3/4" NC 0 -1-2og2-1 ryðfrír		
BPG207STY00	1" NC D40 -1-2og2-1		
BPG208LTZ00	1-1/4" NC D40 -1-2og2-1		
BPG209STK00	1 1/2" NC D63 -1-2og2-1		
BPG210LTJ00	2" NC O 63 2 ryðfrír		



Segulloki - Ryðfrír

Vörunúmer	Gerð
B298-DVG-1/8	2,5 mm 1/8 0-3 dc 0-8AC



Segulloki

Vörunúmer	Gerð	Ø	mm
D233DVW	FKM	1/2"	1-50bar -10+130C°
D263-DEG	EPDM	1/4"	2/2 NC 2,5mm
D263-DVG	FKM	1/4"	2/2 NC 2,5mm
D263-DVGM	FKM	1/4"	2/2 NC 2,5mm
D293-DBY	EPDM	1"	0-16bar Kvs140
D301-CVC	FKM	3/2 NC	
D363-CVE	FKM	1/4"	3/2 NC 2,0mm
D399-CVE	FKM	1/4"	3/2 NC - ryðfrír



Sjálfvirk aftöppun

Vörunúmer	Gerð	mm	Ø
888124000	2/2 1/4" 230V/50hz		



Segulloki

Vörunúmer	Gerð	*	Bör
B397-CEC	EPDM	1/8"	3/2 NC
B297-DVE	1/8" 9b DC 18bAC	2/2 NC	



Segulloki

Vörunúmer	Gerð	*	Bör
B920-CVCM	FKM	1/8"	3/2 NC
B921-CVCM	FKM	1/8"	3/2 NC
B919-CVCM	FKM	1/8"	3/2 NC



Segulloki

Vörunúmer	Gerð	*	Bör
D189-DEW	EPDM	1/2"	0-16
D190-DEW	EPDM	3/4"	0-16
D192-DEW	EPDM	1"	0-16
D223-DEKM	EPDM	1-1/4"	0,5-16
D224-DEKM	EPDM	1-1/2"	0,5-16
D225-DEJM	EPDM	2"	0,5-16



Segulloki

Vörunúmer	Gerð	*	Bör
D636-DTT	PTFE	1/2"	fyrir gufu 180°C
D636-DTT1	PTFE	1/2"	Háþrýstiloiki
D886-DVU	vatn/ollía	1/2"	m/m



Segulloki

Vörunúmer	Gerð	mm	Bör
RD236-DEG	NO	1/4" EPDM	0-15bar



Sía - fyrir sjálfvirka aftöppun

Vörunúmer	Gerð
887057000	1/2 út 1/2
887059000	1/2 út 1/4



LOFTHREINSIBÚNAÐUR

BARKAR - DREIFIKISTUR - FITTINGS - LOFTSAMSTÆÐUR



FRÄNKISCHE

profi-air®



sieger design

Loftristar þurfa ekki að vera lýti!

Það eina sem fólk sér af loftskiptikerfinu eru loftristar og því hefur FRÄNKISCHE lagt mikið uppúr hönnun þeirra.

Hinir margverðlaunuðu sieger bræður voru því kallaðir til við þá hönnun og úr varð starline® línan með miklu úrvali af fallegum ristum.

starline®

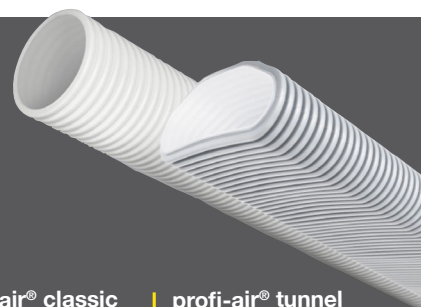
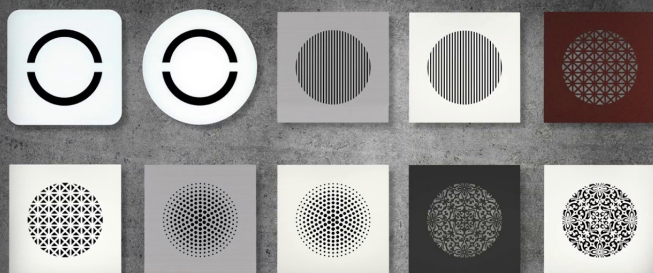

profi-air® classic

- Mikill sveigjanleiki
- Öruggt tengi

profi-air® tunnel

- Mikill höggstyrkur
- Nýjasta tækni í tengjum

profi-air®

LOFTSKIPTIBÚNAÐUR



profi-air® 180 flat

- easySWITCH virkni
- Hægt að setja upp á vegg og loft
- Hægt að stjórna með appi
- Orkunýting eru A eða A+



profi-air® 250/360 flex

- easySWITCH virkni
- Margir möguleikar á tengi
- Hægt að stjórna með appi
- Orkunýting eru A eða A+

profi-air®

**Barki**

Vörunúmer	Gerð	Lengd
78375805	Barki Grátt - 75 mm	50 mtr

**Barki**

Vörunúmer	Gerð	mm	Lengd
78363805	classic - Grár	63	50 m
78390305	classic - Hvítt	90	50 m

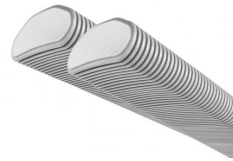
**Barki**

Vörunúmer	Gerð	mm	Lengd
78313202	Flatur barki	132x52	20 m

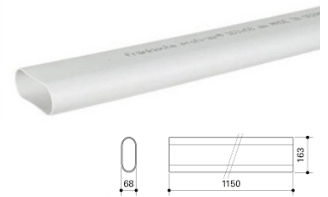
**Rör - sporöskjulaga**

Vörunúmer	Gerð	Lengd
78316401	Ovalkanal - Rör 163x68 - 1,15m	

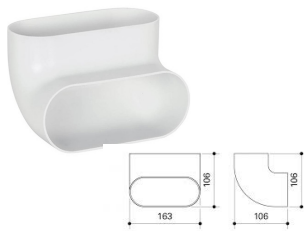
**Hné 90° - lóðrétt**

Vörunúmer	Gerð
78316440	Sporöskjulaga hné 90° - lóðrétt.

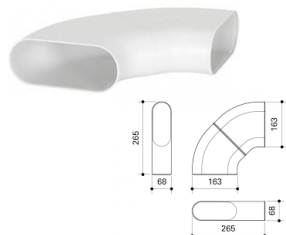
**Hné 90° - lárétt**

Vörunúmer	Gerð
78316441	Sporöskjulaga hné 90° - lárétt.

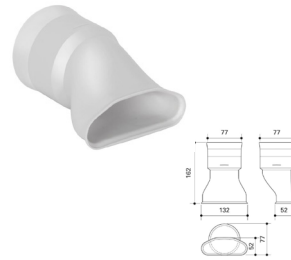
**Breytistykki**

Vörunúmer	Gerð	mm
78313223	Breytistykki 132x52	75 mm

**Millistykki - tvö tengi**

Vörunúmer	Gerð	mm
78316424	tengja 2 sporöskjulaga	160 mm

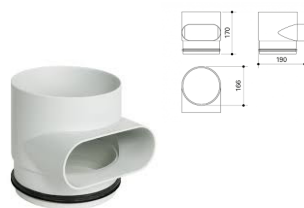
**Té til að tengja sporöskjulaga**

Vörunúmer	Gerð	mm
78316060	Ovalkanal té i ISC	160

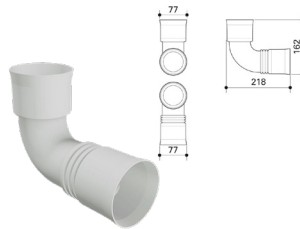
**Hné 90°**

Vörunúmer	Gerð	mm
78375341	Hné 90° - Profi Air	75 mm

**Samtengi - sporöskjulaga**

Vörunúmer	Gerð	mm
78316410	Ovalkanal samtengi	163x68

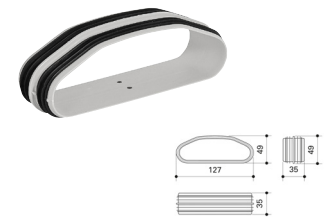
**Samtengi**

Vörunúmer	Gerð	mm
78313210	fyrir flatan barka	132x52

**Festing**

Vörunúmer	Gerð	mm
78313213	fyrir flatan barka	132x52 mm

**Úttak**

Vörunúmer	Gerð	mm
78375381	Úttak 90°	2x75mm Langt
78375382	Úttak 90°	2x75mm Stutt

**Samtengi**

Vörunúmer	Gerð	mm
78375310	classic - Samtengi fyrir	75 mm

**Samtengi**

Vörunúmer	Gerð	Ø
78312111	ISO samtengi	125 mm
78316111	ISO samtengi	160 mm

**Rör m/einangrun**

Vörunúmer	Gerð	Ø	m
78312102	ISO rör m/samtengi	125 mm	1 m
78316102	ISO rör m/samtengi	160 mm	1 m

**Hné 90° m/einangrun**

Vörunúmer	Gerð	Ø
78312141	ISO hné 90° - m/samtengi	125 mm
78316141	ISO hné 90° - m/samtengi	160 mm

**Hné 45° m/einangrun**

Vörunúmer	Gerð	Ø
78312142	ISO hné 45° - m/samtengi	125 mm
78316142	ISO hné 45° - m/samtengi	160 mm

**Minnkun/stækkun**

Vörunúmer	Gerð	Ø
78312120	ISO einangrun	DN160/DN125

profi-air®

**Dreifrikista**

Vörunúmer	Gerð	Litur
78316007	Flöt dreifrikista m/6 stúta	Hvt

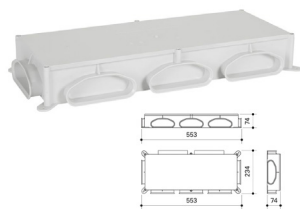
**Dreifrikista - flöt**

Vörunúmer	Gerð
78313005	Flöt dreifrikista tunnel

**profi-air kista**

Vörunúmer	Gerð
78300386	Kista í gólf eða vegg - f/3 stúta

**Framlenging**

Vörunúmer	Gerð
78300086	Framlenging fyrir kistu - 78300368

**Dreifikustusett**

Vörunúmer	Gerð	mm
78316073	Kit á dreifikistu	DN160

**Lok**

Vörunúmer	Gerð
78300321	Lok á dreifikistu

**Viðhaldslok**

Vörunúmer	Gerð
78316071	Viðhaldslok á dreifikistu

**Tengistykki**

Vörunúmer	Gerð	mm
78316072	Tengistykki	160

**Tengistykki**

Vörunúmer	Gerð	mm
78375321	classic - Tengistykki	75 mm

**Tengisett**

Vörunúmer	Gerð	mm
78316820	Tengisett við ISO	160 mm
78318820	Tengisett við ISO	180 mm

**Dós f/úttak**

Vörunúmer	Gerð	Litur
78300081	Dós f/Úttak DN125	gult

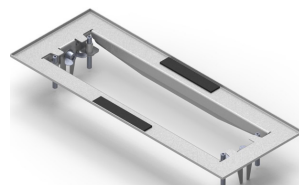
**Rammi - f/golfrist**

Vörunúmer	Gerð	mm
78300699	Rammi f/golfrist	350x130

**Flæðistillir**

Vörunúmer	Gerð	mm
78300007	fyrir kistu í gólf	317x84 mm

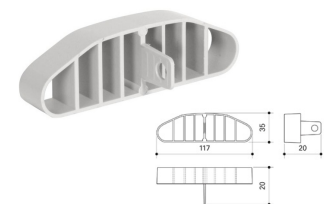
**Flæðistillir**

Vörunúmer	Gerð
78313299	Flæðistillir f/tunnel kistu 63-90mm

**Jafnflæðistillir**

Vörunúmer	Gerð	Litur
78300002	Jafnflæðistillir	20-50 m ³ /h
78300015	Jafnflæðistillir	15 m ³ /h

**Loftflæðistillir**

Vörunúmer	Gerð	mm
78300005	Loftflæðistillir	63-90 mm

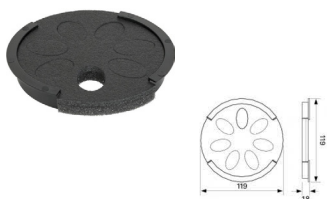
**Loftflæðistillir**

Vörunúmer	Gerð	mm
78312001	Loftflæðistillir DN 125	119

Handvirka loftflæðisstillingu með sjö stillingar með því að opna / loka forgötuð op.
Hentar fyrir innblástursloft og frádráttarloft.
Sjá nánar á

<https://www.youtube.com/watch?v=0pDX5ZyJ5k8>

profi-air®

**Innblástursventill**

Vörunúmer	Gerð	Litur
78312610	Innblástursventill	Hvtur

**Útsogsventill**

Vörunúmer	Gerð	Litur
78312620	Útsogsventill	Hvtur

**Út- / innblástursventill**

Vörunúmer	Gerð	Litur
78312630	Út- / innblástursventill	Hvtur

**Filter**

Vörunúmer	Gerð
78312650	Filter fyrir útsogsventila

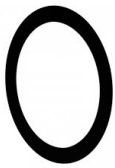
**Þéttihringur**

Vörunúmer	Gerð	mm
78375375	classic - Þéttihringur	75 mm

**Hljóðdeifir**

Vörunúmer	Gerð	mm
78312850	Hljóðdeifir með þéttingum DN 160	
78316850	Hljóðdeifir með þéttingum DN 180	

**Útiloftrist**

Vörunúmer	Gerð	Litur
78316172	Lárétt utanhús.sambyggt	
78316173	Lóðrétt utanhús. sambyggt	

**Útiloftrist - ryðfritt**

Vörunúmer	Gerð	mm
78316174	Utanhúsgnill ryðfritt	160 mm

**Rammi**

Vörunúmer	Gerð	mm	Litur
78312690	Rammi f/compact	122	Svartur

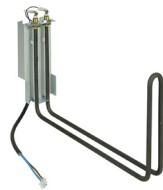
**Lofthitari**

Vörunúmer	Gerð
78301830	Lofthitari fyrir 250 eða 350 flex

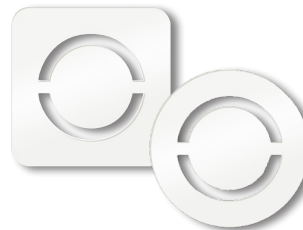
**Loftristar - útsog**

Vörunúmer	Gerð	mm	Litur
78300661	SHAPE STYLE	350x130	hvítt gler
78312661	SHAPE CIRCLE	160x160	hvítt gler
78300660	SHAPE BUSINESS	350x130	hvítt gler
78312660	SHAPE COMPACT	160x160	hvítt gler
78300662	LINE	350x130	hvítt
78312662	LINE COMPACT	160x160	hvítt
78300663	LINE	350x130	ryðfritt stál
78312663	LINE COMPACT	160x160	ryðfritt stál
78300664	PYRAMID	350x130	hvítt
78312664	PYRAMID COMPACT	160x160	hvítt
78300665	PYRAMID	350x130	dökkt brons
78312665	PYRAMID COMPACT	160x160	dökkt brons
78300666	AVANTGARDE	350x130	hvítt
78312666	AVANTGARDE COMPACT	160x160	hvítt
78300667	AVANTGARDE	350x130	ryðfritt stál
78312667	AVANTGARDE COMPACT	160x160	ryðfritt stál
78300668	FLORA	350x130	hvítt
78312668	FLORA COMPACT	160x160	hvítt
78300669	FLORA	350x130	anthracite
78312669	FLORA COMPACT	160x160	anthracite

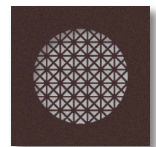
**Loftsamstæða**

Vörunúmer	Gerð	flex
78304725	Loftsamstæða	250 flex
78304736	Loftsamstæða	360 flex
78305718	Loftsamstæða - flöt	180 flex

**Loftsamstæða**

Vörunúmer	Gerð	flex
??????	easySWITCH function	

Sveigjanlegar lofthreingingar til að tryggja að þú hafir alltaf réttan fittings og barka á staðnum!

Meira á næstu bládsíðu



Fallegar og fjölbreyttar ristar

SHAPE BUSINESS



78300660
Stærð: 350x130 mm
Hvitt gler

SHAPE STYLE

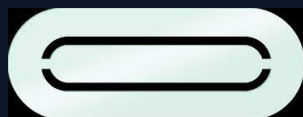

78300661
Stærð: 350x130 mm
Hvitt gler

LINE

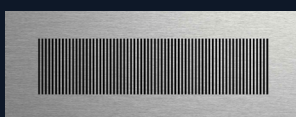

78300663
Stærð: 350x130 mm
Ryðfrit stál

LINE

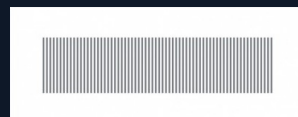

78300662
Stærð: 350x130 mm
Hvitt (RAL 9016)

AVANTGARDE



78300667
Stærð: 350x130 mm
Ryðfrit stál

AVANTGARDE



78300666
Stærð: 350x130 mm
Hvitt (RAL 9016)

FLORA



78300669
Stærð: 350x130 mm
Dökk grár

FLORA



78300668
Stærð: 350x130 mm
Hvitt (RAL 9016)

PYRAMID



78300665
Stærð: 350x130 mm
Dökkt brons

PYRAMID



78300664
Stærð: 350x130 mm
Hvitt (RAL 9016)

sieger design

Það eina sem fólk sér af loftskiptikerfinu eru loftristarnar og því hefur **FRÄNKISCHE** lagt mikið uppúr hönnun þeirra.

Hinir margverðlaunuðu sieger bræður voru því kallaðir til við þá hönnun og úr varð **starline® línan** með miklu úrvali af fallegum ristum.

SHAPE COMPACT



78312660
Stærð: 160x160 mm
Hvitt gler

FLORA COMPACT



78312669
Stærð: 160x160 mm
Dökkt brons

LINE COMPACT

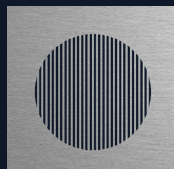

78312663
Stærð: 160x160 mm
Ryðfrit stál

PYRAMID COMPACT

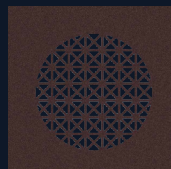

78312665
Stærð: 160x160 mm
Dökkt brons

AVANTGARDE COMPACT

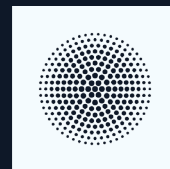

78312667
Stærð: 160x160 mm
Hvitt (RAL 9016)



78312661
Stærð: 160x160 mm
Hvitt gler

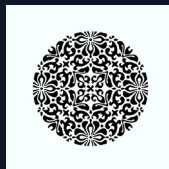

78312668
Stærð: 160x160 mm
Hvitt (RAL 9016)

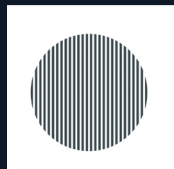

78312662
Stærð: 160x160 mm
Hvitt (RAL 9016)

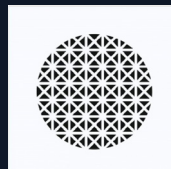

78312664
Stærð: 160x160 mm
Hvitt (RAL 9016)

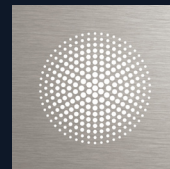

78312666
Stærð: 160x160 mm
Ryðfrit stál



starline®

Sjá nánar um **FRÄNKISCHE**

<https://www.youtube.com/watch?v=FZ9ESVSG2ds>



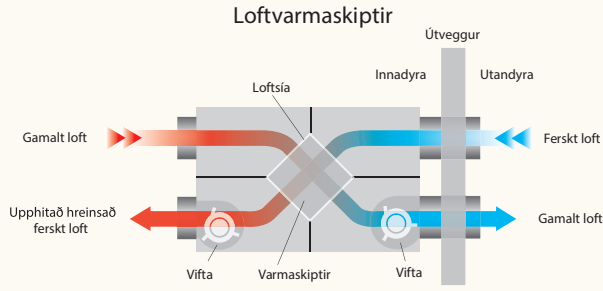

profi-air® loftskiptikerfið frá FRÄNKISCHE hentar vel í nýbyggingar og eldri hús vegna þess hversu fjölbreyttar lausnir kerfið býður uppá.

Orkusparnaður og hreint loft með varmaskiptum

profi-air® kerfið er með innbyggðan varmaskipti og síu þar sem „gama“ loftið er notað til þess að hita upp „nýja“ loftið með allt að 95% varmaskiptum. Loftslán sér síðan um að „nýja“ loftið sé laust við frjókorn, svifryk og önnur óhreinindi sem leynast utan veggja heimilisins.

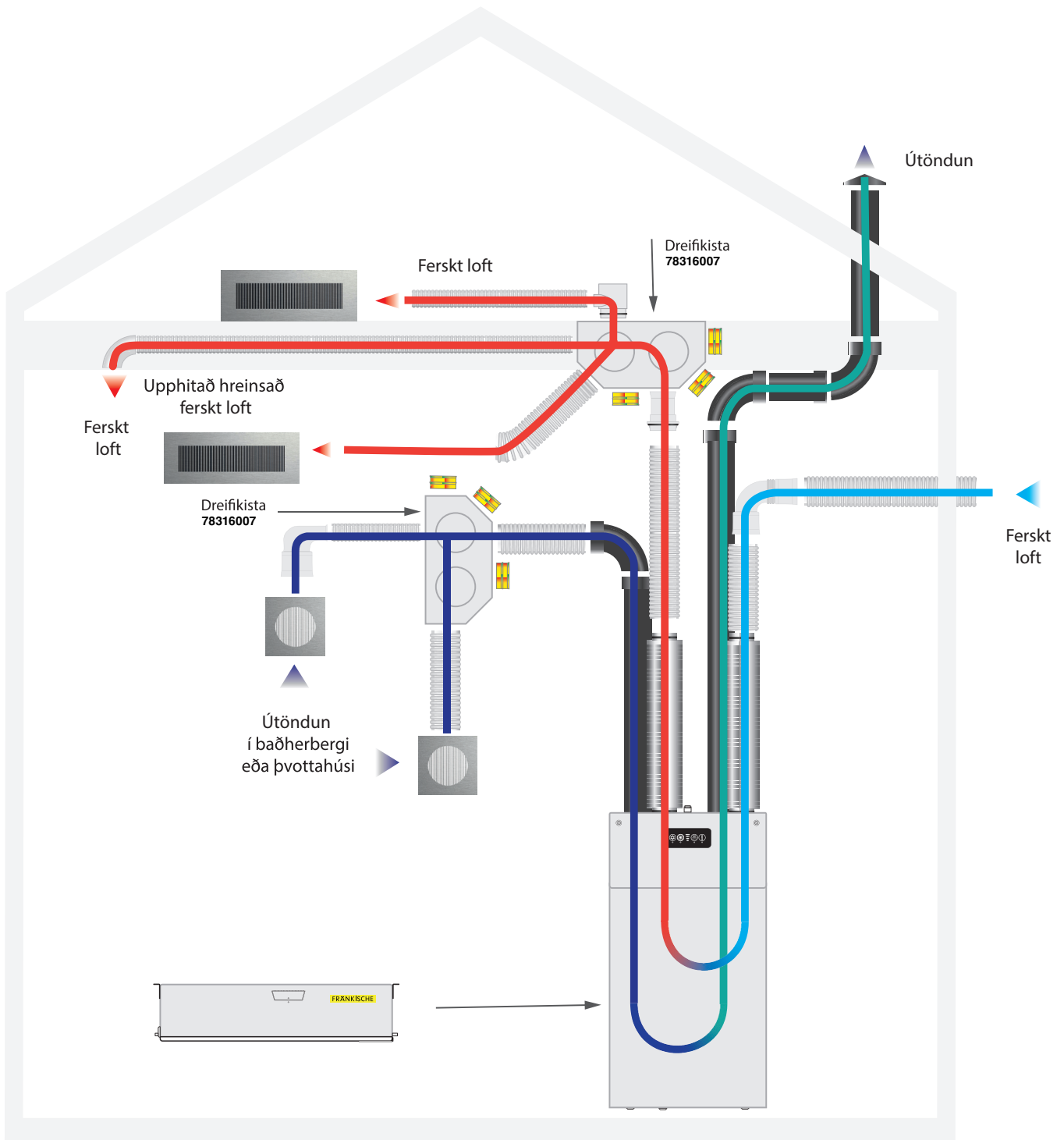

Loftlæðisstillingu með því að opna / loka forgötuð op. Hentar fyrir innblástursloft og frádráttarloft.
Sjá nánar á



<https://www.youtube.com/watch?v=0pDX5ZyJ5k8&t=11s>



78300002 / 78300015
Jafnflæðistillir - 120-50 m³/h / 15 m³/h

78300005
Loftlæðistillir - 63-90 mm

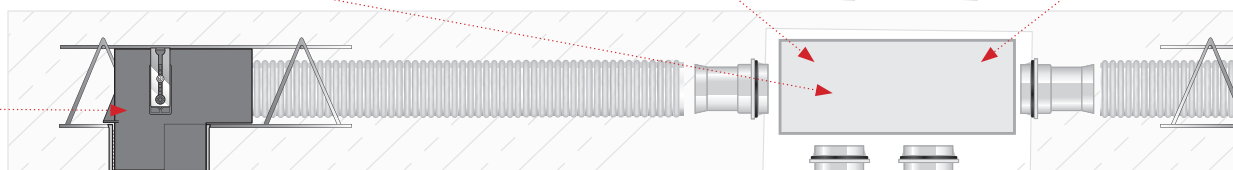
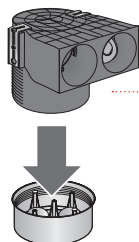

78312086
for 90° air outlet plus DN 125

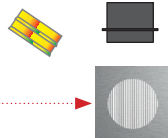

Úrval af
starline
loftristum



Sjá nánar á

<https://www.youtube.com/watch?v=la7F0C-GD3c>

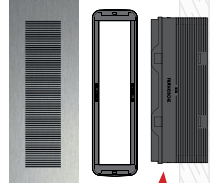
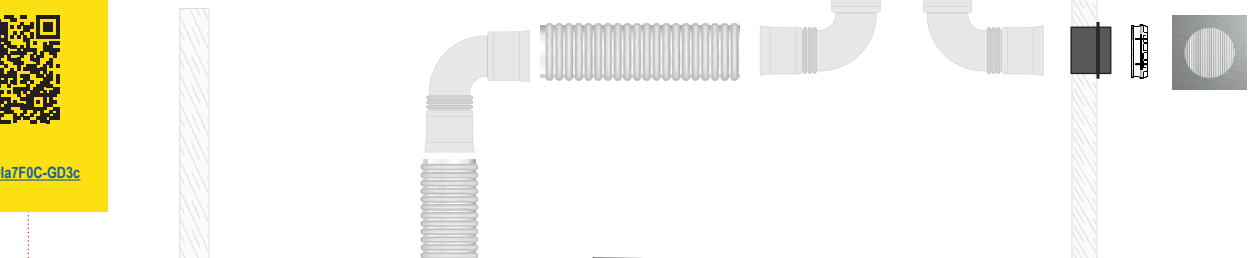

78300695
Rammi-???? -

78300086
Rammi í vegg

78313286
90°, 2-fold, 317 x 84 mm ???

78312001
Loftlæðistillir - DN 125 - 11 mm

Handvirka loftlæðisstillingu með sjö stillingar með því að opna / loka forgötuð op. Hentar fyrir innblástursloft og frádráttarloft.
Sjá nánar á



<https://www.youtube.com/watch?v=0pDX5ZyJ5k8>

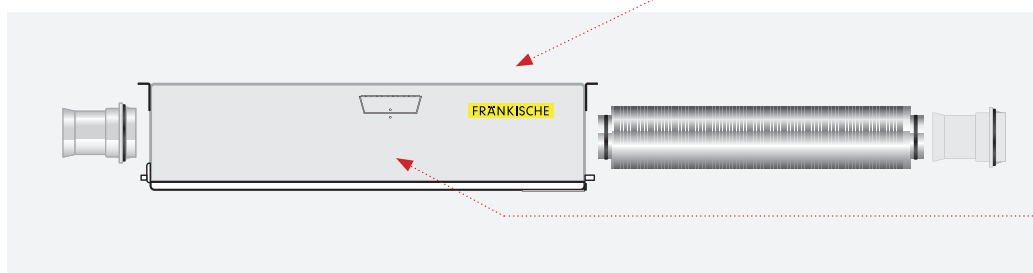

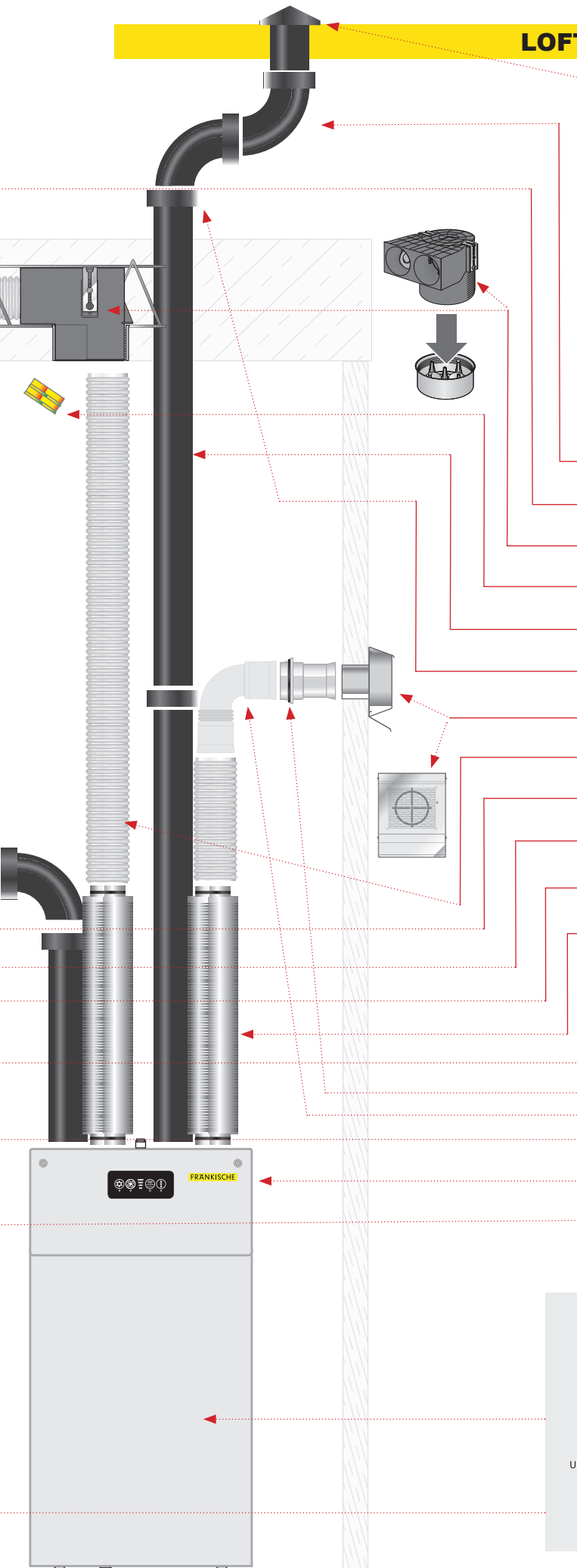

Loftskiptikerfi
TÆKNILEGIR UPPLÝSINGAR

- 78300175
Lofttúða - hattur
- 78316140
Hné 90° - ISO m/samtengi
- 78316006 / 78316011 / 78318016
Dreifikista DN 160 / DN 180 5x stútar / 10x stútar / 15x stútar
- 78375382 / 78375381
Úttak 90° - 2x75mm - Stutt / Langt
- 78300081
Dós f/Úttak DN125 - gult
- 78316101
Rör - ISO rör m/samtengi - 1 m
- 78316110
Samtengi - ISO samtengi - 160 mm
- 78316174
Útanhúsgril ryðfrítt - 160 mm
- 78363805 / 78390305
Barkar - classic - Grár eða hvítur - 50 eða 90 m
- 78363321 / 78375321 / 78390321
Tengistykki - classic - 63 mm / 75 mm / 90 mm
- 78312001 / 78318820
Tengissett við ISO - 160 mm / 180 mm
- 78316007
Flöt dreifkista m/6 súta - Hvít
- 78316072 / 78316850
Hljóðdeifir með þéttingum DN 160 / DN 180
- 78313202
Flatur barki - 132x52 - 20 m
- 78363375 / 78375375 / 78390375
Þéttihringur - classic - 63 mm / 75 mm / 90 mm
- 78363341 / 78375341 / 78390341
Hné 90° - classic bend plus - 63 mm / 75 mm / 90 mm
- 78313226 / 78313227
Hné 90° - 132 x 52 mm - 75 mm / 90 mm
- 78304725 / 78304736
Loftsamstæða - 250 flex / 360 flex
- 78305718
Loftsamstæða - flöt - 180 flex

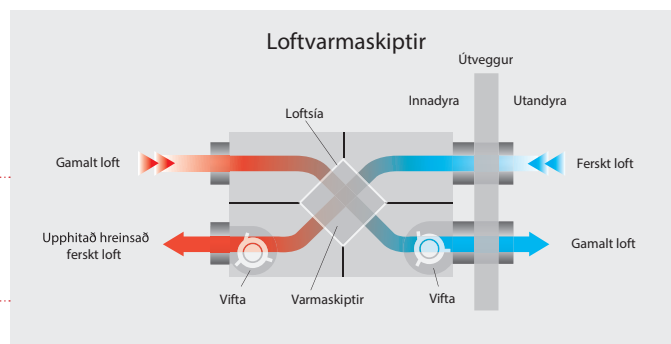

profi-air® - Hugmynd af lofthreinsikerfi

FRÄNKISCHE

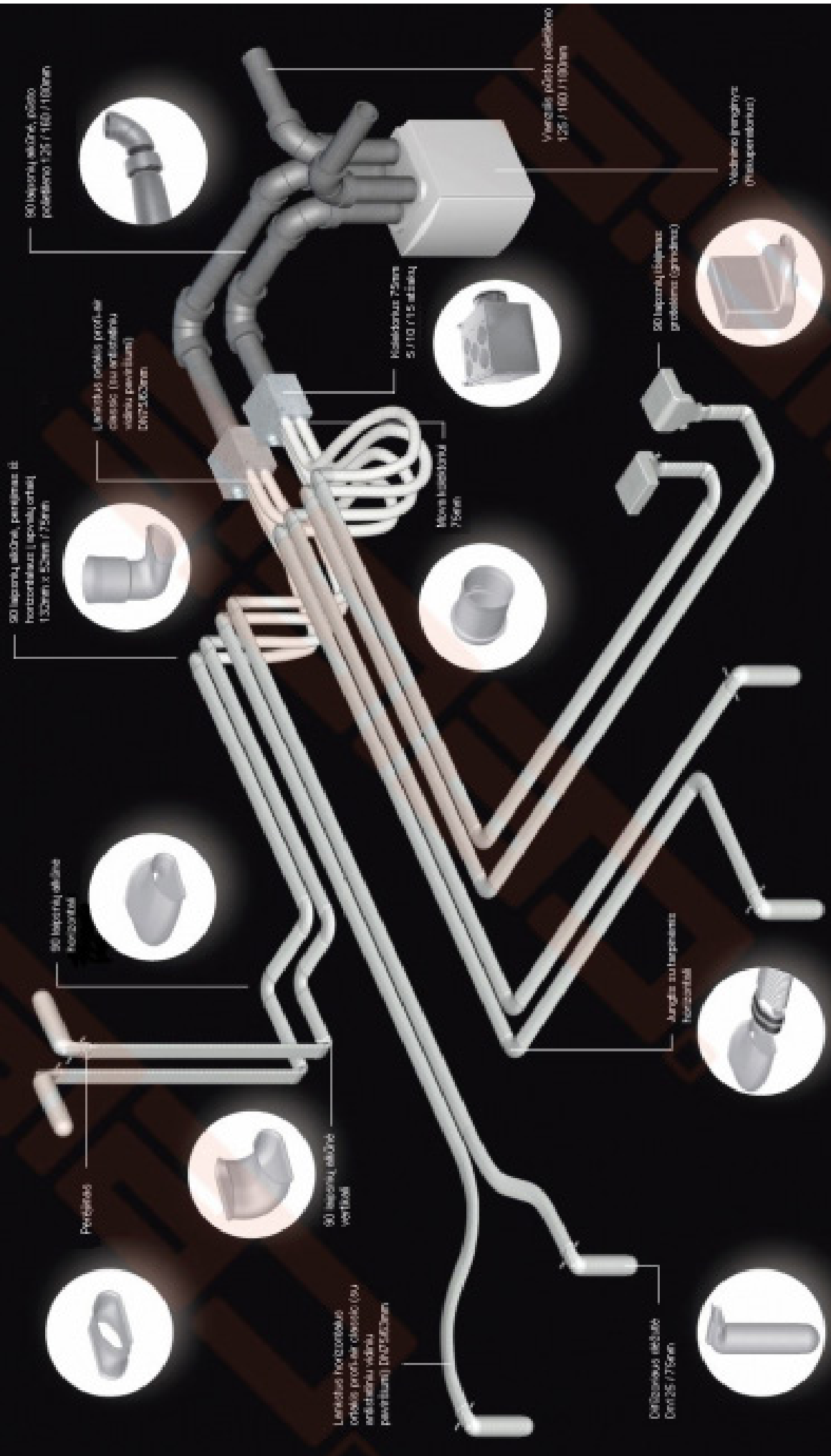

LOFTPRESSUR

BEINDRIFNAR - REIMDRIFNAR - HLJÓÐHLÁTAR





Kraftmiklar, hjóðlátar pressur

Skrúfupressa - NOBEL 7.5-10 / NOBEL 11-10 / NOBEL 15-10

Vörunúmer	Power		Air outflow rate (DV = max. / min.)		Max. pressure		Sound level	Connection	Net weight	Net dimensions	Gross weight	Gross dimension
	kW	HP	m ³ /min.	c.f.m.	bar	p.s.i.	dB(A)	Ø	kg	LxWxH (cm)	kg	LxWxH (cm)
V60CB92PWS445	7,5	10	1,05	37	10	145	62	1/2"	174	88 x 70 x 85	188	94 x 77 x 103
V60CE92PWS445	11	15	1,6	57	10	145	67	3/4"	266	110 x 75 x 100	286	120 x 81 x 121
V60CH92PWS445	15	20	2,1	74	10	145	67	3/4"	282	110 x 75 x 100	302	120 x 81 x 121



Skrúfupressa - NOBEL 7.5-10-270 DF

Vörunúmer	Power		Air outflow rate (DV = max. / min.)		Max. pressure		Sound level	Connection	Net weight	Net dimensions	Gross weight	Gross dimension
	kW	HP	m ³ /min.	c.f.m.	bar	p.s.i.	dB(A)	Ø	kg	LxWxH (cm)	kg	LxWxH (cm)
V91CB92PWS580	7,5	10	1,05	37	10	145	62	1/2"	282	156,5 x 70 x 144	317	172 x 75 x 168



Skrúfupressa - JUNIOR

Vörunúmer	Air receiver	Power		Power supply	Air outflow rate			Max. pressure		Sound level	Connection	Net weight	Net dimensions	Gross weight	Gross dimensions
	l kW	HP	V/P	h/Hz	l/min.	m ³ /min.	c.f.m.	bar	p.s.i.	dB(A)	Ø	kg	L x W x H (mm)	kg	L x W x H (mm)
V91PO92PWS180	270	7.5	10	400/3/50	1050	1.05	37.1	10	145	67	1/2"	215	1200x600x1450	243	1320x850x1720

Beint drifið skrúfupressa, fyrirferðarlítið, áreiðanlegt, hjóðlítill.



LOFTPRESSUR



Skrúfupressa - MERCURY Tronic 5.5-10

Vörunúmer	kW	HP	l/min.	m ³ /h	c.f.m.	bar	p.s.i.	dB(A)	G	kg	lbs	L x W x H (cm)
V51JO92N1N564	5.5	7.5	650	39	22.9	10	145	64	1/2"	126	278	60 x 52 x 78



Skrúfupressa - SIRIO 8-10 / SIRIO 11-10 / SIRIO 16-10

Vörunúmer	kW	HP	l/min.	m ³ /h	c.f.m.	bar	p.s.i.	dB(A)	G	kg	lbs	L x W x H (cm)
V60KH92N1N764	7.5	10	1000	60	35.3	10	145	68	3/4"	212	467	80 x 70 x 98
V60KE92N1N764	11	15	1500	90	53	10	145	69	3/4"	224	494	80 x 70 x 98
V60KU92N1N764	15	20	2050	123	72.4	10	145	68	3/4"	242	534	80 x 70 x 98



Hljóðlátar olíufriar pressur



Stimpilpressa - SILTEK+

Vörunúmer	Olíufri	Lt	Hp / kW	bar	RPM	l/min.	Volt / Hz	kg
B2BE104NUA	OL100	6	1 / 0,75	8	1450	105	230 / 50	17,1



Stimpilpressa - SIL AIR 244/24

Vörunúmer	Olíufri	Lt	Hp / kW	bar	RPM	l/min.	Volt / Hz	kg
B4CA304NUA	OL244	24	1,5 / 1,1	8	1450	130 / 4,6	230 / 50	27,8

KÆLIPURRKARI



Kælipurrkarar - OMI Dolomite Trockner

Vörunúmer	Rennslis hraði / l/min.	Hámarksþrýstingur / bar	Orkunotkun / kW	Mál / cm
DD36	600 l/min	16 Bar	0.12 kW	36 x 30,5 x 40.8 cm
DD54	900 l/min	16 Bar	0.17 kW	43 x 32.5 x 44.5 cm
DD72	1200 l/min	16 Bar	0.17 kW	43 x 32.5 x 44.5 cm
DD144	2400 l/min	16 Bar	0.41 kW	48.6 x 39.5 x 56.5 cm
DD108	3000 l/min	16 Bar	0.47 kW	48.6 x 39.5 x 56.5 cm



Kælipurrkarar - Beko Drypoint RA

Vörunúmer	Rennslis hraði / l/min.	Hámarksþrýstingur / bar	Orkunotkun / kW
4016270	6200 l/min	14 Bar	4,11 kW
4017126	4000 l/min	14 Bar	2,64 kW
4017125	3100 l/min	14 Bar	2,36 kW

LOFTTANKAR

SICC



Tankur

Vörunúmer	Gerð	litrar	litur
1121405051	lóðréttur	900 l	galv.
1121405021	lóðréttur	900 l	blár



Tankur

Vörunúmer	Gerð	litrar	litur
1121005051	lóðréttur	500 l	galv.
1121005021	lóðréttur	500 l	blár



Tankur

Vörunúmer	Gerð	litrar	litur
1120705051	lóðréttur	270 l	galv.
1120705021	lóðréttur	270 l	blár



Tankur

Vörunúmer	Gerð	litrar	litur
1120505021	lóðréttur	200 l	blár

Tæknilegar upplýsingar

Lóðréttur tankur Polir -10° +120°C P 11 bar

Efni: Carbon stál

Húðun: Ytra málning RAL 5015 /
Heitt galvaniseruðu - innra og ytra
Vitroflex á innra yfirborði

Vökví: Þjappað loft / köfnunarefni

Litrar	STÆRÐIR (mm)					TENGINGAR				Þyngd (Kg)
	De	H	H1	H2	H3	A-B	C-D	E	F	
11 bar -10° +120° C										
200	430	1530	135	397	1280	3/4"	2"	3/4"	3/8"	50
270	500	1685	192	442	1422	3/4"	2"	3/4"	3/8"	60
500	600	2077	174	689	1689	1 1/2"	1 1/4"	3/4"	3/8"	130
725	790	1863	200	690	1440	1 1/2"	1 1/4"	3/4"	3/8"	167
900	790	2213	200	800	1800	2"	1 1/4"	3/4"	3/8"	186

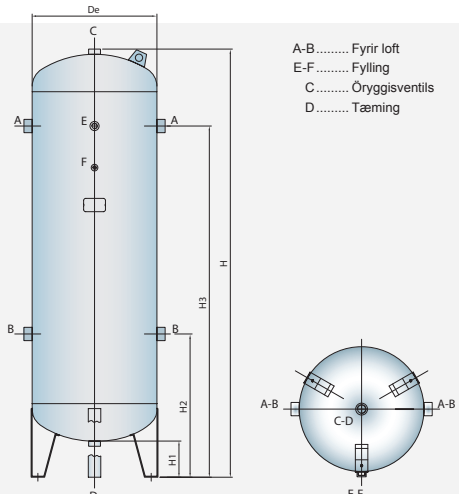

HUGMYND UM UPPSETNINGU FYRIR ÞRÝSTILOFTSKERFI

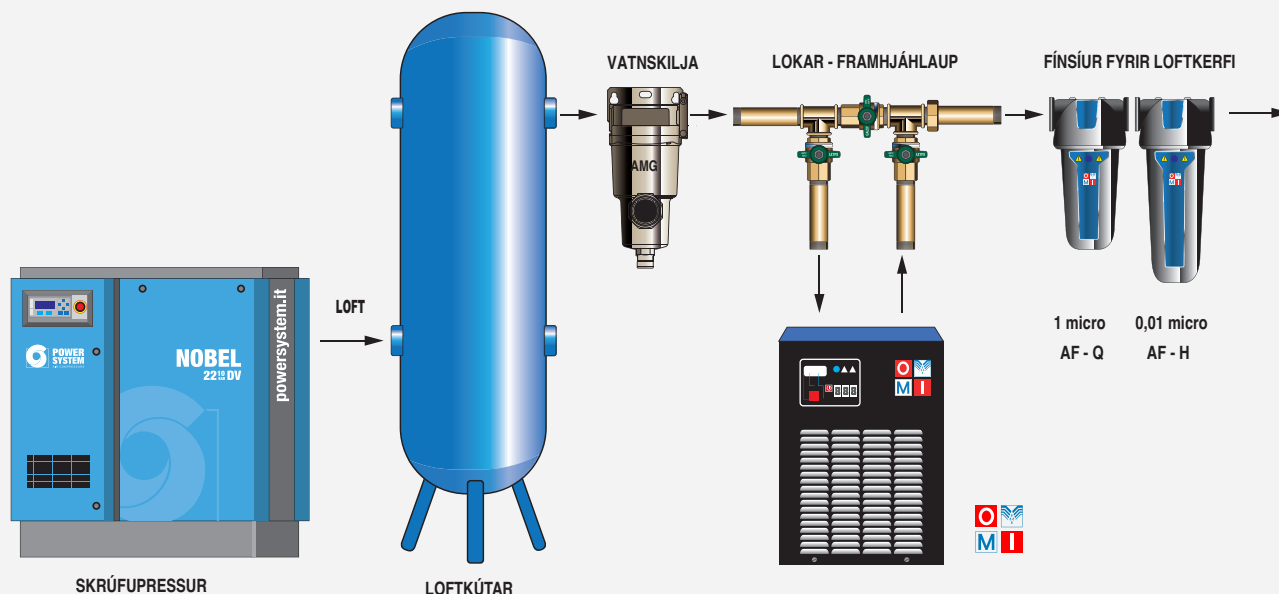



Slöngukefli

Vörunúmer	mm - Ø	Max	Lengd
R523020013	13x20 - 1/2 1/2"	18 bar	20 m



Slöngukefli - ryðfritt

Vörunúmer	mm - Ø	Max	Lengd
R53501210	10x14 - 10 1/2"	20 bar	12 m



Slöngukefli

Vörunúmer	mm - Ø	Max	Lengd
R122010010	10x14 - 10 3/8"	20 bar	10 m



Slöngukefli

Vörunúmer	mm - Ø	Max	Lengd
R222012010	10x14 - 10 3/8"	20 bar	12 m



Gormaslanga - 8/5 mm

Vörunúmer	mm - Ø	lengd	Litur
SB005.008.003	8/5 mm - 1/4"	3 m	Blá
SB005.008.005	8/5 mm - 1/4"	5 m	Blá
SB005.008.008	8/5 mm - 1/4"	8 m	Blá
SB005.008.012	8/5 mm - 1/4"	12 m	Blá



Gormaslanga - 10/6,5 mm

Vörunúmer	mm - Ø	lengd	Litur
SB065.010.005	10/6,5 mm - 1/4"	5 m	Blá
SB065.010.006	10/6,5 mm - 1/4"	6 m	Blá
SB065.010.008	10/6,5 mm - 1/4"	8 m	Blá
SB065.010.012	10/6,5 mm - 1/4"	12 m	Blá



Gormaslanga - 10/8 mm

Vörunúmer	mm - Ø	lengd	Litur
SB008.012.005	10/8 mm - 3/8"	5 m	Blá
SB008.012.008	10/8 mm - 3/8"	8 m	Blá
SB008.012.012	10/8 mm - 3/8"	12 m	Blá



Slöngur - Soft PVC

Vörunúmer	mm - Ø	Lengd	Litur
SNS008.013.050B	8x13 mm	50 m	Blá
SNS010.015.050B	10x15,5 mm	50 m	Blá
SNS012.019.050B	12,7x19 mm	50 m	Blá

SEGULDÆLUR



Seguldrifin miðflótttaflsdæla - efnabolin

Vörunúmer	plastefni	Neðri þétting
MB080-P-TSDN	PP	EPDM

SÍUR

FYRIR ALLAR GERÐIR AF LOFTPRESSUM



Fyrir flestar gerðir af síum og olíuskiljur fyrir loftpressur

 **NOITECH**

SOTRAS



FESTINGAKERFI

EINFALT FESTINGAKERFI



MÜPRO

MÜPRO

Festingakerfi



BRAUTA OG FESTUNGAR - ryðfrítt, galvaneserað, heitgalvaniserað eða ryðfrítt



Brautir 2-6 m.



Brautarkjálkar



Brautarboltar



Söðull
fyrir braut



Veggplatti



Prakket



MPT BRAUTARKERFI - ryðfrítt, galvaneserað, heitgalvaniserað eða ryðfrítt

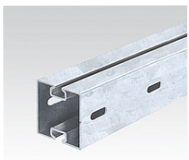

Brautir 2-6 m.



MPT-brautar-
kjálkar



MPT-viklar



MPT-bitafesting,
38/40 og 38/24



Söðull
fyrir braut



Samsetningar



RÖRAFESTINGAR - ryðfrítt eða galvaneserað



Röaraklemmur



Fljótar og einfaldar
röaraklemmur



Festing fyrir tvær
röaraklemmur



Járn
röaraklemmur



Sprinkler
rörafasting

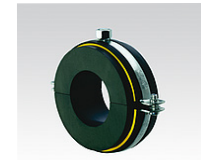

Röaraklemmur
með titringsvörn



FESTI- OG ÞENSLULAUSNIR



Akkerifesting
f/hljóð og þenslu



Akkerifesting
f/hljóð og þenslu



Röaraklemmur
fyrir hljóðeyfa



Swivel hangers,
galvaniserað



Renna
fyrir þenslu



Prakket
fyrir þenslu



ÖFLUGT BURÐARKERFI



Fyrir tvær
röaraklemmur



Festingar
fyrir burðarbita



Röaraklema
til að festa við
burðarstálið



Röaraklema



U-boltar

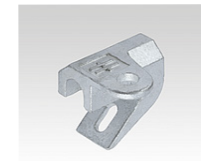

Festingar fyrir
burðarstáli fyrir
þröngu svæði



Galvaniserað og riðfritt



Röraklemmur

OPTIMAL DÄMMGULAST® green

Vörunúmer	Gerð	Stærð	Ø
119842	Galv.	M8, 57 mm	(53-58 mm)
119866	Galv.	M8/M10, ¼"	(13-15 mm)
119882	Galv.	M8/M10, ⅜"	(16-18 mm)
119862	Galv.	M8/M10, ½"	(19-24 mm)
119878	Galv.	M8/M10, ¾"	(25-30 mm)
119850	Galv.	M8/M10, 1"	(32-37 mm)
119858	Galv.	M8/M10, 1½"	(41-44 mm)
119854	Galv.	M8/M10, 1½"	(48-51 mm)
119870	Galv.	M8/M10, 2"	(60-63 mm)
119874	Galv.	M8/M10, 2½"	(74-78 mm)
119794	Galv.	M8/M10, 3"	(88-90 mm)
119770	Galv.	M8/M10, 102 mm	(99-103 mm)
119774	Galv.	M8/M10, 110 mm	(108-112 mm)
119798	Galv.	M8/M10, 4"	(113-117 mm)
119782	Galv.	M8/M10, 125 mm	(125-129 mm)
119802	Galv.	M8/M10, 5"	(137-141 mm)
119790	Galv.	M8/M10, 160 mm	(159-162 mm)
119890	Galv.	M8/M10, 6"	(164-168 mm)



Röraklemmur

OPTIMAL Junior® DÄMMGULAST® green

Vörunúmer	Gerð	Stærð	Ø
141485	Galv.	M8, 12 mm	(12-14 mm)
136101	Galv.	M8, ⅜"	(15-18 mm)
136102	Galv.	M8, ½"	(19-22 mm)
136103	Galv.	M8, ¾"	(23-27 mm)
141486	Galv.	M8, 28 mm	(26-30 mm)
141487	Galv.	M8, 1"	(32-35 mm)
141488	Galv.	M8, 1½"	(42-46 mm)
141490	Galv.	M8, 1½"	(48-51 mm)
141491	Galv.	M8/M10, 55 mm	(53-58 mm)
141492	Galv.	M8/M10, 2"	(59-64 mm)
119532	Galv.	M8/M10, 70 mm	(68-73 mm)
119536	Galv.	M8/M10, 2½"	(74-80 mm)
119540	Galv.	M8/M10, 83 mm	(83-87 mm)
119544	Galv.	M8/M10, 3"	(89-92 mm)
119473	Galv.	M8/M10, 102 mm	(100-104 mm)
119477	Galv.	M8/M10, 110 mm	(108-111 mm)
119481	Galv.	M8/M10, 4"	(112-115 mm)



Röraklemmur

Single bossed clamps with DÄMMGULAST® yellow

Vörunúmer	Gerð	Stærð	Ø
151359	Galv.	M8/M10, ⅜"	(14-20 mm)
151360	Galv.	M8/M10, ½"	(21-26 mm)
151361	Galv.	M8/M10, ¾"	(26-30 mm)
151362	Galv.	M8/M10, 1"	(30-38 mm)
151364	Galv.	M8/M10, 1¼"	(40-47 mm)
151365	Galv.	M8/M10, 1½"	(48-54 mm)
151367	Galv.	M8/M10, 2"	(60-66 mm)
151370	Galv.	M8/M10, 2½"	(73-80 mm)
151372	Galv.	M8/M10, 3"	(87-94 mm)
151373	Galv.	M8/M10, 102 mm	(99-104 mm)
151374	Galv.	M8/M10, 110 mm	(105-112 mm)
151375	Galv.	M8/M10, 4"	(112-118 mm)
151378	Galv.	M8/M10, 5"	(137-142 mm)
151379	Galv.	M8/M10, 144 mm	(142-148 mm)
151380	Galv.	M8/M10, 150 mm	(149-156 mm)
151423	Galv.	M8/M10, 6"	(164-169 mm)
151450	Galv.	M10/M12, 180 mm	(177-183 mm)
151464	Galv.	M12/M16/⅜", 8"	(217-225 mm)



Röraklemmur - ryðfri

Single bossed clamp with DÄMMGULAST® yellow

Vörunúmer	Gerð	Stærð	Ø
157024	V2A	M8/M10, ⅜"	(14-20 mm)
157025	V2A	M8/M10, ½"	(21-26 mm)
157026	V2A	M8/M10, ¾"	(26-30 mm)
157027	V2A	M8/M10, 1"	(30-38 mm)
157028	V2A	M8/M10, 1¼"	(40-47 mm)
157029	V2A	M8/M10, 1½"	(48-54 mm)
157121	V2A	M8/M10, 2"	(60-66 mm)
157123	V2A	M8/M10, 2½"	(73-80 mm)
157125	V2A	M8/M10, 3"	(87-94 mm)
157126	V2A	M8/M10, 102 mm	(99-104 mm)
157127	V2A	M8/M10, 110 mm	(105-112 mm)
157128	V2A	M8/M10, 4"	(112-118 mm)
157129	V2A	M8/M10, 125 mm	(122-128 mm)
157130	V2A	M8/M10, 133 mm	(132-137 mm)
157131	V2A	M8/M10, 5"	(137-142 mm)
157132	V2A	M8/M10, 160 mm	(159-164 mm)
157135	V4A	M8/M10,	(21-26 mm)
157137	V4A	M8/M10, 1"	(31-38 mm)



Röraklemmur m/smellu

DÄMMGULAST® green

Vörunúmer	Gerð	Stærð	Ø
123222	Galv.	M8	10 mm
123226	Galv.	M8	12 mm
123230	Galv.	M8	15 mm
123234	Galv.	M8	16 mm
123261	Galv.	M8, ⅜"	17,2 mm
123238	Galv.	M8	18 mm
123242	Galv.	M8	20 mm
123218	Galv.	M8, ½"	21,3 mm
123246	Galv.	M8	22 mm
123250	Galv.	M8	24 mm
123258	Galv.	M8, ¾"	26,9 mm
123254	Galv.	M8	28 mm
123274	Galv.	M8	33 mm
123206	Galv.	M8, 1"	33,7 mm
123285	Galv.	M8	40 mm
123214	Galv.	M8, 1¼"	42,4 mm
123210	Galv.	M8, 1½"	48,3 mm



Röraklemmur

Heavy-duty version, DÄMMGULAST® yellow

Vörunúmer	Gerð	Stærð	Ø	mm
122266	Galv.	M12	3"	(88-92 mm)
122469	Galv.	M12	6"	(164-170 mm)
122473	Galv.	M12	6"	(164-170 mm)

Ryðfri

122119	V2A	M12	200 mm	(193-203 mm)
122210	V2A	M12	250 mm	(244-254 mm)
121346	V4A	M12	200 mm	(193-203 mm)



Röraklemmur

Vörunúmer	Gerð	Stærð	Ø
151598	Galv.	M8/M10, ⅜"	(14-18 mm)
151599	Galv.	M8/M10, ½"	(19-25 mm)
151600	Galv.	M8/M10, ¾"	(26-30 mm)
151601	Galv.	M8/M10, 1"	(31-37 mm)
151603	Galv.	M8/M10, 1¼"	(43-47 mm)
151604	Galv.	M8/M10, 1½"	(47-52 mm)
151606	Galv.	M8/M10, 2"	(58-63 mm)
151609	Galv.	M8/M10, 2½"	(72-78 mm)
151611	Galv.	M8/M10, 3"	(85-90 mm)
151614	Galv.	M8/M10, 4"	(108-115 mm)
151616	Galv.	M8/M10, 125 mm	(125-130 mm)



Einangrun

RTN+

Vörunúmer	Gerð	Stærð	Ø
149213	PU	15,5-25,5 mm	10 mm
149214	PU	15,5-25,5 mm	12 mm
149215	PU	15,5-25,5 mm	15 mm
149216	PU	15,5-25,5 mm	18 mm
149217	PU	15,5-25,5 mm	22 mm
149219	PU	15,5-25,5 mm	28 mm
149220	PU	15,5-25,5 mm	35 mm
149222	PU	15,5-25,5 mm	42 mm
149223	PU	15,5-25,5 mm	48 mm
149224	PU	15,5-25,5 mm	54 mm
149226	PU	15,5-25,5 mm	60 mm



Sprinkler festing

Vörunúmer	Gerð	Stærð	Ø	mm
147411	Galv.	Type 10, M10	1"	
147412	Galv.	Type 10, M10	1½"	
147413	Galv.	Type 10, M10	1¼"	
147414	Galv.	Type 10, M10	2"	
147415	Galv.	Type 10, M10	2½"	
147416	Galv.	Type 10, M10	3"	
147418	Galv.	Type 10, M10	4"	



U-bolti m/ró DIN3570

Vörunúmer	Gerð	Form	mm
113317	Galv.	form A	22 mm
113320	Galv.	form A	27 mm
113323	Galv.	form A	34 mm
113326	Galv.	form A	43 mm
113329	Galv.	form A	49 mm



Galvaniserað



Twin bracket

Vörunúmer	Gerð	Stærð	mm
107243	Galv.	M8	40
107244	Galv.	M8	55
107245	Galv.	M8	65
107246	Galv.	M8	85
107240	Galv.	M8	105
107241	Galv.	M8	150
107242	Galv.	M8	200



Bolti m/gengjur
báðumegin

Vörunúmer	Gerð	Stærð	mm
121244	Galv.	M8	9
121213	Galv.	M8	15
121221	Galv.	M8	25
121228	Galv.	M8	35
121232	Galv.	M8	45
121236	Galv.	M8	55
121236	Galv.	M8	65
121240	Galv.	M8	65

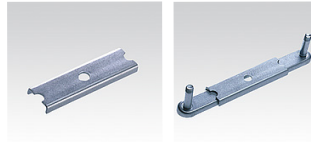

Festingar f/tvöfalda
festingu

Vörunúmer	Gerð	Stærð	mm
107139	Galv.	M8	105 mm



VARIO-tvöfaldur sleði

Vörunúmer	Gerð	Stærð	mm
107248	Galv.	M8	40-80
107249	Galv.	M8	50-95

BRAUTIR OG FESTINGAR



MPC - galvaniserað

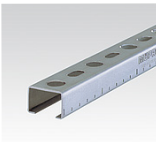

MPC brautir 2-6 m

Vörunúmer	Gerð	Stærð	Lengd
129911	Galv.	27/18	2 m
130003	Galv.	27/18	6 m
118590	Galv.	28/30	2 m
118822	Galv.	28/30	4 m
118994	Galv.	28/30	6 m
139920	Galv.	38/24	2 m
139922	Galv.	38/24	6 m
129917	Galv.	38/40	2 m
129964	Galv.	38/40	4 m
130011	Galv.	38/40	6 m
130015	Galv.	39/52	6 m
130020	Galv.	40/60	6 m



MPC brautarkjálkar

Vörunúmer	Gerð	Stærð	Lengd
156710	Galv.	27/18	200 mm
156711	Galv.	27/18	300 mm
156712	Galv.	27/18	500 mm
156713	Galv.	28/30	240 mm
156714	Galv.	28/30	400 mm
156713	Galv.	28/40	240 mm
156714	Galv.	28/40	400 mm
156716	Galv.	38/40	240 mm
156717	Galv.	38/40	320 mm
156718	Galv.	38/40	400 mm
156721	Galv.	38/40	640 mm
156727	Galv.	38/40	720 mm
156728	Galv.	38/40	800 mm
156723	Galv.	40/60	560 mm



MPC prakket

Vörunr.	Gerð	Stærð	Lengd
114439	Galv.	M8	27/18-28/30
114447	Galv.	M8	38/24, 38/40, 38/48, 38/80
114471	Galv.	M8	39/52, 40/60, 40/80, 40/120
114503	Galv.	M10	27/18-28/30
114450	Galv.	M10	38/24, 38/40, 38/48, 38/80
114474	Galv.	M10	39/52, 40/60, 40/80, 40/120
114477	Galv.	M12	39/52, 40/60, 40/80, 40/120
114459	Galv.	M16	39/52, 40/60, 40/80, 40/120

Heavy-duty

114557	Galv.	M12	39/52, 40/60, 40/80, 40/120
--------	-------	-----	-----------------------------



MPC brautarlok

Vörunúmer	Gerð	Stærð
106000	plastlok	27/18
106002	plastlok	28/30
106004	plastlok	38/24
106006	plastlok	38/40
106007	plastlok	39/52
106008	plastlok	40/60
106009	plastlok	40/80



MPC brautarfestingar

Vörunúmer	Gerð	Stærð
156818	Galv.	7/18-28/30
156816	Galv.	38/24-40/80, 41/21-41/62
156811	Galv.	27/18-28/30
156809	Galv.	38/24-40/60, 41/21-41/62
156817	Galv.	38/24-40/80
156810	Galv.	38/24-40/60



MPC brautarfestingar

Vörunúmer	Gerð	Stærð
156808	Galv.	38/24-40/60



MPC söðull
m/sveiflufestingu

Vörunúmer	Gerð	Stærð
129660	Galv.	38/24-40/120



MPC brautarfestingar

Vörunúmer	Gerð	Stærð
156797	Galv.	27/18-28/30
156799	Galv.	38/40
156796	Galv.	27/18-28/30
156798	Galv.	38/40



MPC - galvaniserað



Brautartengi

Vörunr.	Gerð	Stærð
120136	Galv.	38/40-40/120, 41/21-41/124



Tvöfalt brautartengi

Vörunr.	Gerð	Stærð
134833	Galv.	38/40-40/120, 41/21-41/124



MPC brauta-samsetningur

Vörunr.	Gerð	Stærð
120060	Galv.	tengi 27/18-28/30

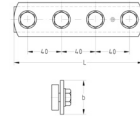

MPC hornstuðningur

Vörunúmer	Gerð	Stærð	Lengd
129790	Galv.	38/24-40/120	440 mm
139228	Galv.	38/24-40/120	900 mm



MPC brautarboltar

Vörunúmer	Gerð	Stærð	Lengd
115152	Galv.	M8 x 30 mm	27/18-28/30
115166	Galv.	M8 x 40 mm	27/18-28/30
115113	Galv.	M8 x 100 mm	27/18-28/30
115104	Galv.	M10 x 35 mm	27/18-28/30



MPC brautarboltar

Vörunúmer	Gerð	Stærð	Lengd
115080	Galv.	M8 x 40 mm	38/24-40/120
115092	Galv.	M8 x 50 mm	38/24-40/120
114999	Galv.	M10 x 55 mm	38/24-40/120
115002	Galv.	M10 x 80 mm	38/24-40/120
114963	Galv.	M10 x 100 mm	38/24-40/120
114966	Galv.	M10 x 120 mm	38/24-40/120



MPC brautarboltar

Vörunúmer	Gerð	Stærð	Lengd
120890	Galv.	M8 x 7 mm	27/18-28/30
120870	Galv.	M8 x 25 mm	27/18-28/30
120882	Galv.	M8 x 45 mm	27/18-28/30
120886	Galv.	M8 x 65 mm	27/18-28/30
120894	Galv.	M8 x 7 mm	38/24-40/120
120874	Galv.	M8 x 30 mm	38/24-40/120
120878	Galv.	M8 x 40 mm	38/24-40/120
120846	Galv.	M10 x 7 mm	38/24-40/120
120834	Galv.	M10 x 25 mm	38/24-40/120
120842	Galv.	M10 x 50 mm	38/24-40/120

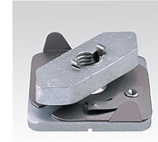

MPC brautarboltar

Vörunúmer	Gerð	Stærð	Lengd
120858	Galv.	M8	27/18-28/30
120822	Galv.	M10	27/18-28/30
120862	Galv.	M8	38/24-40/120
120826	Galv.	M10	38/24-40/120



MPC brautaboltar

Vörunúmer	Gerð	Stærð	Lengd
115298	Galv.	M10 x 30 mm	38/24-40/120
115316	Galv.	M12 x 30 mm	38/24-40/120

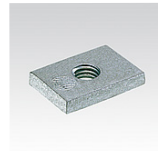

MPC brautarró

Vörunr.	Gerð	Stærð	Lengd
118040	Galv.	M8, 32,8 x 23 x 6	38/24-40/120
117968	Galv.	M10, 32,8 x 23 x 6	38/24-40/120
117986	Galv.	M12, 32,8 x 23 x 6	38/24-40/120



MPC brautarró

Vörunr.	Gerð	Stærð	Lengd
117944	Galv.	M10	38/24-40/120



MPC bitafesting

Vörunúmer	Gerð	Stærð	Lengd
130281	Galv.	M6	27/18-28/30
130283	Galv.	M8	38/24, 38/40



MPC vinkill

Vörunúmer	Gerð	Lýsing	Stærð
118753	Galv.	vinkill 45°	27/18-28/30
118797	Galv.	vinkill 90°	27/18-28/30
118906	Galv.	vinkill 90°	38/24-40/120



MPC horn vinkill

Vörunúmer	Gerð	Lýsing	Stærð
118906	Galv.	tvöfaldur vinkill 90°	38/24-40/120



MPC vinkill 45°

Vörunúmer	Gerð	Lýsing	Stærð
118769	Galv.	vinkill 45°	38/24-40/120



Brautarþrihyrningur 90°

Vörunr.	mm	Lengd
113643	200x200x6	38/24-40/120, 41/21-41/124

MPC - galvaniserað



Skrúfa f/bolta m/gengjum

Vörunúmer	Gerð	Stærð mm
129714	Galv. skrúfbolti	M8 x 50
129717	Galv. skrúfbolti	M8 x 60
129725	Galv. skrúfbolti	M8 x 80
129694	Galv. skrúfbolti	M8 x 100
129702	Galv. skrúfbolti	M8 x 120
129678	Galv. skrúfbolti	M10 x 60
129680	Galv. skrúfbolti	M10 x 60
129666	Galv. skrúfbolti	M10 x 80
129668	Galv. skrúfbolti	M10 x 100
129670	Galv. skrúfbolti	M10 x 120



Franskar skrúfur - DIN 571

Vörunúmer	Gerð	Stærð	mm
105331	Galv.	H10 - tréskrúfa	50
105333	Galv.	H10 - tréskrúfa	60
105338	Galv.	H10 - tréskrúfa	80
105321	Galv.	H10 - tréskrúfa	100



Veggplattar

Vörunúmer	Gerð	Stærð
112397	Galv. - stærð 1	M8/M10

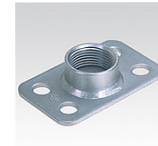

Veggplattar

Vörunúmer	Gerð	Stærð
112825	Galv. - stærð 3	1/2"
112829	Galv. - stærð 3	3/4"
112817	Galv. - stærð 3	1"



Hosuklemma DIN 3017

Vörunúmer	Gerð	Stærð	mm
153412	Galv.	9 mm	8-12
153413	Galv.	9 mm	10-16
153416	Galv.	9 mm	12-22
153418	Galv.	9 mm	16-27
153421	Galv.	9 mm	25-40
153424	Galv.	9 mm	40-60



Bitaklemma

Vörunúmer	Gerð	Stærð	bil mm
130260	Galv.	M8	3-18
130252	Galv.	M10	0-20



Vingusveiflufesting - Klemma

Vörunúmer	Gerð	Stærð
130262	Galv.	M8
130261	Galv.	M10



Keðja

Vörunúmer	Gerð	Stærð	Rúlla
112096	Galv. DIN763,	4 x 32 mm,	30 m



Gataplata

Vörunr.	Gerð	Stærð	Lengd
129076	Stabofix Galv.	50x3 mm	2 m

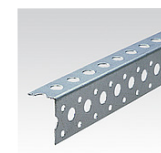

Gatavinkill

Vörunúmer	Gerð	Stærð
127858	Galv.	1 m



MPC krosstengingar

Vörunúmer	Gerð	Lýsing	Lengd
118243	Galv.	samsetning	28/30
118246	Galv.	samsetning	38/40
144838	Galv.	samsetning	38/48
145069	Galv.	samsetning	39/52
118316	Galv.	samsetning	40/60
118276	Galv.	samsetning	38/80, 40/80
118284	Galv.	samsetning	40/120



MPC lamir

Vörunúmer	Gerð	Lýsing	Lengd
139746	Galv.	lamir	38/40



Upphengja í trapísu

Vörunúmer	Gerð	Stærð
130202	Galv. - m/ró	M8
130201	Galv. m/ró	M10



Gataborði

Vörunúmer	Gerð	Rúlla
114807	Galv. - 12 mm	10 m
114786	Galv. - 19 mm m/plast	10 m



Ryðfritt - V2A - V4A



MPC brautir 2-6 m

Vörunúmer	Gerð	Stærð	Lengd
129907	Ryðfritt - V2A	27/18	2 m
118582	Ryðfritt - V2A	28/30	2 m
129914	Ryðfritt - V2A	38/40	2 m



MPC prakket

Vörunr.	Gerð	Stærð	Lengd
114539	V2A	M8	27/18-28/30
114506	V2A	M10	27/18-28/30
114542	V2A	M8	38/40
114512	V2A	M10	38/40



MPC brautarsleði

Vörunúmer	Gerð	Stærð
156822	V2A - þvers	27/18-28/30
156824	V2A - þvers	38/40-40/60
156821	V2A - lang	27/18-28/30
156823	V2A - lang	38/24-40/60, 41/21-41/62
156826	V4A - þvers	38/40-40/60, 41/21-41/62
156825	V4A - lang	38/40-40/60, 41/21-41/62



Röraklemmur - ryðfri
Single bossed clamp with DÄMMGULAST® yellow

Vörunúmer	Gerð	Stærð	Ø
157024	V2A	M8/M10, ¾"	(14-20 mm)
157025	V2A	M8/M10, ½"	(21-26 mm)
157026	V2A	M8/M10, ¾"	(26-30 mm)
157027	V2A	M8/M10, 1"	(30-38 mm)
157028	V2A	M8/M10, 1¼"	(40-47 mm)
157029	V2A	M8/M10, 1½"	(48-54 mm)
157121	V2A	M8/M10, 2"	(60-66 mm)
157123	V2A	M8/M10, 2½"	(73-80 mm)
157125	V2A	M8/M10, 3"	(87-94 mm)
157126	V2A	M8/M10, 102 mm	(99-104 mm)
157127	V2A	M8/M10, 110 mm	(105-112 mm)
157128	V2A	M8/M10, 4"	(112-118 mm)
157129	V2A	M8/M10, 125 mm	(122-128 mm)
157130	V2A	M8/M10, 133 mm	(132-137 mm)
157131	V2A	M8/M10, 5"	(137-142 mm)
157132	V2A	M8/M10, 160 mm	(159-164 mm)



MPC brautarkjálkar

Vörunúmer	Gerð	Stærð	Lengd
156710	Galv.	27/18	200 mm
156711	Galv.	27/18	300 mm
156712	Galv.	27/18	500 mm
156713	Galv.	28/30	240 mm
156714	Galv.	28/30	400 mm
156713	Galv.	28/40	240 mm
156714	Galv.	28/40	400 mm
156716	Galv.	38/40	240 mm
156717	Galv.	38/40	320 mm
156718	Galv.	38/40	400 mm
156721	Galv.	38/40	640 mm
156727	Galv.	38/40	720 mm
156728	Galv.	38/40	800 mm
156723	Galv.	40/60	560 mm



MPC brautarfestingar

Vörunúmer	Gerð	Stærð	Lengd
115134	V2A	M8 x 25	27/18-28/30
115143	V2A	M8 x 30	27/18-28/30
115157	V2A	M8 x 40	27/18-28/30
115169	V2A	M8 x 50	27/18-28/30
115184	V2A	M8 x 80	27/18-28/30
115059	V4A	M8 x 25	38/40-40/60
115077	V4A	M8 x 35	38/40-40/60
115095	V4A	M8 x 50	38/40-40/60
114993	V4A	M10 x 35	38/40-40/60



MPC krossfesting

Vörunúmer	Gerð	Lengd
156803	V2A	38/40



Röraklemmur
Heavy-duty version, DÄMMGULAST® yellow

Vörunúmer	Gerð	Stærð	Ø mm
122119	V2A	M12	200 mm (193-203 mm)
122210	V2A	M12	250 mm (244-254 mm)
121346	V4A	M12	200 mm (193-203 mm)



MPC brautatengi

Vörunúmer	Gerð	Stærð	Lengd
120052	V2A		27/18-28/30
120064	V2A		38/40-40/60



Ryðfri bitafesting

Vörunúmer	Gerð	Stærð	Lengd
130282	V2A	M6	27/18-28/30
130270	V2A	M10	38/40-40/60
130280	V4A	M6	27/18-28/30
130271	V4A	M10	38/40-40/60



MPC krossstengingar

Vörunúmer	Gerð	Lýsing	Lengd
118228	V2A	krossstengingar	28/30
118249	V2A	krossstengingar	38/40



MPC festing f/halla

Vörunúmer	Gerð	Lengd
129659	V2A- f/halla	38/40-40/60



Brautasleði

Vörunúmer	Gerð	Stærð
148349	V2A	1,75kN M8/M10
148345	V4A	1,75kN M8/M10



Veggplattar

Vörunúmer	Gerð	Stærð
112399	V2A - stærð 1	M12
112379	V4A - stærð 1	M8
112373	V4A - stærð 1	M10



MPC brautarboltar

Vörunúmer	Gerð	Stærð	Lengd
115307	V2A	M10 x 30	38/40-40/60



MPC brautarrær

Vörunúmer	Gerð	Stærð	Lengd
120866	Ryðfritt - V2A	M8	38/40-40/60
120830	Ryðfritt - V2A	M10	38/40-40/60

Ryðfrítt - V2A - V4A

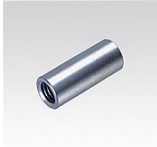

Samsetningarhulsa

Vörunúmer	Gerð	Stærð mm
113262	V2A - tengi	M8 x 30
113277	V2A - tengi	M8 x 40
113169	V2A - tengi	M10 x 30
113178	V2A - tengi	M10 x 40



Ró - DIN 934

Vörunúmer	Gerð	Stærð
105488	V4A - ró	M8
105425	V4A - ró	M10



Snittteinar

Vörunúmer	Gerð	Stærð	mm
113624	V4A - Snittaðir teinar	M8	1.000
113458	V4A - Snittaðir teinar	M10	1.000



Snittpinnar

Vörunúmer	Gerð	Stærð mm
114160	V2A - Snittpinni	M8 x 25
114175	V2A - Snittpinni	M8 x 30
114202	V2A - Snittpinni	M8 x 40
114217	V2A - Snittpinni	M8 x 50
114235	V2A - Snittpinni	M8 x 60
114247	V2A - Snittpinni	M8 x 70
114256	V2A - Snittpinni	M8 x 80
114265	V2A - Snittpinni	M8 x 90
114105	V2A - Snittpinni	M8 x 100
114122	V2A - Snittpinni	M8 x 120
114131	V2A - Snittpinni	M8 x 140



Skrúfa f/bolta m/gengjum

Vörunúmer	Gerð	Stærð mm
129713	V2A skrufbolti	M8 x 50
129716	V2A skrufbolti	M8 x 60
129723	V2A skrufbolti	M8 x 80
129697	V2A skrufbolti	M8 x 100
129701	V2A skrufbolti	M8 x 120
129677	V2A skrufbolti	M10 x 60
129679	V2A skrufbolti	M10 x 80
129665	V2A skrufbolti	M10 x 100

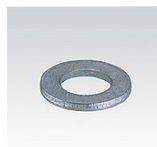

MPC Skinna

Vörunúmer	Gerð	Stærð
127272	V4A	DIN 125 M8
127283	V4A	DIN 125 M10

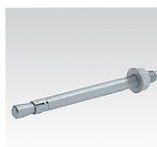

Múrbolti

Vörunúmer	Gerð	Stærð mm
129518	V4A reknagli	ST 8-45
129494	V4A reknagli	ST 10-20
129492	V4A reknagli	ST 10-50



Múrhulsa

Vörunúmer	Gerð	Stærð
129087	V4A - Stál	M8 x 30
129082	V4A - Stál	M10 x 40
129083	V4A - Stál	M12 x 50



BZ Heavy-duty reknagli

Vörunúmer	Gerð	Stærð mm
116718	V4A BZ reknagli	M12 x 15



MPC bitaklemma

Vörunúmer	Gerð	Stærð	bil mm
130235	V2A	M10	0-16
130249	V4A	M10	0-16



Veggplattar

Vörunúmer	Gerð	Stærð
112431	V2A - stærð 2	½"
112441	V2A - stærð 3	¾"
112429	V2A - stærð 4	1"
112411	V4A - stærð 2	½"
112413	V4A - stærð 2	¾"
112409	V4A - stærð 2	1"

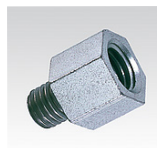

Minnkunn / stækkun

Vörunúmer	Gerð	Stærð mm
113500	V2A - tengi	M8 / M10
113465	V2A - tengi	M10 / M8
113453	V2A - tengi	M10 / M12
113471	V2A - tengi	M12 / M10



Gataborði

Vörunúmer	Gerð	Rúlla
114792	V2A - 17 mm	10 m
114795	V2A - 17 mm	50 m

113756	V2A - Snittpinnar	M10 x 25
113771	V2A - Snittpinnar	M10 x 30
114163	V4A - Snittpinni	M8 x 25
114181	V4A - Snittpinni	M8 x 30
114205	V4A - Snittpinni	M8 x 40
114220	V4A - Snittpinni	M8 x 50
114238	V4A - Snittpinni	M8 x 60
114250	V4A - Snittpinni	M8 x 70
114259	V4A - Snittpinni	M8 x 80
114268	V4A - Snittpinni	M8 x 90
114112	V4A - Snittpinni	M8 x 100
114125	V4A - Snittpinni	M8 x 120
114134	V4A - Snittpinni	M8 x 140
113759	V4A - Snittpinni	M10 x 25
113774	V4A - Snittpinni	M10 x 30
113810	V4A - Snittpinni	M10 x 50
113834	V4A - Snittpinni	M10 x 60
113855	V4A - Snittpinni	M10 x 80
113989	V2A - Snittpinni	M12 x 60
113998	V2A - Snittpinni	M12 x 80
113876	V2A - Snittpinni	M12 x 100



MPC - galvaniserað



Festing - Hljóðdeyfir

Vörunúmer	Gerð	Hljóðstyrkur	Stærð
120292	Galv.	dB 27	M10
120296	Galv.	dB 40	M12



Botton - Hljóðdeyfir

Vörunúmer	Gerð	Stærð
120442	Galv. - Hljóðdeyfir	M10

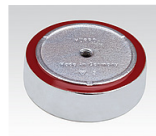

Foot - Hljóðdeyfir

Vörunúmer	Gerð	Stærð
120430	Galv. - Hljóðdeyfir	M12

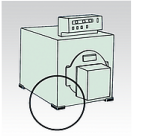

Titringsvörn fyrir horn- og hlíðarfestingu

Vörunúmer	Gerð	Stærð mm
107118	Hornfesting	90 x 90
107114	Hlíðarfesting	90 x 90



Titringsvörn

Vörunúmer	Gerð	Stærð
117722	Titringsvörn	M8

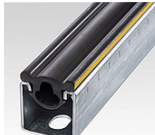

DÄMMGULAST® gúmmí f/braut

Vörunr.	Stærð	rúlla
151189	41/21-41/124	20 m

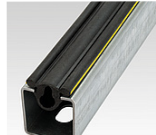

DÄMMGULAST® gúmmí f/braut

Vörunr.	Stærð	rúlla
107690	38/24-40/120	50 m



Upphengt titringsvörn

Vörunr.	Gerð	Stærð
117736	Galv. - titringsvörn	M8
117733	Galv. - titringsvörn	M10



MPC veggkjálki án hljóðeinangrunar

Vörunúmer	Gerð	Stærð	Lengd
113538	Galv.	38/40	460 mm
113544	Galv.	38/40	560 mm
113547	Galv.	38/40	640 mm
113550	Galv.	38/40	800 mm
113535	Galv.	38/40	1.040 mm



Plastmerkimiði - hvítur

Vörunúmer	Gerð	mm
119694	Plast - ómerktur	100 x 50 mm



Merkiplata

Vörunúmer	Gerð	Stærð	mm
154643	Galv.	100 x 50 mm	M8



Bracket f/merkiplötu

Vörunúmer	Gerð
130380	Galv. / Plast f/bolta



Stramp f/merkiplötu

Vörunúmer	Gerð	rúlla
124940	Galv.	15 m



Einfalt festingakerfi



Brautir og festingar



MPT burðarkerfi



Einangrun



Merkiplötur



Festingar



Rörafestingar



Festi- og penslustaðir



Sterkari burðarkerfi



Aukahlutiri



Lofttræstikerfi



Eldvarnir



Vibringsvarnir



Heit galvaniserað



Ofna-festingar



Ryðfriar brautir og festingar



Þéttingar og varnir



Röratengi



Verkfæri

MÜPRO

PURRBORUN



Kjarnaborvél

Vörunúmer	Gerð
CAROMAX1800	Borvél f/purrborun

TÆKNILEGIR UPPLÝSINGAR

Afl og spenna: 1800 W - 230 V
Hámark bora: 202 mm
Togkraftur: 19 Nm
Slagkraftur: 33000 högg/mín at 0.1 Joule
Hraði: 1650 Rpm
Festingar: M18
Vélknúin kúpling: já
Rafræn kúpling: já
Fylgir með: Coring borvél og fylgihlutir í plastkassa
Þyngd: 5.2 kg.



Flisaborun

Vörunúmer	Gerð
CAROMAX800	Borvél f/flisar

TÆKNILEGIR UPPLÝSINGAR

Afl og spenna: 800 W - 230 V
Hámark bora: 68 mm
 Hnappur til að stjórna flæði vatns
Hámarksdýpt: 60 mm
Fylgir með: mál, miðjukerfi, 3 millistykki og 3 kjarna bitar 6/8/10
Þyngd: 3.4 kg.
Fylgir: hliðar handgrip með vatns hnapp



Ryksuga

Vörunúmer	Gerð
ASPIRAMAX25M	1600W

TÆKNILEGIR UPPLÝSINGAR

Afl og spenna: 1400 W - 230 V
 Sjálfvirk síuhreinsun
Rennsli: 25 L
Parki: 4.5 m
Ragmagnssnúra 8 m
Mál: 57x36x37 cm
Þyngd: 12 Kg



Kjarnaborar - VACUUM 300 CORE BIT

Vörunúmer	Gerð	mm	*
FL07068A14	VACUUM 300 CORE BIT	68x70	1*1/4
FL07082A14	VACUUM 300 CORE BIT	82x70	1*1/4
FL25032A14	VACUUM 300 CORE BIT	32x300	1*1/4
FL25035A14	VACUUM 300 CORE BIT	37x300	1*1/4
FL25037A14	VACUUM 300 CORE BIT	37x300	1*1/4
FL25042A14	VACUUM 300 CORE BIT	42x300	1*1/4
FL25052A14	VACUUM 300 CORE BIT	52x300	1*1/4
FL25057A14	VACUUM 300 CORE BIT	57x300	1*1/4
FL25062A14	VACUUM 300 CORE BIT	62x300	1*1/4
FL25068A14	VACUUM 300 CORE BIT	68x300	1*1/4
FL25072A14	VACUUM 300 CORE BIT	72x300	1*1/4
FL25082A14	VACUUM 300 CORE BIT	82x300	1*1/4
FL25092A14	VACUUM 300 CORE BIT	92x300	1*1/4
FL25102A14	VACUUM 300 CORE BIT	102x300	1*1/4
FL25112A14	VACUUM 300 CORE BIT	112x300	1*1/4
FL25122A14	VACUUM 300 CORE BIT	122x300	1*1/4
FL25127A14	VACUUM 300 CORE BIT	127x300	1*1/4
FL25132A14	VACUUM 300 CORE BIT	132x300	1*1/4
FL25142A14	VACUUM 300 CORE BIT	142x300	1*1/4
FL25152A14	VACUUM 300 CORE BIT	152x300	1*1/4
FL25162A14	VACUUM 300 CORE BIT	162x300	1*1/4
FL25205A14	VACUUM 300 CORE BIT	205x300	1*1/4

LÝSING

Borarnir hentar fyrir þá sem vilja lítið sem ekkert ryk. Vacuum 300 Core Bit lögun einnig sömu demantur hluti og 150 mm langar kjarna bita og er því fær um að þurrka bora (eða blautur bora) efni eins og steinsteypu, múrsteinn, flisar og steypu. Vinnuskurður lengd er 300 mm.



Bor

Vörunúmer	Gerð	mm	*
FOG18A12	Bor	18	1/2
FOG20A12	Bor	20	1/2



Miðja

Vörunúmer	Gerð
PICE1030	Miðja fyrir bor



Framlenging

Vörunúmer	mm - Ø	lengd	Litur
PR1414250		Framlenging f/hulsbor 250mm	



Ryksuguhaus

Vörunúmer	Gerð	*
TROT18F	Haus fyrir ryksuga á Caromax 1800	11/4"



Bormiðja

Vörunúmer	Gerð	mm
PIASTRA032	Miðja fyrir bor	32
PIASTRA052	Miðja fyrir bor	52
PIASTRA057	Miðja fyrir bor	57
PIASTRA062	Miðja fyrir bor	62
PIASTRA068	Miðja fyrir bor	68
PIASTRA082	Miðja fyrir bor	82
PIASTRA102	Miðja fyrir bor	102
PIASTRA112	Miðja fyrir bor	112
PIASTRA122	Miðja fyrir bor	122
PIASTRA127	Miðja fyrir bor	127
PIASTRA142	Miðja fyrir bor	142
PIASTRA162	Miðja fyrir bor	162
PIASTRA205	Miðja fyrir bor	205



Stýrisett

Vörunúmer	mm - Ø	lengd	Litur
VALIGASP3		Stýrisett f/Hulsbora 112-200mm	



Professional Plumbing Tools



Kjarnaborvél - Borvél

Vörunúmer	Gerð	Afl
900800	MGF borvél fyrir þurrborun	1800W



Kjarnaborar - Þurrbor

Vörunúmer	Gerð	mm	*
280810.032	MGF DIAMONND	32x320	1*1/4
280810.037	MGF DIAMONND	37x320	1*1/4
280810.042	MGF DIAMONND	42x320	1*1/4
280810.052	MGF DIAMONND	52x320	1*1/4
280810.057	MGF DIAMONND	57x320	1*1/4
280810.062	MGF DIAMONND	62x320	1*1/4
280810.068	MGF DIAMONND	68x320	1*1/4
280810.072	MGF DIAMONND	72x320	1*1/4
280810.082	MGF DIAMONND	82x320	1*1/4
280810.092	MGF DIAMONND	92x320	1*1/4

Vörunúmer	Gerð	mm	*
280810.102	MGF DIAMONND	102x320	1*1/4
280810.107	MGF DIAMONND	107x320	1*1/4
280810.112	MGF DIAMONND	112x320	1*1/4
280810.132	MGF DIAMONND	132x320	1*1/4
280810.142	MGF DIAMONND	142x320	1*1/4
280810.152	MGF DIAMONND	152x320	1*1/4
280810.162	MGF DIAMONND	162x320	1*1/4
280810.182	MGF DIAMONND	182x320	1*1/4
280810.202	MGF DIAMONND	202x320	1*1/4



LOFT&RAFTÆKI



Taktu mynd af QR kóðanum og skoðaðu **Handbók 2024** í símanum



LOFT&RAFTÆKI
loft.is



Vatnsorka
vatnsorka.is



Hjallabrekka 1 - Dalbrekkumegin | 200 Kópavogur | S: 564 3000